

Dual Digital Display Type Fiber Optic Amplifiers

■ Features

● Upgraded features

- Anti-saturation setting function prevents malfunction by saturated light
- Added ultra long distance mode (10ms) of response speed
- Easy sensitivity setting
- Dual-display for light incident level and setting value (BF5□-D)
- Enables to detect the minute object with 1/10,000 high resolution
- Enables to detect with high-speed (20,000 times per sec.) moving objects
- 5 response speeds
 - : Ultra fast mode (50μs), High speed mode (150μs), Standard mode (500μs), Long distance mode (4ms), Ultra long distance mode (10ms)
- Long lasting amplifier regardless of element's life degradation or temperature change
- Multiple sensitivity setting modes available
 - : auto tuning, 1 point (maximum sensitivity), 2 point, positioning teaching
- Up to 8 units enable to connect with mutual interference prevention function using side connectors
- Auto channel setting function for multiple installations
- Adopts red, green, blue light sources for various environment
- Slim design (W10×H30×L70mm)

Upgrade



⚠ Please read "Caution for your safety" in operation manual before using.



■ Specifications

Display type	Dual Display type			Single Display type
Model	NPN open collector output BF5R-D1-N	BF5G-D1-N	BF5B-D1-N	BF5R-S1-N
	PNP open collector output BF5R-D1-P	BF5G-D1-P	BF5B-D1-P	BF5R-S1-P
Light source	Red LED (660nm, modulated)	Green LED (530nm, modulated)	Blue LED (470nm, modulated)	Red LED (660nm, modulated)
Power supply	12-24VDC±10%			
Current consumption	Max. 50mA			
Operation mode	Light ON / Dark ON Selectable			
Control output	NPN or PNP open collector ●Load voltage: Max. 24VDC ●Load current: Max. 100mA ●Residual voltage - NPN:Max. 1V, PNP:Max. 3V			
Protection circuit	Reverse polarity protection, overcurrent protection, surge absorption			
Response time	Ultra Fast: 50μs, Ultra Long: 10ms (only for dual display type), Fast: 150μs, STD: 500μs, Long: 4ms			
Display method	●Incident light level: Red, 4digit, 7Segment ●SV: Green, 4digit, 7Segment ●Main output indicator: Red LED			●Incident light level / SV: Red, 4digit, 7Segment ●Main output indicator: Red LED
Display function	Incident light level / SV display [4,000/10,000 resolution], Percentage display, High/Low peak value display, Normal / Reversed display (only for dual display type)			
Sensitivity setting	Manual sensitivity setting, teaching sensitivity setting (Auto tuning, 1 point, 2 point teaching, positioning teaching)			Manual sensitivity setting, teaching sensitivity setting (auto tuning)
Mutual interference prevention	Max. 8 unit sets (Automatically set regardless of response time)			
Initializing	Initializing as factory mode			—
Energy saving	Normal / Energy saving 1 / Energy saving 2			—
Timer	OFF, OFF Delay, ON Delay, One-shot			OFF, 10ms OFF Delay timer, 40ms OFF Delay timer
Insulation resistance	Min. 20MΩ (at 500VDC megger)			
Dielectric strength	1,000VAC 50/60Hz for 1 min.			
Vibration	1.5mm amplitude at frequency of 10 to 55Hz (for 1 min.) in each X, Y, Z direction for 2 hours			
Shock	500m/s ² (approx. 50G) in each X, Y, Z direction for 3 times			
Environment	Ambient illumination	Incandescent lamp: Max. 3000lx Sunlight: Max. 11000lx (received illumination)		
	Ambient temperature	-10 to 50°C, storage: -20 to 70°C		
	Ambient humidity	35 to 85%RH, storage: 35 to 85%RH		
Protection structure	IP40 (IEC standards)			
Material	Case: PBT, Cover: PC			
Fiber cable Tightening torque	Min. 2kgf			
Accessory	Connector type wire (Ø4mm, 3-wire, length: 2m) (AWG22, Core diameter: 0.08mm, Number of cores: 60, Insulator out diameter: Ø1.25mm), Side connector			
Approval	CE			
Weight ^{※1}	Approx. 138g (approx. 20g)			

※1: The weight includes packaging. The weight in parentheses is for unit only.

※The temperature or humidity mentioned in Environment indicates a non freezing or condensation environment.

(A) Photoelectric Sensors

(B) Fiber Optic Sensors

(C) Door/Area Sensors

(D) Proximity Sensors

(E) Pressure Sensors

(F) Rotary Encoders

(G) Connectors/ Sockets

(H) Temperature Controllers

(I) SSRs / Power Controllers

(J) Counters

(K) Timers

(L) Panel Meters

(M) Tacho / Speed / Pulse Meters

(N) Display Units

(O) Sensor Controllers

(P) Switching Mode Power Supplies

(Q) Stepper Motors & Drivers & Controllers

(R) Graphic/ Logic Panels

(S) Field Network Devices

(T) Software

BF5 Series

Control Output Diagram

• NPN open collector output

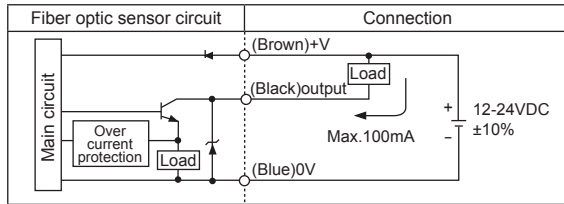

• PNP open collector output

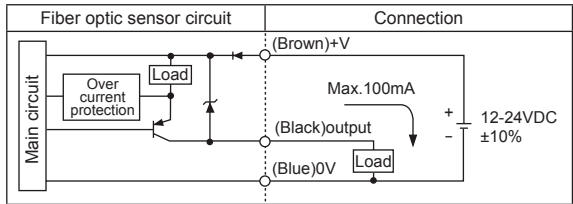

Dimensions

(unit: mm)

• BF5□-D1-□



• BF5R-S1-□

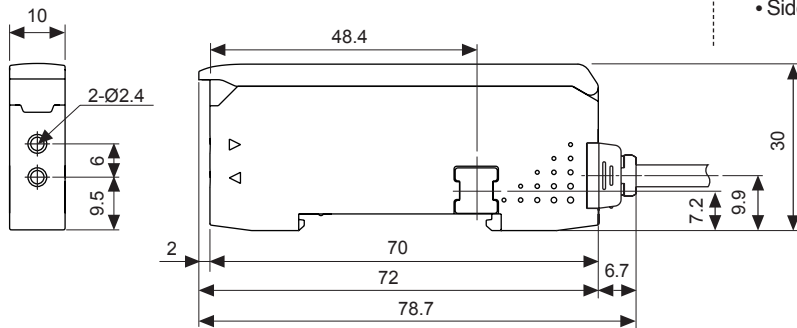
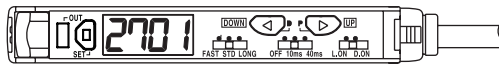

• Accessories

- Connector type wire (length: 2m)

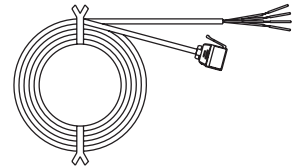

- Side connector



Installations

⊙ Amplifier unit mounting

- Installation: Hang up the backside holder on the DIN rail and press the unit toward the DIN rail.
- Removal: Slide the back part of the unit as the ① figure and lift up the unit as the ② figure.

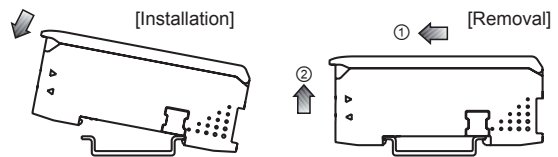

⊙ Amplifier unit connection

- Remove the side cover at the connecting side as the figure ① and connect the side connector as the figure ②.
- ※Be sure that if you connect a side connector with excessive force, it may cause extruded pins.
- After mounting the unit on the DIN rail, push gently both units to fasten each other.
- ※Make sure that connections between the unit case and connectors are correct. Improper connection may cause malfunction of channel setting and mutual interference prevention functions.
- ※Do not supply the power while connecting / disconnecting amplifier units.

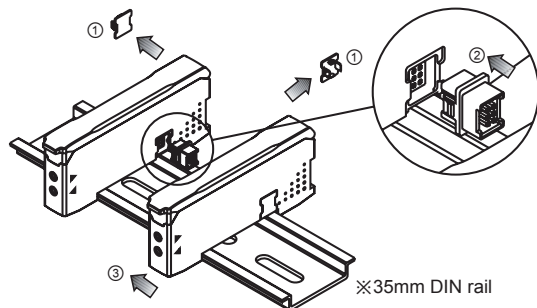

Fiber Optic Amplifier

◎ Fiber cable connection

- Lift up the protective cover ① and push down the lock lever to the direction of ② to release the lock setting.
- Insert the cable to the direction of ③ with slightly moving up and down 15°, and gently press into the unit until the cable is completely inserted (inserted length: around 13mm).
- Lift up the lock lever to lock the lock setting ④ and close the protective cover to ⑤.

◎ Wire connector connection

- Insert the connector into the amplifier unit until it clicks into right position.
- When removing the connector, pull out the connector to the ① direction by pressing the lever downside to the ② direction.

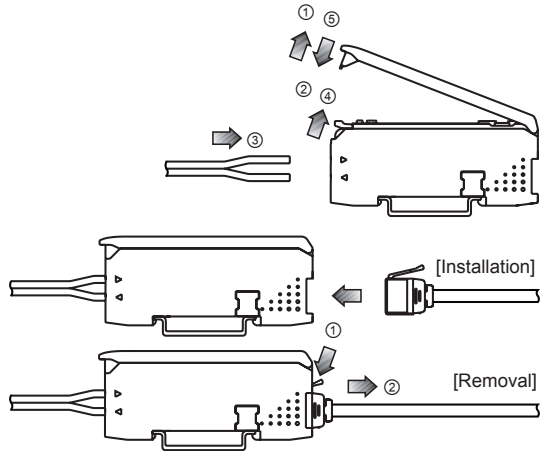

■ Unit Descriptions

● BF5□-D1-□



- Control output indicator (Red)**
: Used to indicate control output provided by comparing SV and actual incident light level
- Sensitivity setting key**
: Used to execute each operation and to set sensing sensitivity
- PV display part (4 Digit, Red, 7 segments)**
: Used to indicate incident light level and parameters
- SV display part (4 Digit, Green, 7 segments)**
: Used to indicate SV and setting data
- Up/down key**
 - Used to up/down setting values
 - Used to Fine-adjusting sensitivity
- MODE key**
 - Used to enter into program mode / data Bank mode
 - Used to move each parameter

● BF5R-S1-□

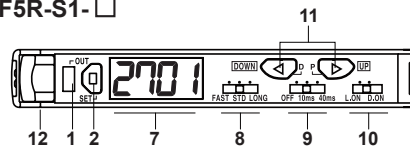

- PV/SV display part (4 Digit, Red, 7 segments)**
: Used to indicate incident light level / SV and parameters
- Response time setting switch: FAST, STD, LONG**
- Timer setting switch**
: Used to select OFF Delay time (OFF, 10ms, 40ms)
- Operation mode setting switch**
: Used to select Light ON / Dark ON
- Up/Down key**
 - Used to up/down setting values
 - Used to enter into each mode
 - Used to Fine-adjusting sensitivity
- Lock lever**

■ Parameter Setting

● BF5□-D1-□

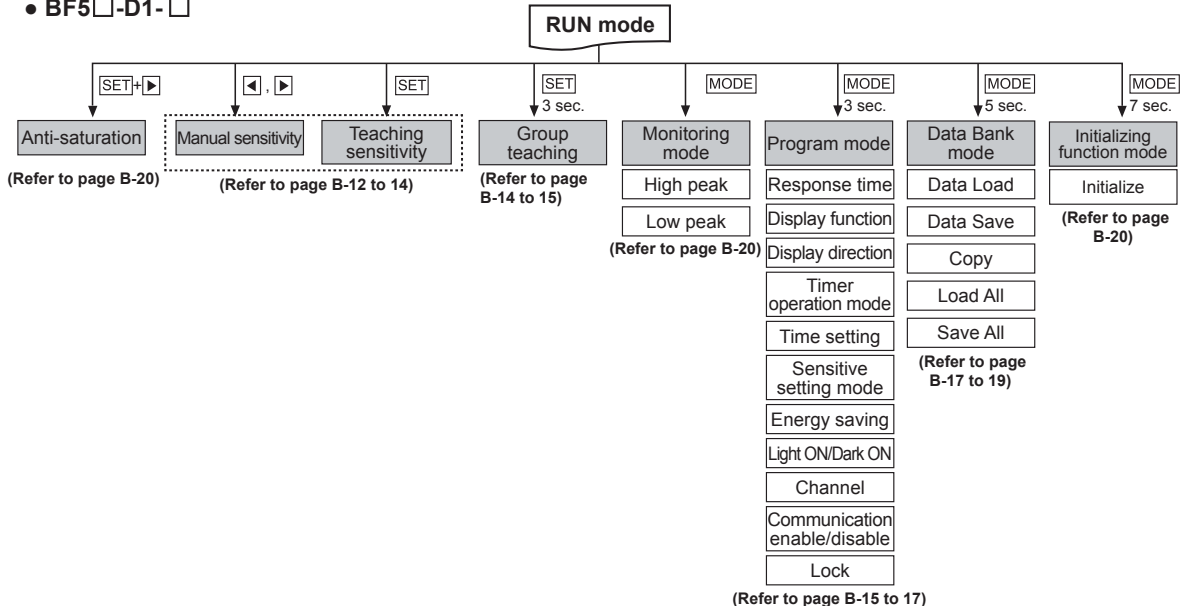

(A) Photoelectric Sensors

(B) Fiber Optic Sensors

(C) Door/Area Sensors

(D) Proximity Sensors

(E) Pressure Sensors

(F) Rotary Encoders

(G) Connectors/ Sockets

(H) Temperature Controllers

(I) SSRs / Power Controllers

(J) Counters

(K) Timers

(L) Panel Meters

(M) Tacho / Speed / Pulse Meters

(N) Display Units

(O) Sensor Controllers

(P) Switching Mode Power Supplies

(Q) Stepper Motors & Drivers & Controllers

(R) Graphic/ Logic Panels

(S) Field Network Devices

(T) Software

BF5 Series

• BF5R-S1-□

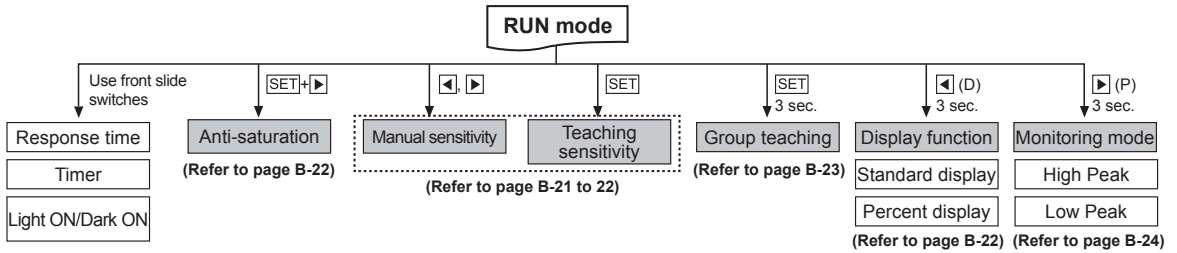

Dual display type (※Refer to page B-12 to 20.)

■ Sensitivity Setting Mode

※There are two methods available for sensitivity setting - manual/teaching sensitivity setting.
Select the method most suitable for your application.

⊙ Manual sensitivity setting (Fine-adjusting sensitivity)

- The setting is to set the sensitivity manually.
- Used to fine-adjusting sensitivity after the teaching sensitivity setting.
- Incident light level is still displayed on the PV display part during setting.



- ① Press the <> and > keys to set the value.
- ② There is no additional key for completing the setting. After completing setting and no key input for 3 sec, let set value flashing twice (every 0.5 sec) and automatically it saved and returned to RUN mode.

⊙ Teaching sensitivity setting (Auto-tuning, One-point, Two-point, Positioning)

- How to enter into sensitivity setting mode in RUN mode
Press the [SET] key once and teaching starts automatically.
When teaching is completed, this unit returns to RUN mode automatically.
- The PV display part displays the set teaching mode parameter and the SV display part displays the progressing status while teaching is in the process.
※If there is no key operation for 60 sec after entering into teaching mode, it automatically returns to RUN mode.

1) Auto-tuning

※Suitable when unstable incident light level of sensing object or when sensing fast moving objects.
※Auto-tune automatically sets the sensitivity by using the average value of the incident light level within a certain period.

$$\text{Set_value} = \frac{P1+P2+\dots+Pn-1+Pn}{n}$$

- Set Teaching mode parameter[SEn5] to AUTO.

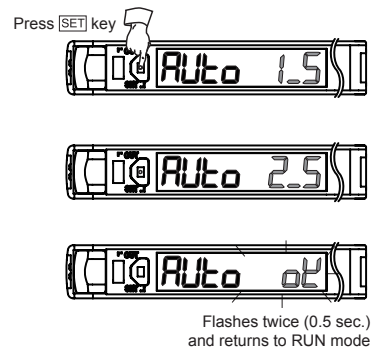
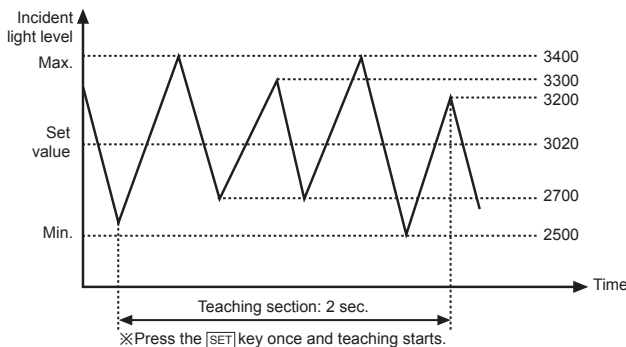

2) One-point teaching mode

※ One of teaching modes that sets the maximum sensitivity by teaching one sensitivity setting point when setting the SV with no sensing object (Reflective) or when setting the SV with incident light level 0 (Through-beam) / Suitable for the applications no effect of dust or background.

- Set Teaching mode parameter [SEn5] to 1Pnt.

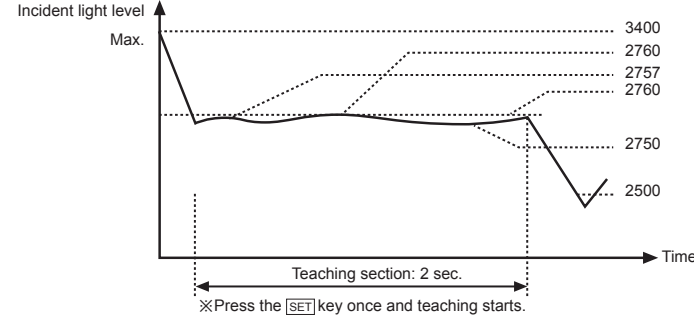

Flashes twice (0.5 sec.) and returns to RUN mode

※ SV range for sensing distance.

Response Time	Teaching when incident light level is 0	Teaching when incident light level is saturated
UF5t	In case incident light level is 0, set to 10 digit.	In case incident light level is saturated, set to 3980 digit.
F5t		
St d		
LoG	In case incident light level is 0, set to 5 digit.	In case incident light level is saturated, set to 9980 digit.
ULoG		

3) Two-point teaching mode

※ Suitable when incident light level is stable or when sensing object is slow or at stopped position.

※ One of teaching modes that sets the sensitivity by using average value of two incident light levels obtained from two point teaching - one point with a sensing object and another point without a sensing object.

- Set Teaching mode parameter [SEn5] to 2Pnt.

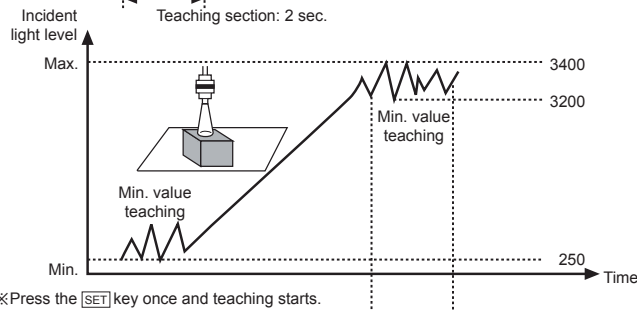
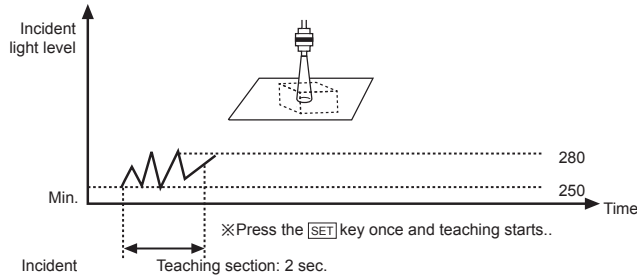

※ Press the [SET] key once and teaching starts.

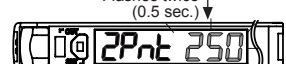
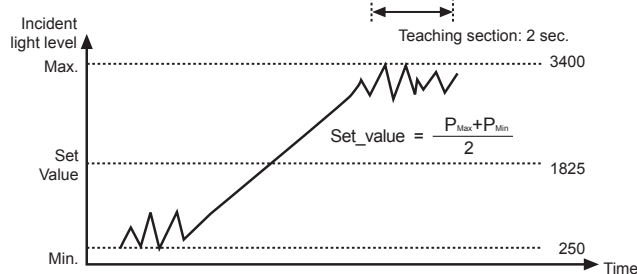

Flashes twice (0.5 sec.)



Flashes twice (0.5 sec.)

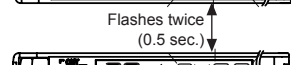

Flashes twice (0.5 sec.) and returns to RUN mode

※ Make sure that two point teaching must be done within 60 sec after one point teaching. If not, teaching mode is cancelled and it returns to RUN mode.

(A) Photoelectric Sensors

(B) Fiber Optic Sensors

(C) Door/Area Sensors

(D) Proximity Sensors

(E) Pressure Sensors

(F) Rotary Encoders

(G) Connectors/ Sockets

(H) Temperature Controllers

(I) SSRs / Power Controllers

(J) Counters

(K) Timers

(L) Panel Meters

(M) Tacho / Speed / Pulse Meters

(N) Display Units

(O) Sensor Controllers

(P) Switching Mode Power Supplies

(Q) Stepper Motors & Drivers & Controllers

(R) Graphic/ Logic Panels

(S) Field Network Devices

(T) Software

BF5 Series

4) Positioning teaching mode

※One of teaching modes that sets the sensitivity by 90% of max. incident light level when sensing an object with a hole on the surface (Through-beam) or sensing a moving object with curve (Reflective).

- Set Teaching mode parameter [SEn5] to P5En.

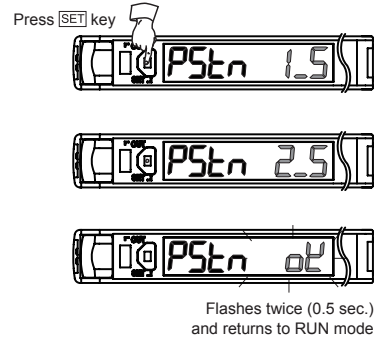
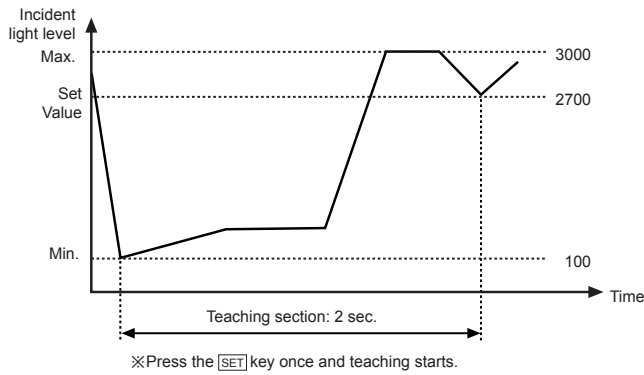

■ Group Teaching mode

A function to set the sensitivity of Slave amplifier units according to the command of Master amplifier unit (a certain amplifier unit) in a successive and collective way.

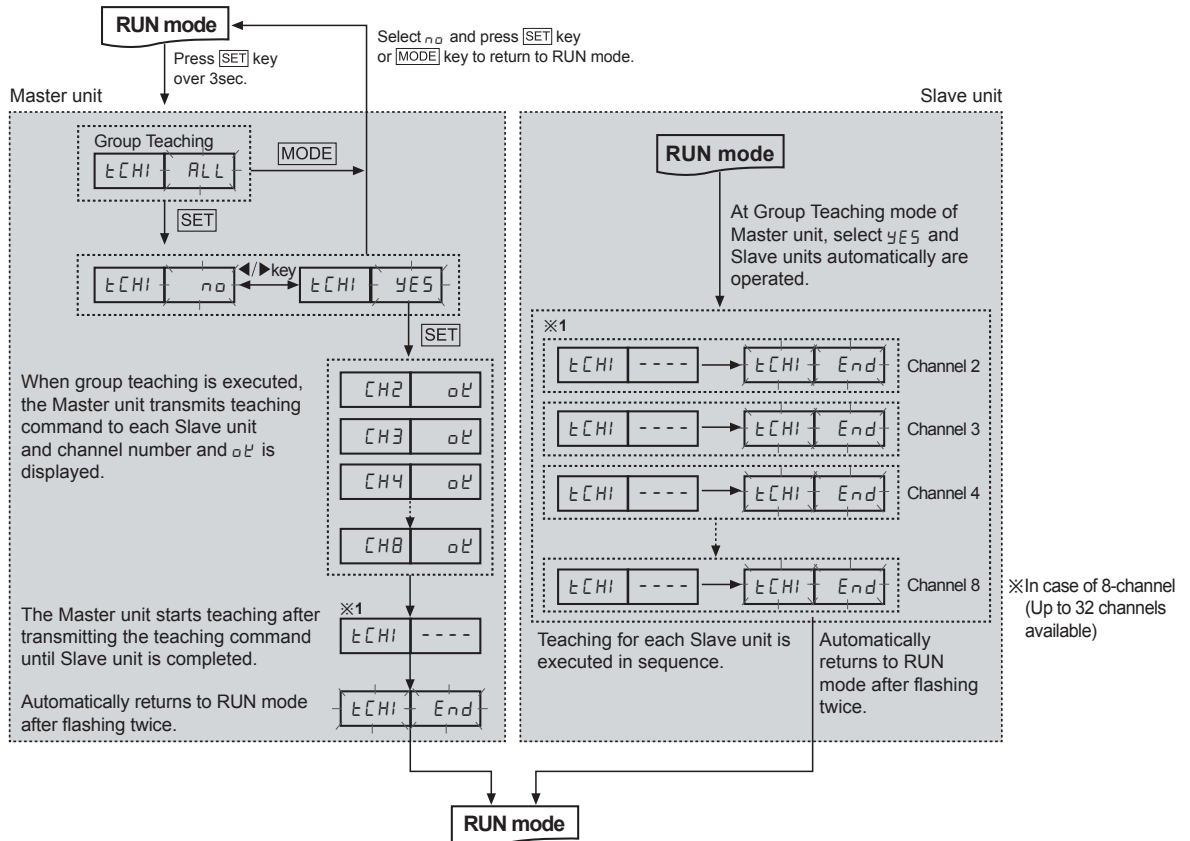

※1: Display part status while teaching is in the process

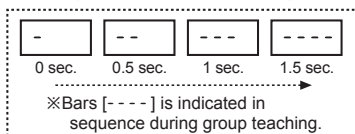

Master / Slave unit display during group teaching mode

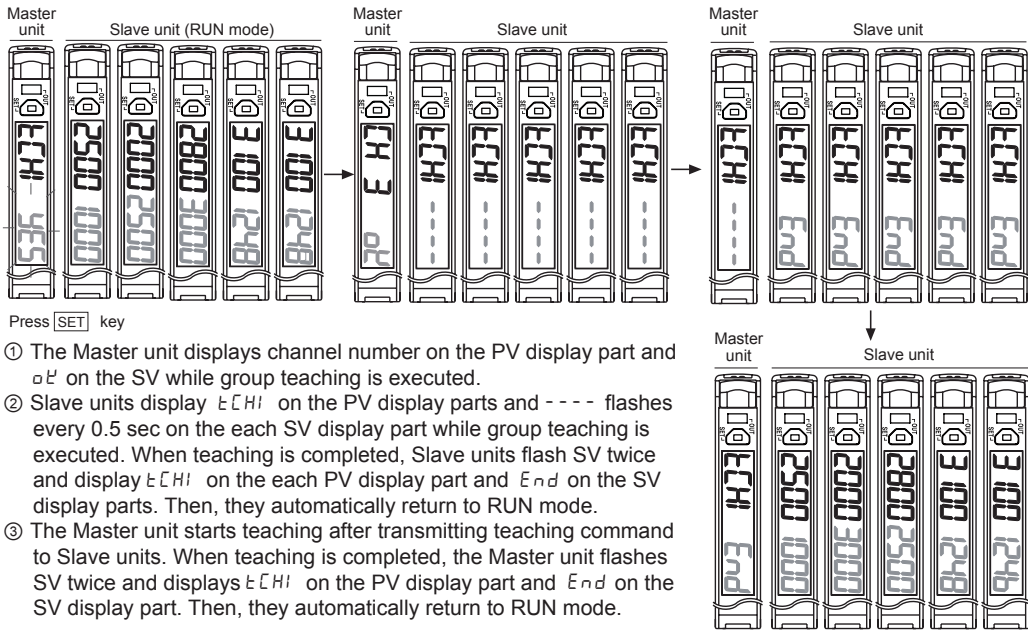

Program Mode Setting

- When entering into program mode, parameters lights ON on the PV display part and setting values flashes every 0.5 sec. on SV display part. Use the \leftarrow , \rightarrow keys to set each setting value.
- Press the **MODE** key one time after setting each parameter to save each setting and enter into next mode.
- If the key lock is set, unlock the key lock before setting parameters.

Program mode flow

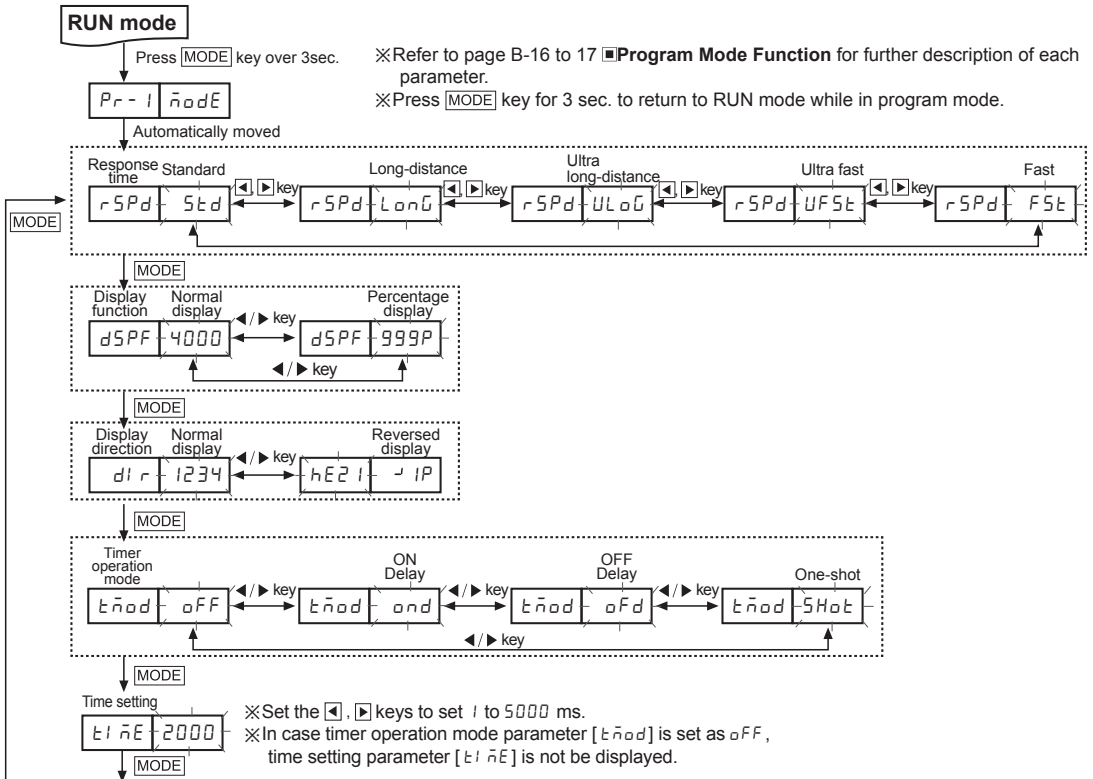

(A) Photoelectric Sensors

(B) Fiber Optic Sensors

(C) Door/Area Sensors

(D) Proximity Sensors

(E) Pressure Sensors

(F) Rotary Encoders

(G) Connectors/ Sockets

(H) Temperature Controllers

(I) SSRs / Power Controllers

(J) Counters

(K) Timers

(L) Panel Meters

(M) Tacho / Speed / Pulse Meters

(N) Display Units

(O) Sensor Controllers

(P) Switching Mode Power Supplies

(Q) Stepper Motors & Drivers & Controllers

(R) Graphic/ Logic Panels

(S) Field Network Devices

(T) Software

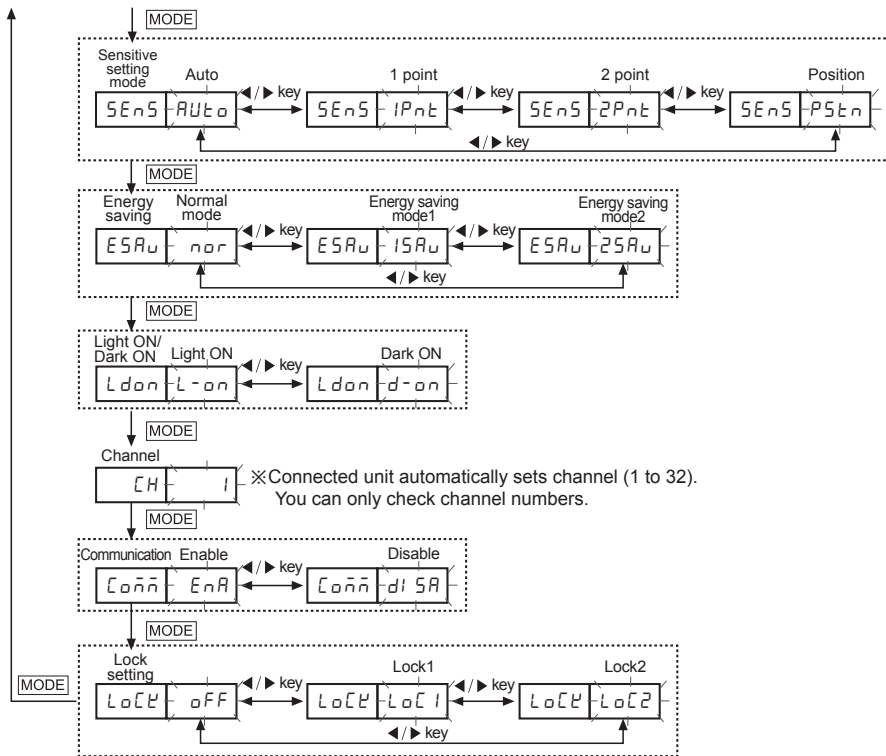

■ Program Mode Function

◎ Response time setting [rSPd]

A function to set the response time of control output - 4 response modes selectable.

- Ultra fast [UFSt] mode: 50μs
- Fast [FSt] mode: 150μs
- Standard [Std] mode: 500μs
- Long-distance [Ldnc] mode: 4ms
- Ultra long-distance [ULdc] mode: 10ms

◎ Display function [dSPF]

A function to select incident light level display mode on PV display window: Standard display [4000] / Percentage display [999P]

- Display range of standard mode: 0 to 4000 (0 to 9999, in case of long distance mode)
- Display range of percentage mode: 0P to 999P (Decimal point is not displayed)

◎ Display direction setting function [dlr]

A function to reverse the display direction to suit the unit in the location for installation: Normal display / Reversed display selectable.

※Reversed display is upside-down (180°) display of normal display.

◎ Timer function [Timer operation mode: tnd, Time setting: tl nE]

Used when external device's response time is too late or when control output time is too short due to small sensing object - 3 modes are available.

- Timer Off [off]
- On Delay [ond]: Delays control output ON time from OFF for a certain period of setting time
- Off Delay [ofd]: Delays control output OFF time from ON for a certain period of setting time
- One-shot [shot]: Turns control output ON or OFF within a certain period of setting time
- Setting time [tl nE]: 1 to 5000ms

• Time chart

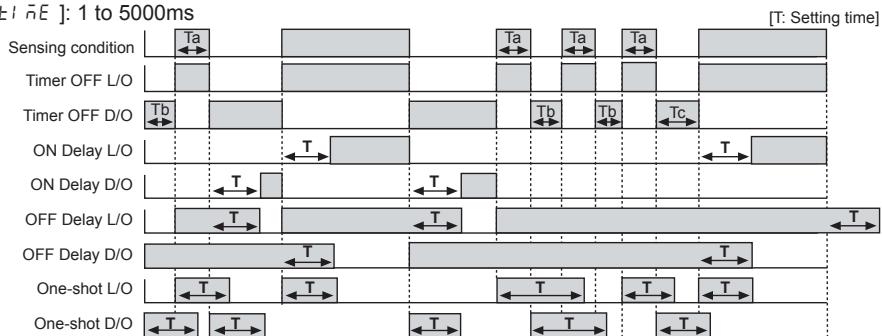

※Setting time: $T > T_a$, $T > T_b$, $T > T_c > T_b$

⊙ Energy saving function [E5A_U]

A function to save unit's power consumption by reducing power supply to display parts in case of no setting input within 60 sec.

- Selectable from 2 power saving modes
- Normal mode [n_or]: Main output indicator (OUT), PV/SV display part ON
- Energy saving mode 1 [15A_U]: Main output indicator (OUT) and PV display part ON
- Energy saving mode 2 [25A_U]: Main output indicator (OUT) ON

⊙ Light ON / Dark ON switching function [Ld_on]

A function to set Light ON - control output is ON when incident light level is higher than setting value Dark ON - control output is ON when incident light level is lower than setting value.

⊙ Communication enable / disable setting function [C_om_on]

A function to set communication write [enable (E_nA)] / disable (d_i5A)] for Slave amplifier units while certain instructions (Load/Save/Copy) or Group teaching is in progress by the Master amplifier unit.

⊙ Lock function [L_ock]

Two types of key lock setting are available in order to prevent SV changes by careless.

	oFF	L _o ck 1	L _o ck 2
Sensitivity setting	●	◐	◐
Data Bank mode	●	○	○
Program mode	●	◐	○
Parameter initialization	●	○	○

- ※●: Check / Setting both available
- ◐: Check available
- : Check / Setting both unavailable

- In case of [L_ock 2] mode, it is not available to use the lock function first to enter into parameter mode.

■ Data Bank Setting

A function to save settings for group amplifier units in each data Bank by using Master unit's command or by adjusting one amplifier unit's setting and to load required data Bank without resetting for each unit's parameters and setting values.

- LOAD [L_oAd]: Loads preset data bank (b_ALk, 1, 2) and applies it to the amplifier unit.
Detailed Bank parameters can be read and changed.
 - SAVE [5A_UE]: Saves one amplifier unit settings in one of data bank (b_ALk, 1, 2).
 - COPY [C_oPY]: Copies the currently loaded Bank by Master's instructions to the other amplifier units (1:1) or the whole amplifier units (1: M).
 - LOAD ALL [L_oAL]: Selects one data bank by Master's instructions and loads it to entire group units.
 - SAVE ALL [5_UAL]: Selects one data bank by Master's instructions and saves it in entire group units.
- ※For BF5□-D1□, three data banks are available ([b_ALk], [b_AL 1] and [b_AL 2]) so that three different sensing object information can be saved. Each Bank can be read and changed. It allows users to detect three different sensing objects with one amplifier unit without resetting each parameter.
- ※Data bank function can be executed only if all amplifier units are in RUN mode.
- ※Copy/Load All/Save All functions are applicable only if multiple amplifier units are connected.
- ※If lock function is set (L_ock 1 / L_ock 2) on amplifier units or if the Slave unit is set to communication disable[d_i5A], Load and Save command for the unit is not executed.

(A) Photoelectric Sensors

(B) Fiber Optic Sensors

(C) Door/Area Sensors

(D) Proximity Sensors

(E) Pressure Sensors

(F) Rotary Encoders

(G) Connectors/ Sockets

(H) Temperature Controllers

(I) SSRs / Power Controllers

(J) Counters

(K) Timers

(L) Panel Meters

(M) Tacho / Speed / Pulse Meters

(N) Display Units

(O) Sensor Controllers

(P) Switching Mode Power Supplies

(Q) Stepper Motors & Drivers & Controllers

(R) Graphic/ Logic Panels

(S) Field Network Devices

(T) Software

BF5 Series

◎ Data Bank mode flow

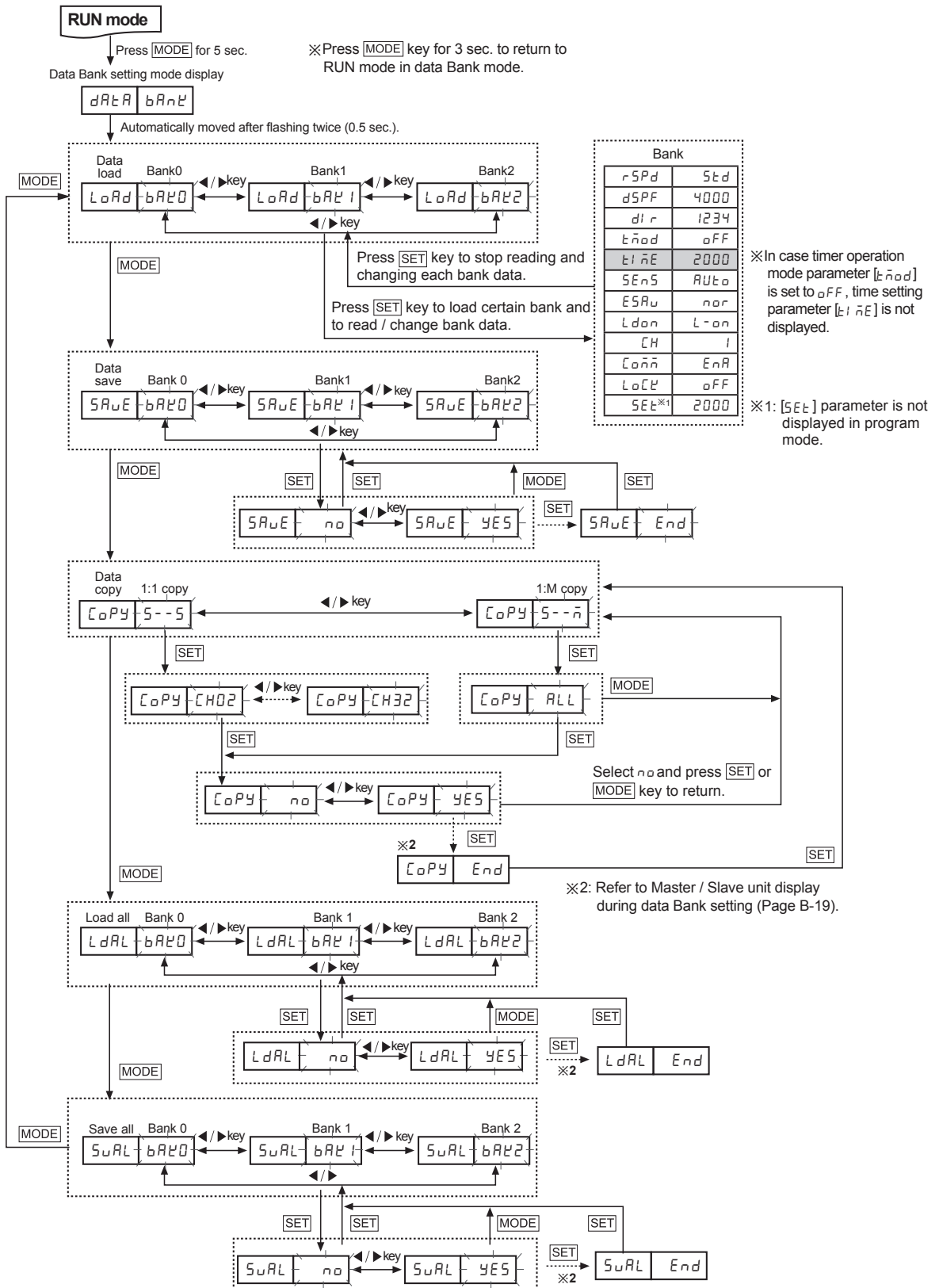

◎ Master / Slave unit display during data Bank setting

● Copy All

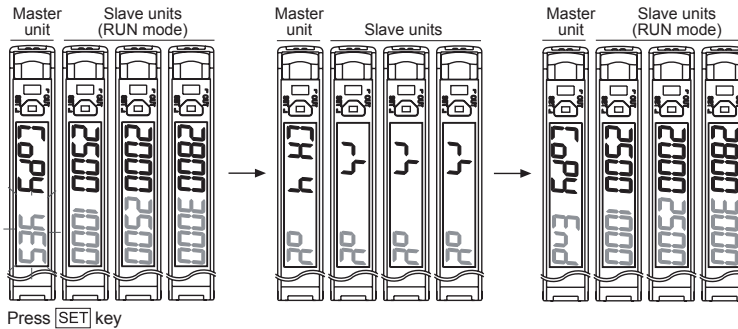

- ① While Copy All is executed, the Master unit displays the channel number on the PV display part and 00 on the SV display part.
- ② While Copy All is executed, the Slave units display 70 on the PV display part and 00 on the SV display part and they return to RUN mode.
- ③ When Copy All is completed, the Master unit displays COPY on the PV display part and End on the SV display part. Press the SET key to return to Data Copy mode. ※In case of 1:1 Copy, it progresses likewise.

● Load All

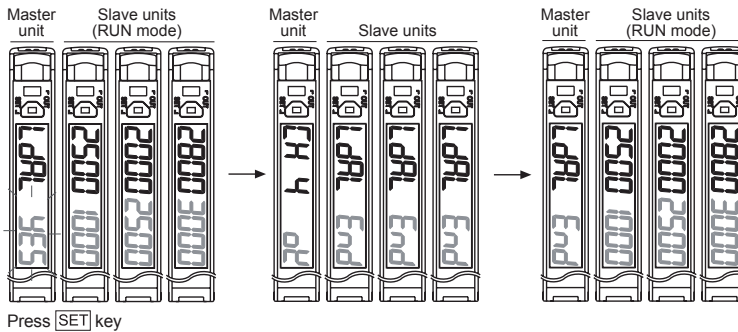

- ① While Load All is executed, the Master unit displays the channel number on the PV display part and 00 on the SV display part.
- ② While Load All is executed, the Slave units display LDRL on the PV display part and End on the SV display part and they return to RUN mode.
- ③ When Load All is completed, the Master unit displays LDRL on the PV display part and End on the SV display part. Press the SET key to return to Load All mode.

● Save All

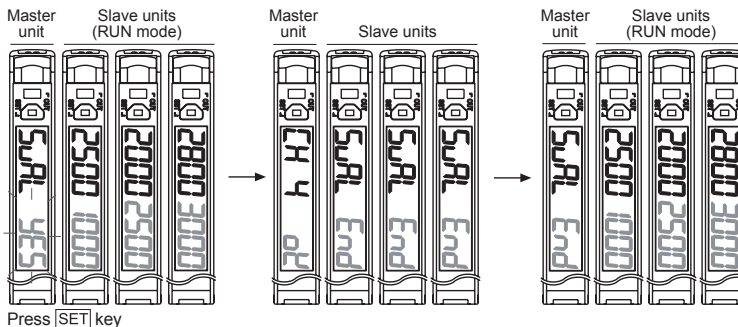

- ① While Save All is executed, the Master unit displays the channel number on the PV display part and 00 on the SV display part.
- ② While Save All is executed, the Slave units display SURL on the PV display part and End on the SV display part and they return to RUN mode.
- ③ When Save All is completed, the Master unit displays SURL on the PV display part and End on the SV display part. Press the SET key to return to Save All mode.

※If communication write enable / disable parameter [C0nn] for the Slave unit is set to disable dI 5R while Save All, Load All or Copy is executed, the master unit displays channel number on the PV display part and dI 5R on the SV display part.

(A) Photoelectric Sensors

(B) Fiber Optic Sensors

(C) Door/Area Sensors

(D) Proximity Sensors

(E) Pressure Sensors

(F) Rotary Encoders

(G) Connectors/ Sockets

(H) Temperature Controllers

(I) SSRs / Power Controllers

(J) Counters

(K) Timers

(L) Panel Meters

(M) Tacho / Speed / Pulse Meters

(N) Display Units

(O) Sensor Controllers

(P) Switching Mode Power Supplies

(Q) Stepper Motors & Drivers & Controllers

(R) Graphic/ Logic Panels

(S) Field Network Devices

(T) Software

■ Anti-Saturation Setting Function

- When the sensing target comes too close and it is saturation status, this function changed to the optimize status.
- Press the **[SET+▶]** keys one time and anti-saturation function is operated automatically. There are max. 10 levels.
- Press the **[SET+▶]** keys one time again and anti-saturation function is cleared.
- During anti-saturation, the SV display part displays current level.
- When response mode is ultra fast [*UF5t*], fast [*F5t*] or standard [*5td*] and incident light level is lower than 2200, this function is cleared and this unit returns RUN mode automatically. When response mode is long distance [*L0nG*], ultra long distance [*UL0G*] and incident light level is lower than 5500, this function is cleared and this unit returns RUN mode automatically.

※ This function is not operated when incident light level is lower by each mode (*UF5t, F5t, 5td*: 2200, *UL0G, L0nG*: 5500).

※ If saturation status is too high and it does not reach the target value, it stops at level 10 and this unit returns RUN mode.

※ When anti-saturation function is set, control output operation may be changed.

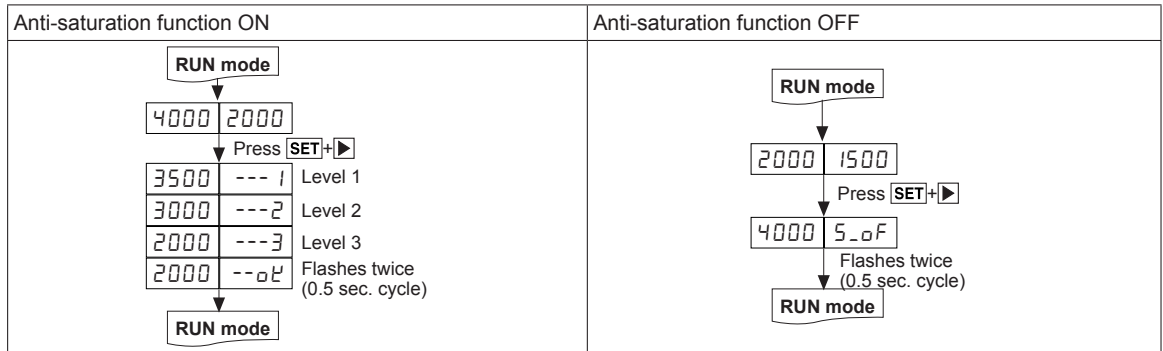

■ High Peak, Low Peak Function

A function to monitor the high/low peak value of incident light level. The monitored high/low peak value can be initialized.

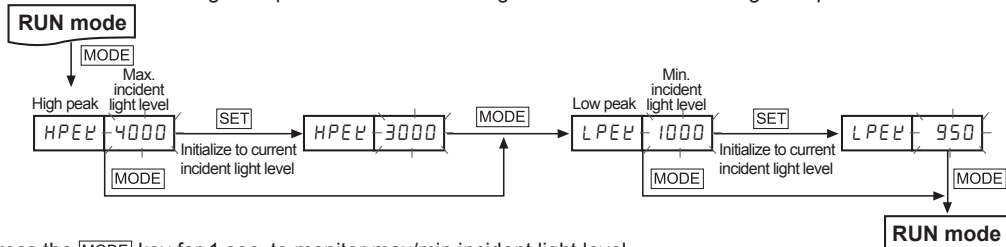

- ① Press the **[MODE]** key for 1 sec. to monitor max/min incident light level.
- ② Press the **[MODE]** key to initialize max/min value to current incident light level during monitoring.
- ③ Press the **[MODE]** key to return to RUN mode.

■ Initializing Function

A function to initialize all parameters about default value in case of mis-setting or mis-operation.

※ Set lock function [*L0cK*] to *oFF* to execute Initializing Function.

※ High peak value [*HPEL*] and low peak value [*LPEL*] shall not be initialized.

◎ Parameter initialize flow

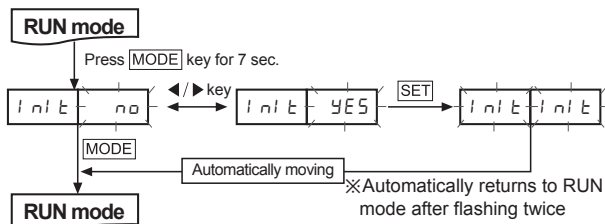

- ① Press the **[MODE]** key for 7 sec. in RUN mode. *i n i t* parameter turns ON on PV display part and *n o* flashes every 0.5sec. on SV display part.
- ② Press the **[MODE]** key once again to return to RUN mode without executing initializing Function.
- ③ Select *9E5* using the **[◀]**, **[▶]** keys and press the **[SET]** key. *i n i t* flashes twice on both PV and SV display parts.
- ④ When parameter initialization is completed, it automatically returns to RUN mode.

◎ Parameter value for initialization (factory default)

Parameter	Factory default	Parameter	Factory default	Parameter	Factory default
<i>r5Pd</i>	<i>5td</i>	<i>t n o d</i>	<i>oFF</i>	<i>L d o n</i>	<i>L - o n</i>
<i>d5PF</i>	4000	<i>SEn5</i>	<i>AUto</i>	<i>C o n n</i>	<i>EnR</i>
<i>d1r</i>	1234	<i>ESRu</i>	<i>noR</i>	<i>L o c k</i>	<i>oFF</i>

SV: 2000, Bank 0 to 2: Initialized

(A)	Photoelectric Sensors
(B)	Fiber Optic Sensors
(C)	Door/Area Sensors
(D)	Proximity Sensors
(E)	Pressure Sensors
(F)	Rotary Encoders
(G)	Connectors/ Sockets
(H)	Temperature Controllers
(I)	SSRs / Power Controllers
(J)	Counters
(K)	Timers
(L)	Panel Meters
(M)	Tacho / Speed / Pulse Meters
(N)	Display Units
(O)	Sensor Controllers
(P)	Switching Mode Power Supplies
(Q)	Stepper Motors & Drivers & Controllers
(R)	Graphic/ Logic Panels
(S)	Field Network Devices
(T)	Software

Single display type (※Refer to page B-20 to 22.)

■ Sensitivity Setting Mode

※There are two methods available for sensitivity setting - manual or teaching mode.
Select the most suitable method for your application.

◎ Manual sensitivity setting (Fine-adjusting sensitivity)

- The setting is to set the sensitivity manually.
- Used to fine-adjust sensitivity after the teaching sensitivity setting.
- Incident light level is still displayed on the PV/SV display part during SV setting.

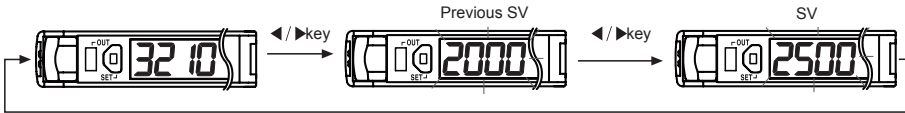

- ① Press the ◀ or ▶ key once in RUN mode, then previous SV flashes twice (every 0.5 sec.).
- ② Press the ◀ and ▶ keys to set the value.
- ③ There is no additional key for completing the setting. If there is no key input for 3 sec after completing setting, newly set value flashes twice (every 0.5 sec) and automatically is saved and it returns to RUN mode.

◎ Teaching sensitivity setting (Auto tuning)

- For BF5R-S1- □ model, teaching sensitivity setting mode is fixed to auto-tuning.
- ※This mode is easy for the sensitivity when incident light level of sensing object is not stable or moves fast.
- ※One of teaching modes that sets the sensitivity by using average value of the maximum and minimum incident light level within a certain period.

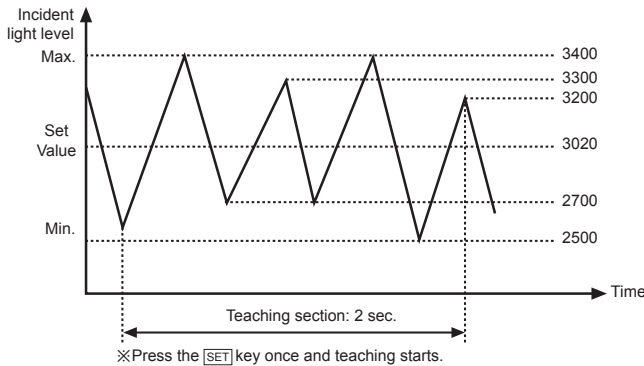

$$\text{Set_value} = \frac{P1+P2+ \dots +Pn-1+Pn}{n}$$

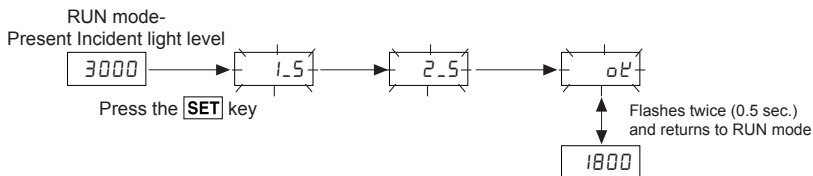

- ① In RUN mode, press the [SET] key once with the desired sensing target.
- ② When pressing the [SET] key once, and teaching starts and is progressed automatically for 2 sec.
- ③ After completing teaching, 0.0 is flashes twice for 0.5 sec. and it returns to RUN mode.

BF5 Series

Function

Response time setting

Use front slide switch to set response time.

- Fast (FAST) mode: 150 μ s
- Standard (STD) mode: 500 μ s
- Long distance (LONG) mode: 4ms

Display function (Factory mode: standard display)

A function to select incident light level display on display part.

- Display range of standard mode: 0 to 4000 (0 to 9999, in case of long distance mode)
- Display range of percentage mode: 0P to 9.99P (Decimal point is not displayed)

<When changing to standard display mode>

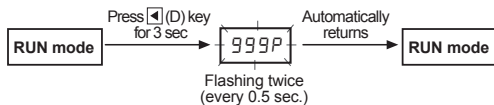

<When changing to percentage display mode>

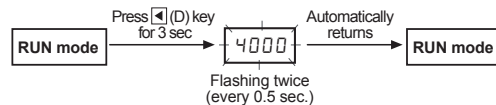

Timer function

※For the BF5R-S1-□ model (single display type), only OFF Delay mode is available. Select the setting time (OFF/10ms/40ms) using the front slide switch.

Time chart

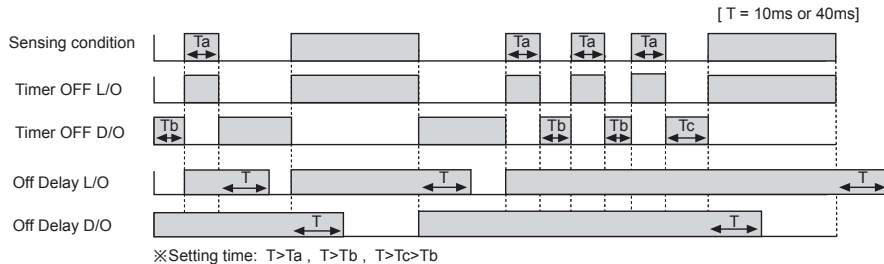

Light ON / Dark ON switching function

A function to set Light ON - control output is ON when incident light level is higher than setting value and Dark ON - control output is ON when incident light level is lower than setting value.

BF5R-S1-□ (Single display type) model uses the front slide switch to set each mode.

Anti-Saturation Setting Function

- When the sensing target comes too close and it is saturation status, this function changed to the optimize status.
- Press the [SET]+[▶] keys one time and anti-saturation function is operated automatically. There are max. 10 levels.
- Press the [SET]+[▶] keys one time again and anti-saturation function is cleared.
- During anti-saturation, the PV/SV display part displays current level.
- When response mode is fast [FST] or standard [STD] and incident light level is lower than 2200, this function is cleared and this unit returns RUN mode automatically. When response mode is long distance [LONG] and incident light level is lower than 5500, this function is cleared and this unit returns RUN mode automatically.
- ※This function is not operated when incident light is lower by each mode (FST, STD: 2200, LONG: 5500).
- ※If saturation status is too high and it does not reach the target value, it stops at level 10 and this unit returns RUN mode.
- ※When anti-saturation function is set, control output operation may be changed.

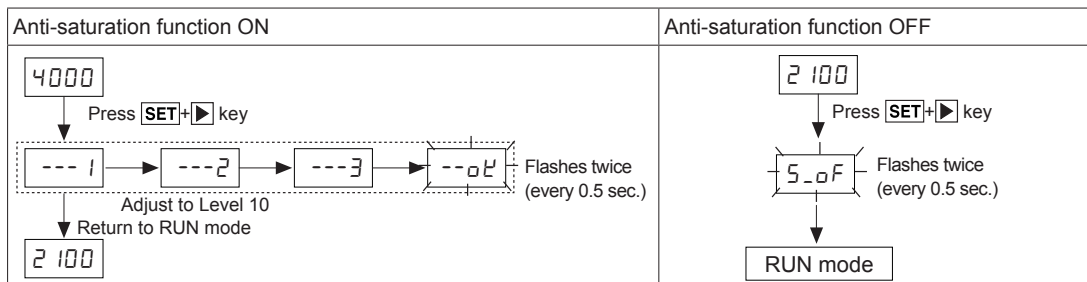

■ Group Teaching

A function to set the sensitivity of Slave amplifier units according to the command of Master amplifier unit (a certain amplifier unit) in a successive and collective way.

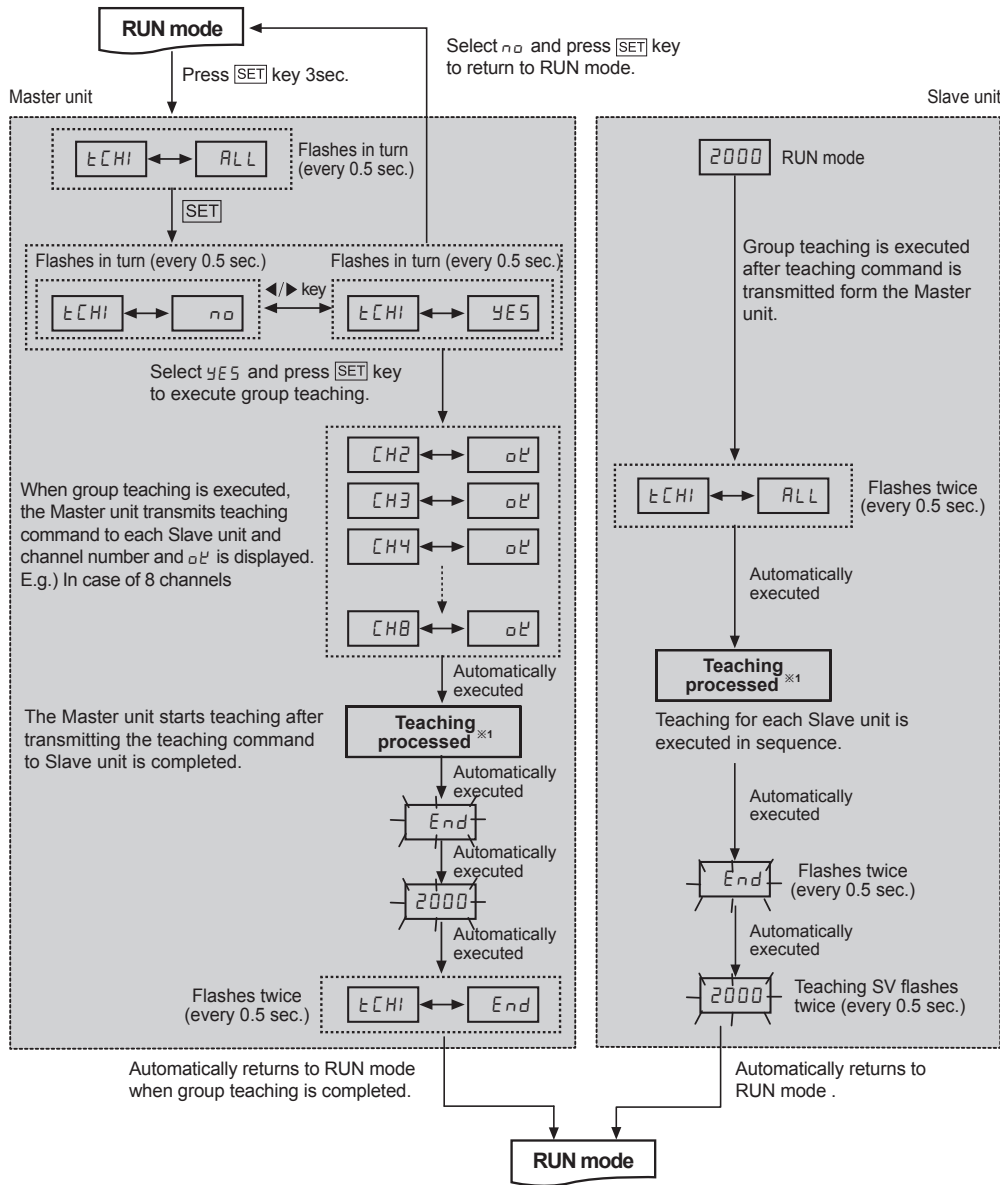

※1: Display part status while teaching is in the process

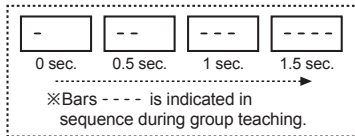

(A) Photoelectric Sensors

(B) Fiber Optic Sensors

(C) Door/Area Sensors

(D) Proximity Sensors

(E) Pressure Sensors

(F) Rotary Encoders

(G) Connectors/Sockets

(H) Temperature Controllers

(I) SSRs / Power Controllers

(J) Counters

(K) Timers

(L) Panel Meters

(M) Tacho / Speed / Pulse Meters

(N) Display Units

(O) Sensor Controllers

(P) Switching Mode Power Supplies

(Q) Stepper Motors & Drivers & Controllers

(R) Graphic/Logic Panels

(S) Field Network Devices

(T) Software

High Peak, Low Peak Function

A function to monitor the high/low peak value of incident light level. The monitored high/low peak value can be initialized.

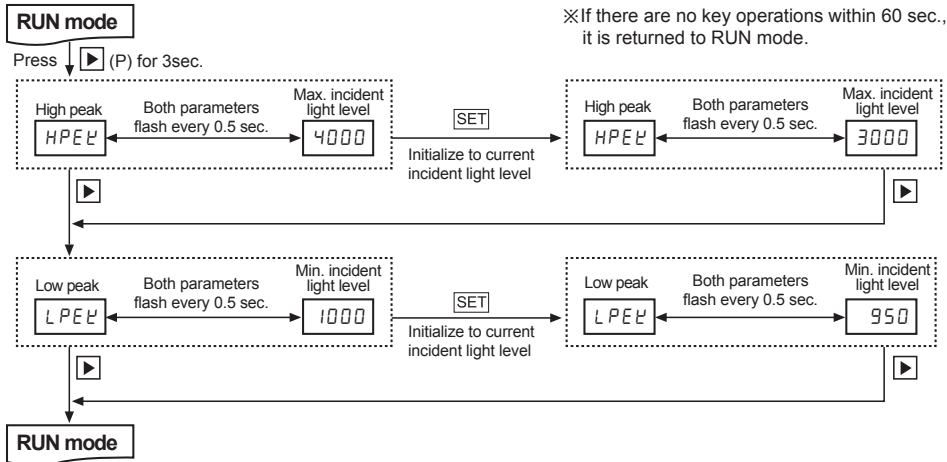

Dual display / Single display common features

Program Mode Function

Amplifier units connection using side connector

In case multiple amplifier units are connected, the power for one unit will be supplied to all connected units.

Auto channel setting function

- The channel for each amplifier unit - connected by side connector - is automatically set in a certain direction (→) as soon as power is supplied. Channel number is increasing one by one.
 - Auto set channel can be checked in channel parameter in program mode.
 - In case of BF5R-S1-□, auto set channel can be checked only when initial power is supplied. (Not available afterwards).
 - Channel range: 1 to 32 (applied the same to all models)
- ※Note that auto set channel cannot be changed and the channel number of each amplifier unit is not saved in case of power OFF.

Mutual Interference Prevention Function

A function to set different light receiving time for each amplifier unit in case of installing the fiber cable adjacently in order to prevent mutual interference occurring. (Set automatically when power is turned ON.)

※Mutual interference function is allowed up to maximum 8 amplifier units regardless of the unit model and response time.

Error Code

Error code	Cause	Troubleshooting
ErrL	In case incident light level is below the min. range when teaching.	Increase the incident light level above min. range.
Err	In case overcurrent inflow occurs into output circuit.	Remove overcurrent through overload.
Errb	<ul style="list-style-type: none"> • In case Slave is failed to execute Master's instructions due to unstable communication line connection during Group Copy / Load / Save / Teaching. • In case other communication errors occur 	<ul style="list-style-type: none"> • Check amplifier unit's connection again. • Check circuit and hardware around side connector.