

A/F 902 - 903

A 902 - 903

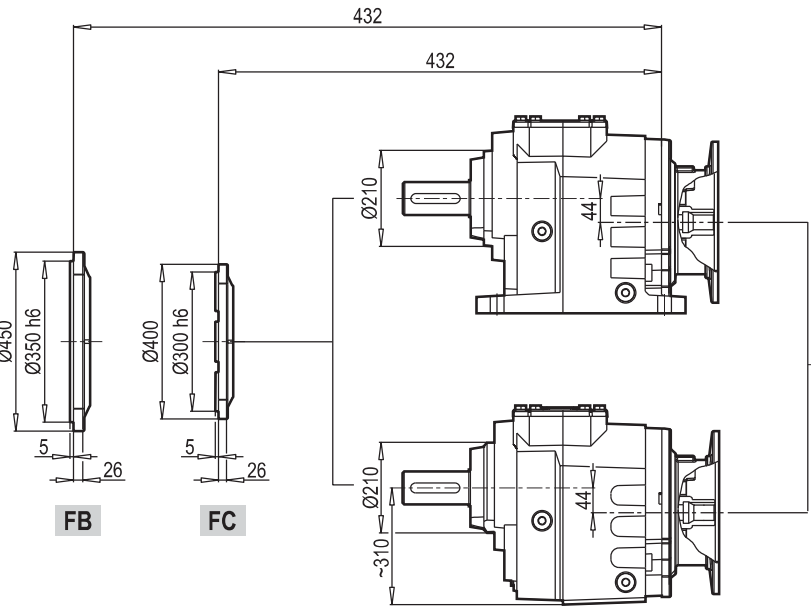

AF 902 - 903

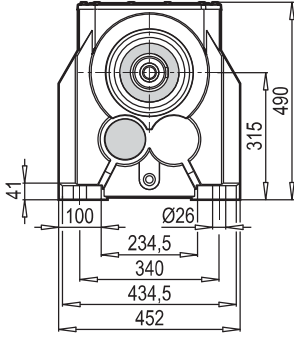
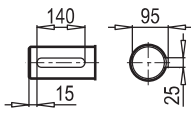
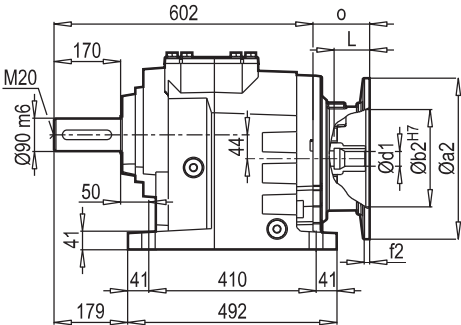
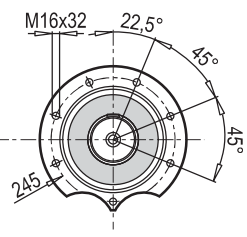

F 902 - 903

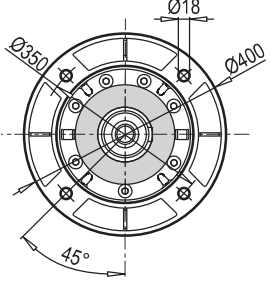
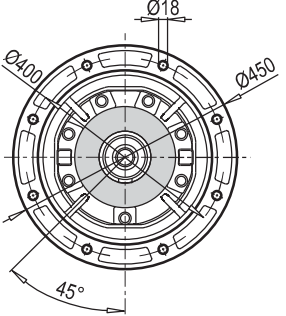
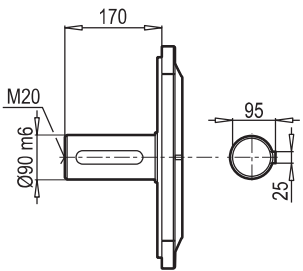

FB

FC

	132	160	180	200	225		
a2	300	350	350	400	450		
b2	230	250	250	300	350		
d1	38	42	48	55	60		
f2	5,5	7	7	7	7		
L	82	112	112	112	142		
u1	10	12	14	16	18		
t1	41,3	45,3	51,8	59,3	64,4		
o	76	124	124	161	161		