



Inverter

Inverter i510 Cabinet 0.25 ... 2.2 kW

Contents

About Lenze	4
The 5 phases.....	4
Portfolio overview	5
Inverter overview.....	6
About this document	8
Document description	8
Notations and conventions.....	9
Project planning	10
Procedure of an inverter configuration process.....	10
Dimensioning	10
Operation in motor and generator mode.....	13
Overcurrent operation.....	14
Safety instructions	15
Application as directed.....	15
Handling.....	16
Residual hazards.....	17
Control cabinet structure.....	18
Arrangement of components.....	18
Cables	19
Earthing concept.....	19
EMC-compliant installation	20
i510	22
Appendix	89
Good to know.....	89
Approvals/directives	89
Operating modes of the motor.....	90
Motor control types	91
Switching frequencies.....	93
Enclosures.....	93



About Lenze

The 5 phases

Lenze makes many things easy for you.

With our motivated and committed approach, we work together with you to create the best possible solution and set your ideas in motion - whether you are looking to optimise an existing machine or develop a new one. We always strive to make things easy and seek perfection therein. This is anchored in our thinking, in our services and in every detail of our products. It's as easy as that!

1 Developing ideas

Are you looking to build the best machine possible and already have some initial ideas? Then get these down on paper together with us, starting with small innovative details and stretching all the way to completely new machines. Working together, we will develop an intelligent and sustainable concept that is perfectly aligned with your specific requirements.

2 Drafting concepts

We see welcome challenges in your machine tasks, supporting you with our comprehensive expertise and providing valuable impetus for your innovations. We take a holistic view of the individual motion and control functions here and draw up consistent, end-to-end drive and automation solutions for you - keeping everything as easy as possible and as extensive as necessary.

3 Implementing solutions

Our easy formula for satisfied customers is to establish an active partnership with fast decision making processes and an individually tailored offer. We have been using this principle to meet the ever more specialised customer requirements in the field of machine engineering for many years.

4 Manufacturing machines

Functional diversity in perfect harmony: as one of the few full-range providers in the market, we can provide you with precisely those products that you actually need for any machine task — no more and no less. Our L-force product portfolio a consistent platform for implementing drive and automation tasks, is invaluable in this regard

5 Ensuring productivity



Productivity, reliability and new performance peaks on a daily basis these are our key success factors for your machine. After delivery, we offer you cleverly devised service concepts to ensure continued safe operation. The primary focus here is on technical support, based on the excellent application expertise of our highly-skilled and knowledgeable after-sales team.



Portfolio overview

Lenze products undergo the most stringent testing in our own laboratory. This allows us to ensure that you will receive consistently high quality and a long service life. In addition to this, five logistics centres ensure that the Lenze products you select are available for quick delivery anywhere across the globe.



As easy as that.

Controlling and visualising events	Automating and visualising machine modules	Automating and visualising machines
Logic Control	Machine module-Control	Machine Control
Visualisation		
Controllers		
Time and event-controlled motion	Speed and torque-controlled motion	Position-controlled single-axis and multi-axis motion
Mains operation	Inverter operation	Servo inverter operation
Inverters		
Motors		
Gearboxes		



Inverter overview

Comparison of i500

Inverter	i510			i550			
							
Application area	Pumps and fans, conveyor, travelling, winding, forming, tool and hoist drives						
Electrical supply system	1/N/PE AC 170 ... 264 V 45 ... 65 Hz	1/3/PE AC 170 ... 264 V 45 ... 65 Hz	3/PE AC 340 ... 528 V 45 ... 65 Hz	1/N/PE AC 170 ... 264 V 45 ... 65 Hz	1/3/PE AC 170 ... 264 V 45 ... 65 Hz	3/PE AC 170 ... 264 V 45 ... 65 Hz	3/PE AC 340 ... 528 V 45 ... 65 Hz
Motor power	0.25 ... 2.2 kW	0.25 ... 2.2 kW	0.37 ... 2.2 kW	0.25 ... 2.2 kW	0.25 ... 2.2 kW	4.0 ... 5.5 kW	0.37 ... 75 kW
Inverter output current	1.7 ... 9.6 A	1.7 ... 9.6 A	1.3 ... 5.6 A	1.7 ... 9.6 A	1.7 ... 9.6 A	16.5 ... 23 A	1.3 ... 150 A
Inverter efficiency class	IE2 according to EN 50598-2						
Max. inverter output current	150 % at an overload time of 60 s 200 % at an overload time of 3 s						
RFI filters	Integrated	not integrated	Integrated	Integrated	not integrated	Integrated	Integrated
Dissipation of regenerative energy	-	-	-	Brake resistor	Brake resistor	Brake resistor	Brake resistor DC-bus connection
Inverter version	Control cabinet						
Degree of protection	IP20 according to EN 60529						
Inverter mounting type	Installation, easy mounting via keyhole suspension						
Control connections and networks	Basic I/Os 5 digital inputs - 1 digital output 2 analog inputs - 1 analog output Modbus or CANopen (switchable)			Standard-I/O 5 digital inputs - 1 digital output 2 analog inputs - 1 analog output HTL incremental encoder via 2 digital inputs Modbus CANopen EtherCAT EtherNet/IP PROFIBUS PROFINET Application I/O 7 digital inputs - 2 digital outputs 2 analog inputs - 2 analog outputs HTL incremental encoder via 2 digital inputs			
More connections	Relay			Relay Connection for PTC or thermal contact External 24 V supply			
Functional safety	Without			STO (Safe torque off)			
Approvals	CE, RoHS2, UL (for USA and Canada), EAC						
Interference suppression	Residential areas C1, industrial premises C2						



Function	Inverter		Available as of firmware version		
	i510	i550	V1.1	V2.1	V3.0
Motor control					
V/f characteristic control linear/square-law (VFC plus)	•	•	•		
V/f characteristic control Midpoint	•	•			•
Sensorless vector control (SLVC)	•	•	•		
Energy saving function (VFCeco)	•	•		•	
Servo control for asynchronous motors		•		•	
Torque mode	•	•			•
Motor functions					
Flying restart circuit	•	•	•		
Slip compensation	•	•	•		
DC braking	•	•	•		
Oscillation damping	•	•	•		
Skip frequencies	•	•	•		
Automatic identification of the motor data	•	•		•	
Brake energy management	•	•	•		
Holding brake control	•	•		•	
Rotational Energy Ride Through (RERT)	•	•		•	
Speed feedback (HTL encoder)		•		•	
Application functions					
Process controller	•	•	•		
Parameter change-over	•	•	•		
S-shaped ramps for smooth acceleration	•	•	•		
Motor potentiometer	•	•	•		
Flexible I/O configuration	•	•	•		
Access protection	•	•	•		
Automatic restart	•	•	•		
Sequencer	•	•			•
Position counter		•			•
Monitoring					
Short circuit, earth fault	•	•	•		
Device overload monitoring ($I \times t$)	•	•	•		
Motor overload monitoring ($I^2 \times t$)	•	•	•		
Mains phase failure, motor phase failure	•	•	•		
Stalling protection	•	•	•		
Motor current limit	•	•	•		
Maximum torque	•	•	•		
Ultimate motor current	•	•	•		
Motor speed monitoring	•	•	•		
Load loss detection	•	•	•		
Motor temperature monitoring		•	•		
Diagnostics					
Error history buffer, logbook	•	•	•		
LED status display	•	•	•		
Network					
CANopen	•	•	•		
Modbus	•	•	•		
PROFIBUS		•	•		
EtherCAT		•		•	
EtherNet/IP		•		•	
PROFINET		•		•	
Functional safety (optional)					
STO (Safe torque off)		•	•		

About this document

Document description



About this document

Document description

This document is aimed at all persons who want to project inverters with the described products.

The data and information compiled here serve to support you in dimensioning and selecting and preparing the electrical and mechanical installation. You will receive information on product extensions and accessories.

More information

For certain tasks, more information is available in additional documents.

Document	Contents/topics
Commissioning document	Setting and parameterising the inverters
Mounting Instructions	Basic information for the mechanical and electrical installation <ul style="list-style-type: none">• Is supplied with each component.
"Functional safety" configuration document	Information on this (optional) function







Information and tools with regard to the Lenze products can be found on the Internet:
<http://www.lenze.com> → Download



Notations and conventions

This document uses the following conventions to distinguish different types of information:

Numbers			
	Decimal separator	Point	In general, the decimal point is used. Example: 1 234.56
Warning			
	UL warning	UL	Are used in English and French.
	UR warning	UR	
Text			
	Programs	» «	Software Example: »Engineer«, »EASY Starter«
Icons			
	Page reference		Reference to another page with additional information Example:  16 = see page 16
	Documentation reference		Reference to another documentation with additional information Example:  EDKxxx = see documentation EDKxxx

Layout of the safety instructions

DANGER!

This note refers to an imminent danger which, if not avoided, may result in death or serious injury.

WARNING!

This note refers to a danger which, if not avoided, may result in death or serious injury.

CAUTION!

This note refers to a danger which, if not avoided, may result in minor or moderate injury.

NOTICE

This note refers to a danger which, if not avoided, may result in damage to material assets.

Project planning

Procedure of an inverter configuration process
Dimensioning



Project planning

Procedure of an inverter configuration process

Dimensioning

3 methods for dimensioning

Fast: Selection of the inverter based on the motor data of a 4-pole asynchronous motor.

Detailed: In order to optimise the selection of the inverter and all drive components, it is worth to execute the detailed system dimensioning based on the physical requirements of the application. For this purpose, Lenze provides the «Drive Solution Designer» (DSD) design program.

Manual: The following chapter guides you step by step to the selection of a drive system.

Workflow of a configuration process

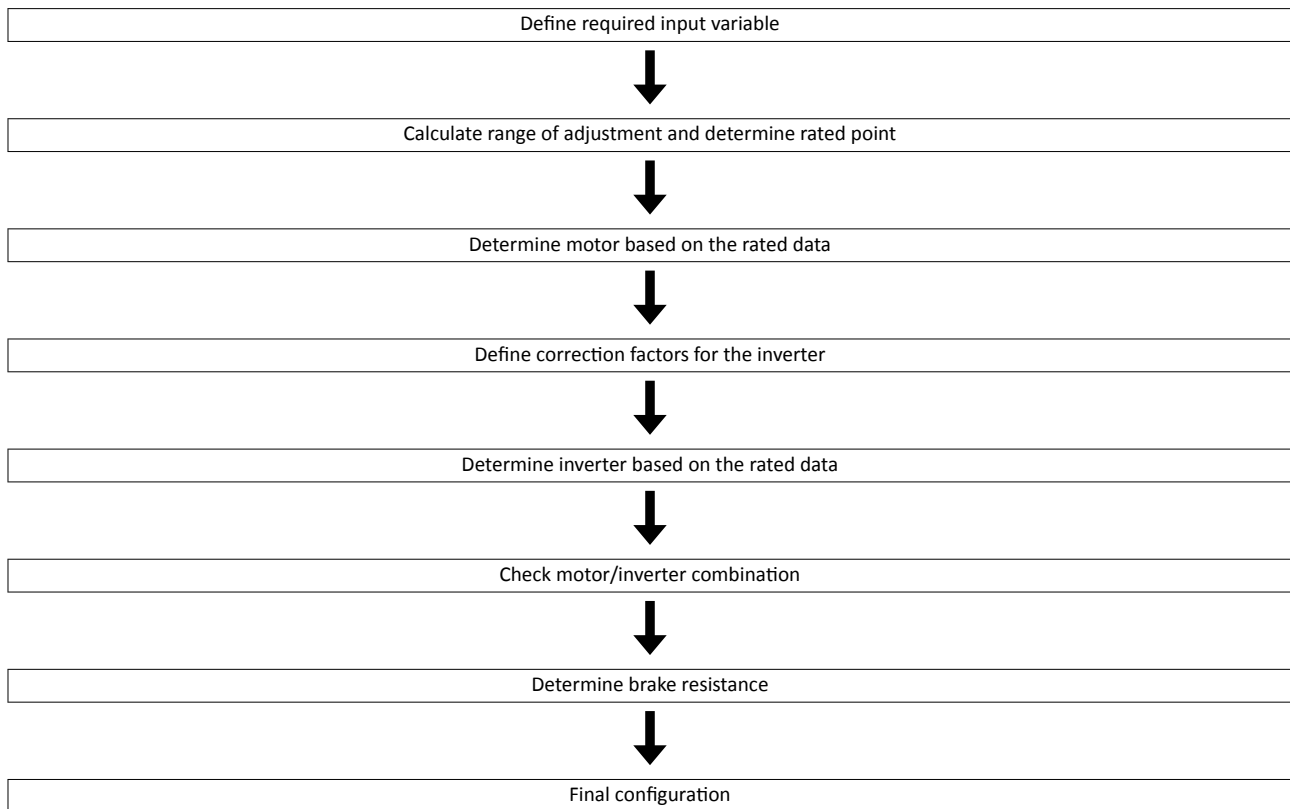

Define required input variables

Operating mode			S1 or S6
Max. load torque	$M_{L,max}$	Nm	
Max. load speed	$n_{L,max}$	rpm	
Min. load speed	$n_{L,min}$	rpm	
Site altitude	H	m	
Temperature in the control cabinet	T_U	°C	

Calculate range of adjustment and determine rated point

	Calculation
Setting range	$V = \frac{n_{L,max}}{n_{L,min}}$



	Setting range	Rated point
Motor with integral fan	≤ 2.50 (20 - 50 Hz)	50 Hz
	≤ 4.35 (20 - 87Hz)	87 Hz
	≤ 6 (20 - 120Hz)	120 Hz
Motor with blower	≤ 10.0 (5 - 50 Hz)	50 Hz
Motor with integral fan (reduced torque)	≤ 17.4 (5 - 87Hz)	87 Hz
	≤ 24 (5 - 120Hz)	120 Hz

Determine motor based on the rated data

			Check
Rated torque			
Operating mode S1	M_{rated}	Nm	$M_N \geq \frac{M_{L,max}}{T_{H,Mot} \times T_{U,Mot}}$
Operating mode S6	M_{rated}	Nm	$M_N \geq \frac{M_{L,max}}{2 \times T_{H,Mot} \times T_{U,Mot}}$
Rated speed	n_{rated}	rpm	$n_{rated} \geq n_{L,max}$ $\frac{n_n}{V} \leq n_{L,min}$

			Note
Rated torque	M_{rated}	Nm	→ Rated motor data
Rated speed	n_{rated}	rpm	
Rated point at		Hz	→ setting range
Power factor	cos φ		→ Rated motor data
Rated current	$I_{N,MOT}$	A	
Rated power	P_{rated}	kW	
Correction factor - site altitude	$T_{H,MOT}$		→ Technical motor data
Correction factor - ambient temperature	$T_{U,MOT}$		
Select motor			

Correction factors for the inverter

Site altitude Amsl	H				
	[m]	≤ 1000	≤ 2000	≤ 3000	≤ 4000
$k_{H,INV}$		1.00	0.95	0.90	0.85

Temperature in the control cabinet	T_U				
	[°C]	≤ 40	≤ 45	≤ 50	≤ 55
Switching frequency					
2 or 4 kHz	$k_{TU,INV}$	1.00	1.00	0.875	0.750
8 or 16 kHz		1.00	0.875	0.750	0.625

Determine inverter based on the rated data

			Check
Output current			
Continuous operation	I_{out}	A	$I_{out} \geq I_{N,Mot} / (k_{H,INV} \times k_{TU,INV})$
Overcurrent operation cycle 15 s	I_{out}	A	$I_{out} \geq I_{N,Mot} \times 2 / (k_{H,INV} \times k_{TU,INV})$
Overcurrent operation cycle 180 s	I_{out}	A	$I_{out} \geq I_{N,Mot} \times 1.5 / (k_{H,INV} \times k_{TU,INV})$

Check motor/inverter combination

			Calculation
Motor torque	M	Nm	$M = \sqrt{\left(\frac{I_{out,INV}}{I_{N,MOT}}\right)^2 - (1 - \cos\phi^2)} \times \frac{M_N}{\cos\phi}$

Project planning

Procedure of an inverter configuration process
Dimensioning



		Check
Overload capacity of the inverter		$\frac{M_{L,max}}{M} \leq 1.5$

Braking operation without additional measures

To decelerate small masses, the "DC injection brake DCB" function can be parameterised. DC-injection braking enables a quick deceleration of the drive to standstill without the need for an external brake resistor.

- A code can be used to select the braking current.
- The maximum braking torque to be realised by the DC braking current amounts to approx. 20 ... 30 % of the rated motor torque. It is lower compared to braking action in generator mode with external brake resistor.
- Automatic DC-injection braking (Auto-DCB) improves the starting performance of the motor when the operation mode without speed feedback is used.

Braking operation with external brake resistor

To decelerate greater moments of inertia or with a longer operation in generator mode an external brake resistor is required. It converts braking energy into heat.

The brake resistor is connected if the DC-bus voltage exceeds the switching threshold. überschreitet. This prevents the controller from setting pulse inhibit through the "Overvoltage" fault and the drive from coasting. The external brake resistor serves to control the braking process at any time.

The brake chopper integrated in the controller connects the external brake resistor.

Determine brake resistance

			Application	
			With active load	With passive load
Rated power	P_{rated}	kW	$P_N \geq P_{max} \times \eta_e \times \eta_m \times \frac{t_1}{t_2}$	$P_N \geq \frac{P_{max} \times \eta_e \times \eta_m}{2} \times \frac{t_1}{t_2}$
Thermal capacity	C_{th}	kWs	$C_{th} \geq P_{max} \times \eta_e \times \eta_m \times t_1$	$C_{th} \geq \frac{P_{max} \times \eta_e \times \eta_m}{2} \times t_1$
Rated resistance	R_{rated}	Ω	$R_N \geq \frac{U_{DC}^2}{P_{max} \times \eta_e \times \eta_m}$	

Active load	Can start to move independent of the drive (e.g. unwinder)
Passive load	Can stop independent of the drive (e.g. horizontal travelling drives, centrifuges, fans)
U_{DC} [V]	Switching threshold - brake chopper
P_{max} [W]	Maximum occurring braking power
η_e	Electrical efficiency
η_m	Mechanical efficiency
t_1 [s]	Braking time
t_2 [s]	Cycle time = time between two successive braking processes (t_1 + dead time)

Final configuration

Product extensions and accessories can be found here:

- [Product extensions](#) 55
- [Accessories](#) 62



Operation in motor and generator mode

The energy analysis differs between operation in motor mode and generator mode.

During operation in motor mode, the energy flows from the supplying mains via the inverter to the motor which converts electrical energy into mechanical energy (e. g. for lifting a load).

During operation in generator mode, the energy flows back from the motor to the inverter. The motor converts the mechanical energy into electrical energy - it acts as a generator (e. g. when lowering a load).

The drive brakes the load in a controlled manner.

The energy recovery causes a rise in the DC-bus voltage. If this voltage exceeds an upper limit, the output stage of the inverter will be blocked to prevent the device from being destroyed.

The drive coasts until the DC-bus voltage reaches the permissible value range again.

In order that the excessive energy can be dissipated, a brake resistor or a regenerative module is required.

Project planning

Procedure of an inverter configuration process
Overcurrent operation



Overcurrent operation

The inverters can be driven at higher amperages beyond the rated current if the duration of this overcurrent operation is time limited.

Two utilisation cycles of 15 s and 180 s are defined. Within these utilisation cycles, an overcurrent is possible for a certain time if afterwards an accordingly long recovery phase takes place.

Cycle 15 s

During this operation, the inverter may be loaded for 3 s with up to 200 % of the rated current if afterwards a recovery time of 12 s with max. 75 % of the rated current is observed. A cycle corresponds to 15 s.

Cycle 180 s

During this operation, the inverter may be loaded for 60 s with up to 150 % of the rated current if afterwards a recovery time of 120 s with max. 75 % of the rated current is observed. A cycle corresponds to 180 s.

The monitoring of the device utilisation (I_{xt}) causes the set error response if one of the two utilisation values exceeds the threshold of 100 %.



The maximum output currents correspond to the switching frequencies and the overload behaviour of the inverters are given in the rated data.

In case of rotating frequencies < 10 Hz, the time-related overload behaviour may be reduced.

The graphics shows a cycle. The basic conditions given in the table (graphics field highlighted in grey) have to be complied with in order that the inverter will not be overloaded. Both cycles can be combined with each other.

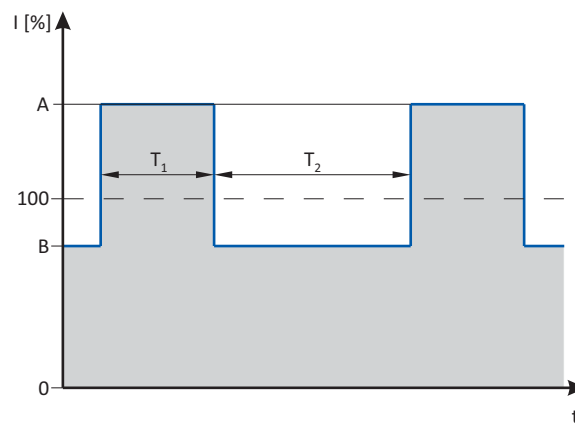

	Max. output current	Max. overload time	Max. output current during the recovery time	Min. recovery time
	A	T_1	B	T_2
	%	s	%	s
Cycle 15 s	200	3	75	12
Cycle 180 s	150	60	75	120



Safety instructions

Disregarding the following basic safety measures and safety information may lead to severe personal injury and damage to property!

Please observe the specific safety information in the other sections!

Application as directed

- The product must only be operated under the operating conditions prescribed in this documentation.
- The product meets the protection requirements of 2014/35/EU: Low-Voltage Directive.
- The product is not a machine in terms of 2006/42/EC: Machinery Directive.
- Commissioning or starting the operation as directed of a machine with the product is not permitted until it has been ensured that the machine meets the regulations of the EC Directive 2006/42/EC: Machinery Directive; observe EN 60204-1.
- Commissioning or starting the operation as directed is only allowed when there is compliance with the EMC Directive 2014/30/EU.
- The harmonised standard EN 61800-5-1 is used for the inverters.
- The product is not a household appliance, but is only designed as component for commercial or professional use in terms of EN 61000-3-2.
- The product can be used according to the technical data if drive systems have to comply with categories according to EN 61800-3.

In residential areas, the product may cause EMC interferences. The operator is responsible for taking interference suppression measures.

Project planning

Safety instructions
Handling



Handling

Transport, storage

Observe the notes regarding transport, storage and correct handling. Ensure proper handling and avoid mechanical stress. Do not bend any components and do not change any insulation distances during transport or handling. Do not touch any electronic components and contacts. Inverters contain electrostatically sensitive components which can easily be damaged by inappropriate handling. Do not damage or destroy any electrical components since thereby your health could be endangered!

Installation

The technical data and supply conditions can be obtained from the nameplate and the documentation. They must be strictly observed.

The inverters have to be installed and cooled according to the regulations given in the corresponding documentation. Observe the climatic conditions according to the technical data. The ambient air must not exceed the degree of pollution 2 according to EN 61800-5-1.

Electrical connection

When working on live inverters, observe the applicable national regulations for the prevention of accidents.

The electrical installation must be carried out according to the appropriate regulations (e. g. cable cross-sections, fuses, PE connection). Additional information can be obtained from the documentation.

This documentation contains information on installation in compliance with EMC (shielding, earthing, filter, and cables). These notes must also be observed for CE-marked inverters. The manufacturer of the system is responsible for compliance with the limit values demanded by EMC legislation. The inverters must be installed in housings (e. g. control cabinets) to meet the limit values for radio interferences valid at the site of installation. The housings must enable an EMC-compliant installation. Observe in particular that e. g. the control cabinet doors have a circumferential metal connection to the housing. Reduce housing openings and cutouts to a minimum.

Inverters may cause a DC current in the PE conductor. If a residual current device (RCD) is used for protection against direct or indirect contact for an inverter with three-phase supply, only a residual current device (RCD) of type B is permissible on the supply side of the inverter. If the inverter has a single-phase supply, a residual current device (RCD) of type A is also permissible. Apart from using a residual current device (RCD), other protective measures can be taken as well, e. g. electrical isolation by double or reinforced insulation or isolation from the supply system by means of a transformer.

Operation

If necessary, systems including inverters must be equipped with additional monitoring and protection devices according to the valid safety regulations.

After the inverter has been disconnected from the supply voltage, all live components and power terminals must not be touched immediately because capacitors can still be charged. Please observe the corresponding stickers on the inverter.

All protection covers and doors must be shut during operation.

You may adapt the inverters to your application by parameter setting within the limits available. For this, observe the notes in the documentation.

Safety functions

Certain inverter versions support safety functions (e. g. "safe torque off", formerly "safe standstill") according to the requirements of the EC Machinery Directive 2006/42/EC. The notes on the integrated safety provided in this documentation must be observed.

Maintenance and servicing

The inverters do not require any maintenance if the prescribed operating conditions are observed.



Disposal

In accordance with the current provisions, inverters and accessories have to be disposed of by means of professional recycling. Inverters contain recyclable raw material such as metal, plastics and electronic components.

Residual hazards

Even if notes given are taken into consideration and protective measures are implemented, the occurrence of residual risks cannot be fully prevented.

The user must take the residual hazards mentioned into consideration in the risk assessment for his/her machine/system.

If the above is disregarded, this can lead to severe injuries to persons and damage to property!

Protection of persons

Before working on the inverter, check if no voltage is applied to the power terminals.

- Depending on the device, the power terminals X105 remain live for up to 3 ... 20 minutes.
- The power terminals X100 and X105 remain live even when the motor is stopped.

Motor protection

With some settings of the inverter, the connected motor can be overheated.

- E. g. by longer operation of self-ventilated motors at low speed.
- E. g. by longer operation of the DC-injection brake.

Protection of the machine/system

Drives can reach dangerous overspeeds.

- E. g. by setting high output frequencies in connection with motors and machines not suitable for this purpose.
- The inverters do not provide protection against such operating conditions. For this purpose, use additional components.

Switch contactors in the motor cable only if the controller is inhibited.

- Switching while the inverter is enabled is only permissible if no monitoring functions are activated.

Motor

If there is a short circuit of two power transistors, a residual movement of up to 180° /number of pole pairs can occur at the motor! (For 4-pole motor: residual movement max. $180^\circ/2 = 90^\circ$).

Parameter set transfer

During the parameter set transfer, control terminals of the inverters can adopt undefined states.

- Thus, the control terminal of the digital input signals have to be removed before the transfer.
- This ensures that the inverter is inhibited. The control terminals are in a defined state.



Control cabinet structure

Control cabinet requirements

- Protection against electromagnetic interferences
- Compliance with the ambient conditions of the installed components

Mounting plate requirements

- The mounting plate must be electrically conductive.
 - Use zinc-coated mounting plates or mounting plates made of V2A.
 - Varnished mounting plates are unsuitable, even if the varnish is removed from the contact surfaces.
- When using several mounting plates, make a conductive connection over a large surface (e. g. using grounding strips).

Arrangement of components

- Division into power and control areas

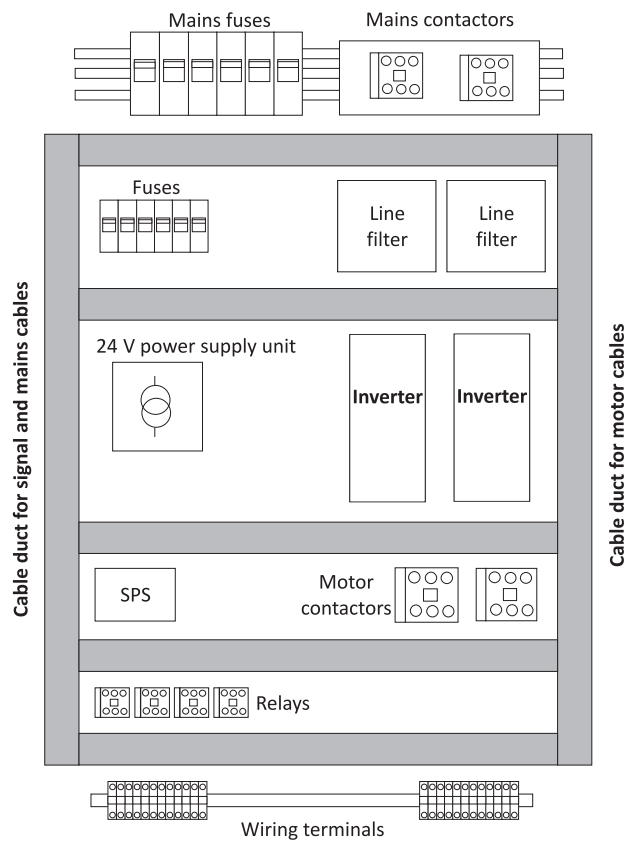

Fig. 1: Example for the ideal arrangement of components in the control cabinet



Cables

Requirements

- The cables used must correspond to the requirements at the location (e. g. EN 60204–1, UL).
- The cable cross-section must be dimensioned for the assigned fusing. Observe national and regional regulations.
- You must observe the regulations for minimum cross-sections of PE conductors. The cross-section of the PE conductor must be at least as large as the cross-section of the power connections.

Installation inside the control cabinet

- Always install cables close to the mounting plate (reference potential), as freely suspended cables act like aerials.
- Use separated cable channels for motor cables and control cables. Do not mix up different cable types in one cable channel.
- Lead the cables to the terminals in a straight line (avoid tangles of cables).
- Minimise coupling capacities and coupling inductances by avoiding unnecessary cable lengths and reserve loops.
- Short-circuit unused cores to the reference potential.
- Install the cables of a 24 V DC supply (positive and negative cable) close to each other or twisted over the entire length to avoid loops.

Installation outside the control cabinet

- In the case of greater cable lengths, a greater cable distance between the cables is required.
- In the case of parallel routing (cable trays) of cables with different types of signals, the degree of interference can be minimised by using a metallic cable separator or isolated cable ducts.

Earthing concept

- Set up the earthing system with a star topology.
- Connect all components (inverters, filters, chokes) to a central earthing point (PE rail).
- Comply with the corresponding minimum cross-sections of the cables.
- When using several mounting plates, make a conductive connection over a large surface (e. g. using grounding strips).

Project planning

Control cabinet structure
EMC-compliant installation



EMC-compliant installation

Structure of a CE-typical drive system

The drive system (frequency inverter and drive) corresponds to 2014/30/EU: EMC Directive if it is installed according to the specifications of the CE-typical drive system.

The structure in the control cabinet must support the EMC-compliant installation with shielded cables.

- Please use highly conductive shield connections.
- Connect the housing with shielding effect to the grounded mounting plate with a surface as large as possible, e. g. of inverters and RFI filters.
- Use central earthing points.

Matching accessories makes effective shielding easier.

- Shield sheets
- Shield clips/shield clamps
- Metallic cable ties

Mains connection, DC supply

- Inverters, mains chokes, or mains filters may only be connected to the mains via unshielded single cores or unshielded cables.
- When a line filter is used, shield the cable between mains filter or RFI filter and inverter if its length exceeds 300 mm. Unshielded cores must be twisted.
- In DC-bus operation or DC supply, use shielded cables.
 - Only certain inverters are provided with this connection facility.

Voltages for the DC-bus operation

Voltage on the motor side V_{AC}	DC supply V_{DC}	Voltage range V_{DC}	
400	565	480 - 0 % ... 622 + 0 %	2/PE
480	675	577 - 0 % ... 747 + 0 %	



Motor cable

- Only use low-capacitance and shielded motor cables with braid made of tinned or nickel-plated copper.
 - The overlap rate of the braid must be at least 70 % with an overlap angle of 90 °.
 - Shields made of steel braids are not suitable.
- Shield the cable for motor temperature monitoring (PTC or thermal contact) and install it separately from the motor cable.
 - In Lenze system cables, the cable for brake control is integrated into the motor cable. If this cable is not required for brake control, it can also be used to connect the motor temperature monitoring up to a length of 50 m.
 - Only certain inverters are provided with this connection facility.
- Connect the shield with a large surface and fix it with metal cable binders or conductive clamp. The following is suitable for the connection of the shield:
 - The mounting plate
 - A central grounding rail
 - A shield sheet, optional where necessary
- This is optimal:
 - The motor cable is separated from the mains cables and control cables.
 - The motor cable only crosses mains cables and control cables at right angles.
 - The motor cable is not interrupted.
- If the motor cable must be opened all the same (e. g. by chokes, contactors, or terminals):
 - The unshielded cable ends must not be longer than 100 mm (depending on the cable cross-section).
 - Install chokes, contactors, terminals etc. spatially separated from other components (with a minimum distance of 100 mm).
 - Install the shield of the motor cable directly before and behind the point of separation to the mounting plate with a large surface.
- Connect the shield with a large surface to PE in the terminal box of the motor at the motor housing.
 - Metal EMC cable glands at the motor terminal box ensure a large surface connection of the shield with the motor housing.

Control cables

- Install the cables so that no induction-sensitive loops arise.
- Distance of shield connections of control cables to shield connections of motor cables and DC cables:
 - At least 50 mm
- Control cables for analog signals:
 - Must always be shielded
 - Connect the shield on one side of the inverter
- Control cables for digital signals:

	Cable length		
	< ca. 5 m	ca. 5 m ... ca. 30 m	> ca. 30 m
Design	unshielded option	unshielded twisted option	always shielded connected on both sides

Network cables

- Cables and wiring must comply with the specifications and requirements of the used network.
 - Ensures the reliable operation of the network in typical systems.



Inverter

Inverter i510 Cabinet 0.25 ... 2.2 kW

Inhalt

Product information	25
Product description	25
Equipment	26
The modular system	27
The concept	27
Topologies / network	27
Ways of commissioning	28
Functions	29
Overview	29
Motor control types	29
Features	30
Motor setting range	30
The name of the product	32
Technical data	33
Standards and operating conditions	33
Conformities/approvals	33
Protection of persons and device protection	33
EMC data	33
Motor connection	34
Environmental conditions	34
Electrical supply conditions	34
1-phase mains connection 230/240 V	35
Rated data	35
Fusing and terminal data	37
1/3-phase mains connection 230/240 V	39
Rated data	40
Fusing and terminal data	42
3-phase mains connection 400 V	44
Rated data	44
Fusing and terminal data	46
3-phase mains connection 480 V	48
Rated data	48
Fusing and terminal data	50
Dimensions	52
0.25 kW ... 0.37 kW	52
0.55 kW ... 0.75 kW	53
1.1 kW ... 2.2 kW	54

Inhalt

Product extensions	55
Overview.....	55
I/O extensions.....	56
Basic I/Os.....	56
Data of control connections.....	57
More control connections.....	59
Relay output.....	59
Networks.....	60
CANopen/Modbus.....	60
CANopen.....	61
Modbus.....	61
Accessories	62
Overview.....	62
Operation and diagnostics.....	63
Keypad.....	63
USB module.....	63
WLAN module.....	64
Blanking cover.....	65
Setpoint potentiometer.....	66
Memory modules.....	66
Memory module copier.....	66
Mains chokes.....	67
1-phase mains connection 230/240 V.....	67
1/3-phase mains connection 230/240 V.....	67
3-phase mains connection 400 V.....	68
3-phase mains connection 480 V.....	68
RFI filters / Mains filters.....	69
Sine filter.....	73
Brake switches.....	73
Mounting.....	74
Shield mounting kit.....	74
Terminal strips.....	75
Mounting/ installation	76
Electrical installation.....	78
Important notes.....	78
Mains connection.....	81
1-phase mains connection 230/240 V.....	82
1/3-phase mains connection 230/240 V.....	83
3-phase mains connection 400 V.....	84
3-phase mains connection 480 V.....	85
Motor connection.....	86
Switching in the motor cable.....	86
Control connections.....	86
Purchase order	87
Notes on ordering.....	87
Order code.....	88



Product information

Product description

i500 is the new inverter series - a streamlined design, scalable functionality and exceptional user-friendliness.

i500 is a high-quality inverter that already conforms to future standard in accordance with the EN 50598-2 efficiency classes (IE). Overall, this provides a reliable and future-proof drive for a wide range of machine applications.



The i510

This chapter provides the complete scope of the inverter i510. This version is suitable for simple applications in inverter-operated drives. Basically, the device has the following features:

- All typical motor control types of modern inverters.
- Stroke and continuous operation of the motor according to common operating modes.
- Networking options via CANopen/Modbus.
- Extensively integrated functions.

Highlights

- Compact size
 - Only 60 mm wide and 130 mm deep
- Can be directly connected without external cooling
- Innovative interaction options enable better set-up times than ever.

Application ranges

- Pumps and fans
- Conveying and travelling drives
- Forming and tool drives

Product information

Equipment



Equipment

Earth / ground connection (PE)

Mains voltage connection X100

Relay output X9

IT screw

from 0.55 kW

Network X2xx

CANopen/Modbus (Option)

Memory module X20

Network status-LEDs

Inverter status LEDs

Shield connection

CANopen/Modbus

Toggle switch

CANopen/Modbus

Interface X16

Diagnostic module

Shield connection

Control connections

Control terminals X3

Basic I/O

IT screw

Motor connection X105

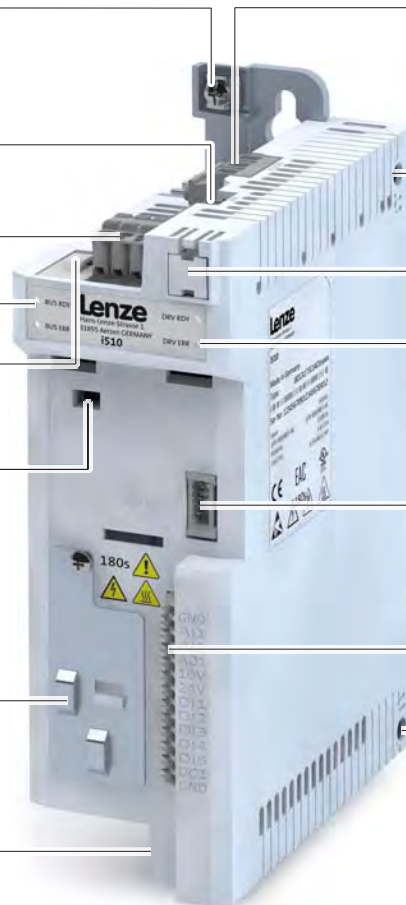

Terminal designations X... see connection plans

Position and meaning of the nameplates

Complete inverter



①	Technical data
②	Type and serial number of the inverter



The modular system

The concept

The inverter i510 is a compact device unit consisting of control unit and power unit.

The i510 is always delivered as a complete inverter.



2 versions are available:

- Without network.
- With CANopen/Modbus, switchable.

Kompletter Inverter



Topologies / network

	<p>CANopen® is a communication protocol based on CAN. CANopen® is a registered community trademark of the CAN user organisation CiA® (CAN in Automation e. V.). The EDS device description files for CANopen can be found here: http://www.lenze.com/application-knowledge-base/artikel/200413930/0/</p>
	<p>The Modbus protocol is an open communication protocol based on a client/server architecture and developed for the communication with programmable logic controllers. The further development is carried out by the international user organisation Modbus Organization, USA.</p>

More information on the supported networks can be found at <http://www.lenze.com>

Product information

The modular system
Ways of commissioning



Ways of commissioning

- Keypad

If it's only a matter of setting a few key parameters such as acceleration and deceleration time, this can be done quickly on the keypad.



- Smart-Keypad-App for Android

The intuitive smartphone app enables adjustment to a simple application such as a conveyor belt.

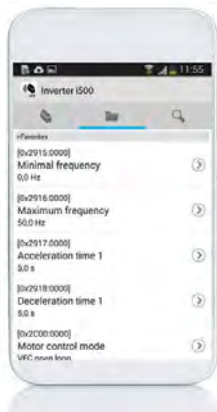

- »EASY Starter«

If functions such as the holding brake control or sequencer need to be set, it's best to use the »EASY Starter« engineering tool.





Functions

Overview

The inverters i510 are adjusted to simple applications regarding their functionality.

Functions	
Motor control	Monitoring
V/f characteristic control linear/square-law (VFC plus)	Short circuit
Sensorless vector control (SLVC)	earth fault
Energy saving function (VFCeco)	Device overload monitoring (i^*t)
Torque mode	Motor overload monitoring (i^2*t)
	Mains phase failure
	Stalling protection
	Motor current limit
	Maximum torque
	Ultimate motor current
	Motor speed monitoring
	Load loss detection
Motor functions	Diagnostics
Flying restart circuit	Error history buffer
Slip compensation	Logbook
DC braking	LED status display
Oscillation damping	Keypad language selection German, English
Skip frequencies	
Automatic identification of the motor data	
Brake energy management	
Holding brake control	
Voltage add – function	
Rotational Energy Ride Through (RERT)	
Application functions	Network
Process controller	CANopen
Process controller - idle state and rinse function	Modbus
Freely assignable favourite menu	
Parameter change-over	
S-shaped ramps for smooth acceleration	
Motor potentiometer	
Flexible I/O configuration	
Access protection	
Automatic restart	
OEM parameter set	
Sequencer	

Motor control types

The following table contains the possible control types with Lenze motors.

Motors	V/f characteristic control VFCplus	Sensorless vector control SLVC	ASM servo control SC ASM
Three-phase AC motors			
MD	•	•	
MF	•	•	
mH	•	•	
m500	•	•	

Product information

Features
Motor setting range



Features

Motor setting range

Rated point 120 Hz



Only possible with Lenze MF motors.

The rated motor torque is available up to 120 Hz.

Compared to the 50-Hz operation, the setting range increases by 2.5 times.

It is quite simply not possible for a drive to be operated any more efficiently in a machine.

V/f at 120 Hz

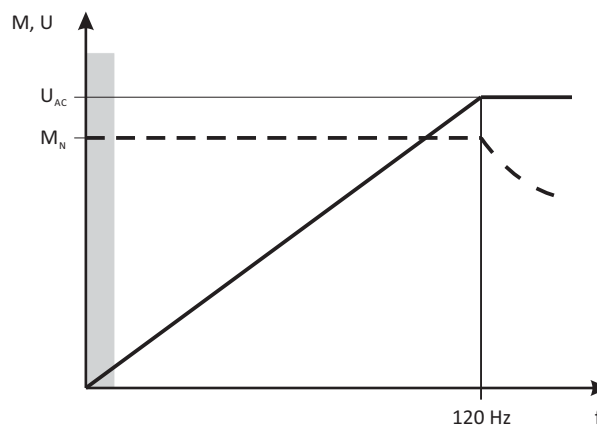

V Voltage
M Torque
f Frequency

U_{AC} Mains voltage
 M_{rated} Rated torque

Rated point 87 Hz

The rated motor torque is available up to 87 Hz.

Compared to the 50-Hz operation, the setting range increases by 1.74 times.

For this purpose, a motor with 230/400 V in star connection is driven by a 400-V inverter.

The inverter must be dimensioned for a rated motor current of 230 V.

V/f at 87 Hz

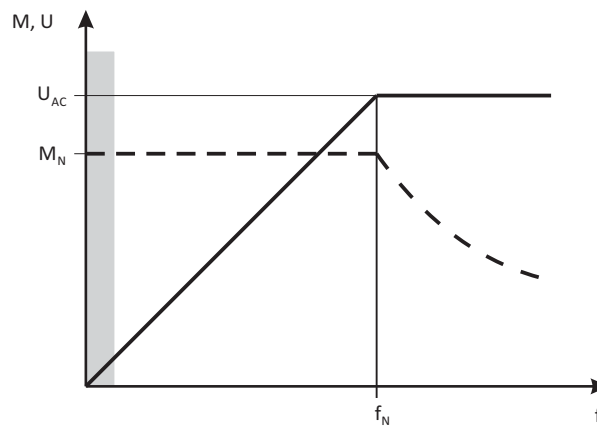



V Voltage
M Torque
f Frequency

U_{AC} Mains voltage
 M_{rated} Rated torque
 f_{rated} Rated frequency

Rated point 50 Hz

The rated motor torque is available up to 50 Hz.

V/f at 50 Hz

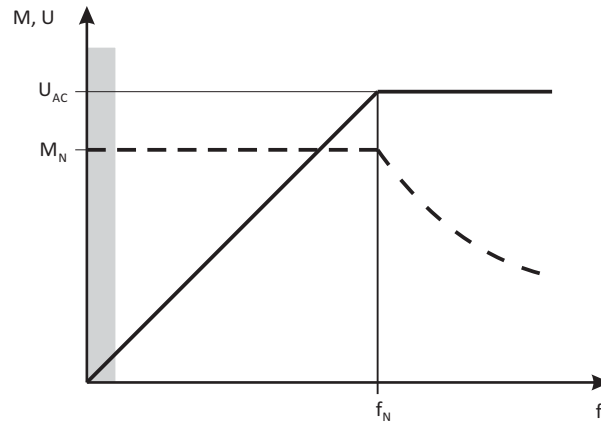

V Voltage
M Torque
f Frequency

U_{AC} Mains voltage
 M_{rated} Rated torque
 f_{rated} Rated frequency

Product information

The name of the product



The name of the product

When the technical data of the different versions were listed, the product name was entered because it is easier to read than the individual type code of the product. The product name is also used for the accessories. The assignment of product name and order code can be found in the Order chapter.

The product name contains the power in kW, mains voltage class 230 V/ 400 V and the number of phases.

The 1/3-phase inverters are marked at the end with "-2".

"C" marks the "Cabinet" version = inverter for the installation into the control cabinet.

Inverter series	Design	Rated power	Rated mains voltage	Number of phases	Inverter product name
		kW	V		
i510	C	0.25	230	1	i510-C0.25/230-1
		0.37			i510-C0.37/230-1
		0.55			i510-C0.55/230-1
		0.75			i510-C0.75/230-1
		1.1			i510-C1.1/230-1
		1.5			i510-C1.5/230-1
		2.2			i510-C2.2/230-1
		0.25	230/240	1/3	i510-C0.25/230-2
		0.37			i510-C0.37/230-2
		0.55			i510-C0.55/230-2
		0.75			i510-C0.75/230-2
		1.1			i510-C1.1/230-2
		1.5			i510-C1.5/230-2
		2.2			i510-C2.2/230-2
		0.37	400/480	3	i510-C0.37/400-3
		0.55			i510-C0.55/400-3
		0.75			i510-C0.75/400-3
		1.1			i510-C1.1/400-3
1.5	i510-C1.5/400-3				
2.2	i510-C2.2/400-3				



Technical data

Standards and operating conditions

Conformities/approvals

Conformities		
CE	2014/35/EU	Low-Voltage Directive
	2014/30/EU	EMC Directive (reference: CE-typical drive system)
EAC	TR TC 004/2011	Eurasian conformity: safety of low voltage equipment
	TP TC 020/2011	Eurasian conformity: electromagnetic compatibility of technical means
RoHS 2	2011/65/EU	Restrictions for the use of specific hazardous materials in electric and electronic devices
Approvals		
UL	UL 61800-5-1	for USA and Canada (requirements of the CSA 22.2 No. 274)

Protection of persons and device protection

Degree of protection		
IP20	EN 60529	
Type 1	NEMA 250	Protection against contact
Open type		only in UL-approved systems
Insulation resistance		
Overvoltage category III	EN 61800-5-1	0 ... 2000 m a.m.s.l.
Overvoltage category II		above 2000 m a.m.s.l.
Control circuit isolation		
Safe mains isolation by double/reinforced insulation	EN 61800-5-1	
Protective measures against		
Short circuit		Earth fault strength depends on the operating status
earth fault		
overvoltage		
Motor stalling		I ² xt monitoring
Motor overtemperature		
Leakage current		
> 3.5 mA AC, > 10 mA DC	EN 61800-5-1	Observe regulations and safety instructions!
Cyclic mains switching		
3 times per minute		Without restrictions
Starting current		
≤ 3 x rated mains current		

EMC data

Actuation on public supply systems		
Implement measures to limit the radio interference to be expected:		The machine or plant manufacturer is responsible for compliance with the requirements for the machine/plant!
< 1 kW: with mains choke	EN 61000-3-2	
> 1 kW at mains current ≤ 16 A: without additional measures		
Mains current > 16 A: with mains choke or mains filter, with dimensioning for rated power. R _{sce} ≥ 120 is to be met.	EN 61000-3-12	RSCE: short-circuit power ratio at the connection point of the machine/plant to the public network.
Noise emission		
Category C2	EN 61800-3	Type-dependent, for motor cable lengths see rated data
Noise immunity		
Meets requirement in compliance with	EN 61800-3	

Technical data

Standards and operating conditions
Motor connection



Motor connection

Requirements to the shielded motor cable		
Capacitance per unit length		
C-core-core/C-core-shield < 75/150 pF/m		≤ 2.5 mm ² / AWG 14
C-core-core/C-core-shield < 150/300 pF/m		≥ 4 mm ² / AWG 12
Electric strength		
U ₀ /U = 0.6/1.0 kV		U = r.m.s. value external conductor/external conductor
		U ₀ = r.m.s. value external conductor to PE
U ≥ 600 V	UL	U = r.m.s. value external conductor/external conductor

Environmental conditions

Energy efficiency		
Class IE2	EN 50598-2	Reference: Lenze setting (switching frequency 8 kHz variable)
Climate		
1K3 (-25 ... +60 °C)	EN 60721-3-1	Storage
2K3 (-25 ... +70 °C)	EN 60721-3-2	Transport
3K3 (-10 ... +55 °C)	EN 60721-3-3	operation
		Operation at a switching frequency of 2 or 4 kHz: above +45°C, reduce rated output current by 2.5 %/°C
		Operation at a switching frequency of 8 or 16 kHz: above +40°C, reduce rated output current by 2.5 %/°C
Site altitude		
0 ... 1000 m a.m.s.l.		
1000 ... 4000 m a.m.s.l.		Reduce rated output current by 5 %/1000 m
Pollution		
Degree of pollution 2	EN 61800-5-1	
Vibration resistance		
Transport		
2M2 (sine, shock)	EN 60721-3-2	
operation		
Amplitude 1 mm	Germanischer Lloyd	5 ... 13.2 Hz
Acceleration resistant up to 0.7 g		13.2 ... 100 Hz
Amplitude 0.075 mm	EN 61800-5-1	10 ... 57 Hz
Acceleration resistant up to 1 g		57 ... 150 Hz

Electrical supply conditions

The connection to different supply forms enables a worldwide application of the inverters.

The following is supported:

- [1-phase mains connection 230/240 V](#) 35
- [1/3-phase mains connection 230/240 V](#) 39
- [3-phase mains connection 400 V](#) 44
- [3-phase mains connection 480 V](#) 48

Permissible mains systems		
TT		Voltage to earth/ground: max. 300 V
TN		
IT		
		Apply the measures described for IT systems!
		IT systems are not relevant for UL-approved systems



1-phase mains connection 230/240 V

Rated data

The output currents apply to these operating conditions:

- At a switching frequency of 2 kHz or 4 kHz: Max. ambient temperature 45°C.
- At a switching frequency of 8 kHz or 16 kHz: Max. ambient temperature 40 °C.

Inverter		i510-C0.25/230-1	i510-C0.37/230-1	i510-C0.55/230-1	i510-C0.75/230-1
Rated power	kW	0.25	0.37	0.55	0.75
Mains voltage range		1/N/PE AC 170 V ... 264 V, 45 Hz ... 65 Hz			
Rated mains current					
without mains choke	A	4	5.7	7.6	10
with mains choke	A	3.6	4.8	7.1	8.8
Apparent output power	kVA	0.6	0.9	1.2	1.6
Output current					
2 kHz	A	-	-	3.2	4.2
4 kHz	A	1.7	2.4	3.2	4.2
8 kHz	A	1.7	2.4	3.2	4.2
16 kHz	A	1.1	1.6	2.1	2.8
Power loss					
4 kHz	W	15	18	23	29
8 kHz	W	15	20	25	33
at controller inhibit	W	6	6	6	6
Overcurrent cycle 180 s					
Max. output current	A	2.6	3.6	4.8	6.3
Overload time	s	60	60	60	60
Recovery time	s	120	120	120	120
Max. output current during the recovery time	A	1.3	1.8	2.4	3.2
Overcurrent cycle 15 s					
Max. output current	A	3.4	4.8	6.4	8.4
Overload time	s	3	3	3	3
Recovery time	s	12	12	12	12
Max. output current during the recovery time	A	1.3	1.8	2.4	3.2
Max. motor cable length shielded					
without EMC category	m	50			
Category C2	m	15		20	
Weight	kg	0.75		0.95	

Technical data

1-phase mains connection 230/240 V

Rated data



Inverter		i510-C1.1/230-1	i510-C1.5/230-1	i510-C2.2/230-1
Rated power	kW	1.1	1.5	2.2
Mains voltage range		1/N/PE AC 170 V ... 264 V, 45 Hz ... 65 Hz		
Rated mains current				
without mains choke	A	14.3	16.7	22.5
with mains choke	A	11.9	13.9	16.9
Apparent output power	kVA	2.2	2.6	3.6
Output current				
2 kHz	A	6	7	9.6
4 kHz	A	6	7	9.6
8 kHz	A	6	7	9.6
16 kHz	A	4	4.7	6.4
Power loss				
4 kHz	W	37	43	60
8 kHz	W	42	50	70
at controller inhibit	W	6	6	6
Overcurrent cycle 180 s				
Max. output current	A	9	10.5	14.4
Overload time	s	60	60	60
Recovery time	s	120	120	120
Max. output current during the recovery time	A	4.5	5.3	7.2
Overcurrent cycle 15 s				
Max. output current	A	12	14	19.2
Overload time	s	3	3	3
Recovery time	s	12	12	12
Max. output current during the recovery time	A	4.5	5.3	7.2
Max. motor cable length shielded				
without EMC category	m	50		
Category C2	m	20		
Weight	kg	1.35		



Technical data

1-phase mains connection 230/240 V
Fusing and terminal data

Fusing and terminal data

Inverter		i510-C0.25/230-1	i510-C0.37/230-1	i510-C0.55/230-1	i510-C0.75/230-1
Cable installation in compliance with		EN 60204-1			
Laying system		B2			
operation		without mains choke			
Fuse					
Characteristics		gG/gL or gRL			
Max. rated current	A	10	10	16	16
Circuit breaker					
Characteristics		B			
Max. rated current	A	10	10	16	16
operation		with mains choke			
Fuse					
Characteristics		gG/gL or gRL			
Max. rated current	A	10	10	16	16
Circuit breaker					
Characteristics		B			
Max. rated current	A	10	10	16	16
Earth-leakage circuit breaker					
1-phase mains connection		≥ 30 mA, type A or B			
Mains connection					
Connection		X100			
Connection type		pluggable screw terminal			
Min. cable cross-section	mm ²	1			
Max. cable cross-section	mm ²	2.5			
Stripping length	mm	8			
Tightening torque	Nm	0.5			
Required tool		0.5 x 3.0			
Motor connection					
Connection		X105			
Connection type		pluggable screw terminal			
Min. cable cross-section	mm ²	1			
Max. cable cross-section	mm ²	2.5			
Stripping length	mm	8			
Tightening torque	Nm	0.5			
Required tool		0.5 x 3.0			

Technical data

1-phase mains connection 230/240 V
Fusing and terminal data



Inverter		i510-C1.1/230-1	i510-C1.5/230-1	i510-C2.2/230-1
Cable installation in compliance with		EN 60204-1		
Laying system		B2		
operation		without mains choke		
Fuse		gG/gL or gRL		
Characteristics		gG/gL or gRL		
Max. rated current	A	25	25	25
Circuit breaker		B		
Characteristics		B		
Max. rated current	A	25	25	25
operation		with mains choke		
Fuse		gG/gL or gRL		
Characteristics		gG/gL or gRL		
Max. rated current	A	25	25	25
Circuit breaker		B		
Characteristics		B		
Max. rated current	A	25	25	25
Earth-leakage circuit breaker		≥ 30 mA, type A or B		
1-phase mains connection		≥ 30 mA, type A or B		
Mains connection		X100		
Connection		X100		
Connection type		pluggable screw terminal		
Min. cable cross-section	mm ²	1		
Max. cable cross-section	mm ²	6		
Stripping length	mm	8		
Tightening torque	Nm	0.7		
Required tool		0.6 x 3.5		
Motor connection		X105		
Connection		X105		
Connection type		pluggable screw terminal		
Min. cable cross-section	mm ²	1		
Max. cable cross-section	mm ²	2.5		
Stripping length	mm	8		
Tightening torque	Nm	0.5		
Required tool		0.5 x 3.0		



Technical data

1/3-phase mains connection 230/240 V
Fusing and terminal data

1/3-phase mains connection 230/240 V



EMC filters are **not integrated** in inverters for this mains connection.

Technical data

1/3-phase mains connection 230/240 V

Rated data



Rated data

The output currents apply to these operating conditions:

- At a switching frequency of 2 kHz or 4 kHz: Max. ambient temperature 45°C.
- At a switching frequency of 8 kHz or 16 kHz: Max. ambient temperature 40 °C.

Inverter		i510-C0.25/230-2	i510-C0.37/230-2	i510-C0.55/230-2	i510-C0.75/230-2
Rated power	kW	0.25	0.37	0.55	0.75
Mains voltage range		1/N/PE AC 170 V ... 264 V, 45 Hz ... 65 Hz			
Rated mains current					
without mains choke	A	4	5.7	7.6	10
with mains choke	A	3.6	4.8	7.1	8.8
Mains voltage range		3/PE AC 170 V ... 264 V, 45 Hz ... 65 Hz			
Rated mains current					
without mains choke	A	2.6	3.9	4.8	6.4
with mains choke	A	2	3	3.8	5.1
Apparent output power	kVA	0.6	0.9	1.2	1.6
Output current					
2 kHz	A	-	-	3.2	4.2
4 kHz	A	1.7	2.4	3.2	4.2
8 kHz	A	1.7	2.4	3.2	4.2
16 kHz	A	1.1	1.6	2.1	2.8
Power loss					
4 kHz	W	15	18	23	29
8 kHz	W	15	20	25	33
at controller inhibit	W	6	6	6	6
Overcurrent cycle 180 s					
Max. output current	A	2.6	3.6	4.8	6.3
Overload time	s	60	60	60	60
Recovery time	s	120	120	120	120
Max. output current during the recovery time	A	1.3	1.8	2.4	3.2
Overcurrent cycle 15 s					
Max. output current	A	3.4	4.8	6.4	8.4
Overload time	s	3	3	3	3
Recovery time	s	12	12	12	12
Max. output current during the recovery time	A	1.3	1.8	2.4	3.2
Max. motor cable length shielded					
without EMC category	m	50			
Weight	kg	0.75		0.95	



Technical data

1/3-phase mains connection 230/240 V
Rated data

Inverter		i510-C1.1/230-2	i510-C1.5/230-2	i510-C2.2/230-2
Rated power	kW	1.1	1.5	2.2
Mains voltage range		1/N/PE AC 170 V ... 264 V, 45 Hz ... 65 Hz		
Rated mains current				
without mains choke	A	14.3	16.7	22.5
with mains choke	A	11.9	13.9	16.9
Mains voltage range		3/PE AC 170 V ... 264 V, 45 Hz ... 65 Hz		
Rated mains current				
without mains choke	A	7.8	9.5	13.6
with mains choke	A	5.6	6.8	9.8
Apparent output power	kVA	2.2	2.6	3.6
Output current				
2 kHz	A	6	7	9.6
4 kHz	A	6	7	9.6
8 kHz	A	6	7	9.6
16 kHz	A	4	4.7	6.4
Power loss				
4 kHz	W	37	43	60
8 kHz	W	42	50	70
at controller inhibit	W	6	6	6
Overcurrent cycle 180 s				
Max. output current	A	9	10.5	14.4
Overload time	s	60	60	60
Recovery time	s	120	120	120
Max. output current during the recovery time	A	4.5	5.3	7.2
Overcurrent cycle 15 s				
Max. output current	A	12	14	19.2
Overload time	s	3	3	3
Recovery time	s	12	12	12
Max. output current during the recovery time	A	4.5	5.3	7.2
Max. motor cable length shielded				
without EMC category	m	50		
Weight	kg	1.35		

Technical data

1/3-phase mains connection 230/240 V
Fusing and terminal data



Fusing and terminal data

Inverter		i510-C0.25/230-2	i510-C0.37/230-2	i510-C0.55/230-2	i510-C0.75/230-2
Cable installation in compliance with		EN 60204-1			
Laying system		B2			
operation		without mains choke			
Fuse					
Characteristics		gG/gL or gRL			
Max. rated current	A	10	10	16	16
Circuit breaker					
Characteristics		B			
Max. rated current	A	10	10	16	16
operation		with mains choke			
Fuse					
Characteristics		gG/gL or gRL			
Max. rated current	A	10	10	16	16
Circuit breaker					
Characteristics		B			
Max. rated current	A	10	10	16	16
Earth-leakage circuit breaker					
1-phase mains connection		≥ 30 mA, type A or B			
3-phase mains connection		≥ 30 mA, type B			
Mains connection					
Connection		X100			
Connection type		pluggable screw terminal			
Min. cable cross-section	mm ²	1			
Max. cable cross-section	mm ²	2.5			
Stripping length	mm	8			
Tightening torque	Nm	0.5			
Required tool		0.5 x 3.0			
Motor connection					
Connection		X105			
Connection type		pluggable screw terminal			
Min. cable cross-section	mm ²	1			
Max. cable cross-section	mm ²	2.5			
Stripping length	mm	8			
Tightening torque	Nm	0.5			
Required tool		0.5 x 3.0			



Technical data

1/3-phase mains connection 230/240 V
Fusing and terminal data

Inverter		i510-C1.1/230-2	i510-C1.5/230-2	i510-C2.2/230-2
Cable installation in compliance with		EN 60204-1		
Laying system		B2		
operation		without mains choke		
Fuse		gG/gL or gRL		
Characteristics		gG/gL or gRL		
Max. rated current	A	25	25	25
Circuit breaker		B		
Characteristics		B		
Max. rated current	A	25	25	25
operation		with mains choke		
Fuse		gG/gL or gRL		
Characteristics		gG/gL or gRL		
Max. rated current	A	25	25	25
Circuit breaker		B		
Characteristics		B		
Max. rated current	A	25	25	25
Earth-leakage circuit breaker		≥ 30 mA, type A or B		
1-phase mains connection		≥ 30 mA, type A or B		
3-phase mains connection		≥ 30 mA, type B		
Mains connection		X100		
Connection		X100		
Connection type		pluggable screw terminal		
Min. cable cross-section	mm ²	1		
Max. cable cross-section	mm ²	6		
Stripping length	mm	8		
Tightening torque	Nm	0.7		
Required tool		0.6 x 3.5		
Motor connection		X105		
Connection		X105		
Connection type		pluggable screw terminal		
Min. cable cross-section	mm ²	1		
Max. cable cross-section	mm ²	2.5		
Stripping length	mm	8		
Tightening torque	Nm	0.5		
Required tool		0.5 x 3.0		

Technical data

3-phase mains connection 400 V
Rated data



3-phase mains connection 400 V

Rated data

The output currents apply to these operating conditions:

- At a switching frequency of 2 kHz or 4 kHz: Max. ambient temperature 45°C.
- At a switching frequency of 8 kHz or 16 kHz: Max. ambient temperature 40 °C.

Inverter		i510-C0.37/400-3	i510-C0.55/400-3	i510-C0.75/400-3	i510-C1.1/400-3
Rated power	kW	0.37	0.55	0.75	1.1
Mains voltage range		3/PE AC 340 V ... 528 V, 45 Hz ... 65 Hz			
Rated mains current					
without mains choke	A	1.8	2.5	3.3	4.4
with mains choke	A	1.4	2	2.6	3
Apparent output power	kVA	0.9	1.2	1.6	2.2
Output current					
2 kHz	A	-	1.8	2.4	3.2
4 kHz	A	1.3	1.8	2.4	3.2
8 kHz	A	1.3	1.8	2.4	3.2
16 kHz	A	0.9	1.2	1.6	2.1
Power loss					
4 kHz	W	20	25	32	40
8 kHz	W	24	31	40	51
at controller inhibit	W	6	6	6	6
Overcurrent cycle 180 s					
Max. output current	A	2	2.7	3.6	4.8
Overload time	s	60	60	60	60
Recovery time	s	120	120	120	120
Max. output current during the recovery time	A	1	1.4	1.8	2.4
Overcurrent cycle 15 s					
Max. output current	A	2.6	3.6	4.8	6.4
Overload time	s	3	3	3	3
Recovery time	s	12	12	12	12
Max. output current during the recovery time	A	1	1.4	1.8	2.4
Max. motor cable length shielded					
without EMC category	m	15	50		
Category C2	m	15			20
Weight	kg	0.75	0.95		1.35



Technical data

3-phase mains connection 400 V
Rated data

Inverter		i510-C1.5/400-3	i510-C2.2/400-3
Rated power	kW	1.5	2.2
Mains voltage range		3/PE AC 340 V ... 528 V, 45 Hz ... 65 Hz	
Rated mains current			
without mains choke	A	5.4	7.8
with mains choke	A	3.7	5.3
Apparent output power	kVA	2.6	3.6
Output current			
2 kHz	A	3.9	5.6
4 kHz	A	3.9	5.6
8 kHz	A	3.9	5.6
16 kHz	A	2.6	3.7
Power loss			
4 kHz	W	48	66
8 kHz	W	61	85
at controller inhibit	W	6	6
Overcurrent cycle 180 s			
Max. output current	A	5.9	8.4
Overload time	s	60	60
Recovery time	s	120	120
Max. output current during the recovery time	A	2.9	4.2
Overcurrent cycle 15 s			
Max. output current	A	7.8	11.2
Overload time	s	3	3
Recovery time	s	12	12
Max. output current during the recovery time	A	2.9	4.2
Max. motor cable length shielded			
without EMC category	m	50	
Category C2	m	20	
Weight	kg	1.35	

Technical data

3-phase mains connection 400 V
Fusing and terminal data



Fusing and terminal data

Inverter		i510-C0.37/400-3	i510-C0.55/400-3	i510-C0.75/400-3	i510-C1.1/400-3
Cable installation in compliance with		EN 60204-1			
Laying system		B2			
operation		without mains choke			
Fuse					
Characteristics		gG/gL or gRL			
Max. rated current	A	10	10	10	16
Circuit breaker					
Characteristics		B			
Max. rated current	A	10	10	10	16
operation		with mains choke			
Fuse					
Characteristics		gG/gL or gRL			
Max. rated current	A	10	10	10	16
Circuit breaker					
Characteristics		B			
Max. rated current	A	10	10	10	16
Earth-leakage circuit breaker					
3-phase mains connection		≥ 30 mA, type B			
Mains connection					
Connection		X100			
Connection type		pluggable screw terminal			
Min. cable cross-section	mm ²	1			
Max. cable cross-section	mm ²	2.5			
Stripping length	mm	8			
Tightening torque	Nm	0.5			
Required tool		0.5 x 3.0			
Motor connection					
Connection		X105			
Connection type		pluggable screw terminal			
Min. cable cross-section	mm ²	1			
Max. cable cross-section	mm ²	2.5			
Stripping length	mm	8			
Tightening torque	Nm	0.5			
Required tool		0.5 x 3.0			



Technical data

3-phase mains connection 400 V

Fusing and terminal data

Inverter		i510-C1.5/400-3	i510-C2.2/400-3
Cable installation in compliance with		EN 60204-1	
Laying system		B2	
operation		without mains choke	
Fuse			
Characteristics		gG/gL or gRL	
Max. rated current	A	16	16
Circuit breaker			
Characteristics		B	
Max. rated current	A	16	16
operation		with mains choke	
Fuse			
Characteristics		gG/gL or gRL	
Max. rated current	A	16	16
Circuit breaker			
Characteristics		B	
Max. rated current	A	16	16
Earth-leakage circuit breaker			
3-phase mains connection		≥ 30 mA, type B	
Mains connection			
Connection		X100	
Connection type		pluggable screw terminal	
Min. cable cross-section	mm ²	1	
Max. cable cross-section	mm ²	2.5	
Stripping length	mm	8	
Tightening torque	Nm	0.5	
Required tool		0.5 x 3.0	
Motor connection			
Connection		X105	
Connection type		pluggable screw terminal	
Min. cable cross-section	mm ²	1	
Max. cable cross-section	mm ²	2.5	
Stripping length	mm	8	
Tightening torque	Nm	0.5	
Required tool		0.5 x 3.0	

Technical data

3-phase mains connection 480 V
Rated data



3-phase mains connection 480 V

Rated data

The output currents apply to these operating conditions:

- At a switching frequency of 2 kHz or 4 kHz: Max. ambient temperature 45°C.
- At a switching frequency of 8 kHz or 16 kHz: Max. ambient temperature 40 °C.

Inverter		i510-C0.37/400-3	i510-C0.55/400-3	i510-C0.75/400-3	i510-C1.1/400-3
Rated power	kW	0.37	0.55	0.75	1.1
Mains voltage range		3/PE AC 340 V ... 528 V, 45 Hz ... 65 Hz			
Rated mains current					
without mains choke	A	1.5	2.1	2.8	3.7
with mains choke	A	1.2	1.7	2.2	2.5
Apparent output power	kVA	0.9	1.2	1.6	2.2
Output current					
2 kHz	A	-	1.6	2.1	3
4 kHz	A	1.1	1.6	2.1	3
8 kHz	A	1.1	1.6	2.1	3
16 kHz	A	0.7	1.1	1.4	2
Power loss					
4 kHz	W	20	25	32	40
8 kHz	W	24	31	40	51
at controller inhibit	W	6	6	6	6
Overcurrent cycle 180 s					
Max. output current	A	1.7	2.4	3.2	4.5
Overload time	s	60	60	60	60
Recovery time	s	120	120	120	120
Max. output current during the recovery time	A	0.8	1.2	1.6	2.3
Overcurrent cycle 15 s					
Max. output current	A	2.2	3.2	4.2	6
Overload time	s	3	3	3	3
Recovery time	s	12	12	12	12
Max. output current during the recovery time	A	0.8	1.2	1.6	2.3
Max. motor cable length shielded					
without EMC category	m	15	50		
Category C2	m	15			20
Weight	kg	0.75	0.95		1.35



Technical data

3-phase mains connection 480 V
Rated data

Inverter		i510-C1.5/400-3	i510-C2.2/400-3
Rated power	kW	1.5	2.2
Mains voltage range		3/PE AC 340 V ... 528 V, 45 Hz ... 65 Hz	
Rated mains current			
without mains choke	A	4.5	6.5
with mains choke	A	3.1	4.4
Apparent output power	kVA	2.6	3.6
Output current			
2 kHz	A	3.5	4.8
4 kHz	A	3.5	4.8
8 kHz	A	3.5	4.8
16 kHz	A	2.3	3.2
Power loss			
4 kHz	W	48	66
8 kHz	W	61	85
at controller inhibit	W	6	6
Overcurrent cycle 180 s			
Max. output current	A	5.3	7.2
Overload time	s	60	60
Recovery time	s	120	120
Max. output current during the recovery time	A	2.6	3.6
Overcurrent cycle 15 s			
Max. output current	A	7	9.6
Overload time	s	3	3
Recovery time	s	12	12
Max. output current during the recovery time	A	2.6	3.6
Max. motor cable length shielded			
without EMC category	m	50	
Category C2	m	20	
Weight	kg	1.35	

Technical data

3-phase mains connection 480 V
Fusing and terminal data



Fusing and terminal data

Inverter		i510-C0.37/400-3	i510-C0.55/400-3	i510-C0.75/400-3	i510-C1.1/400-3
Cable installation in compliance with		EN 60204-1			
Laying system		B2			
operation		without mains choke			
Fuse					
Characteristics		gG/gL or gRL			
Max. rated current	A	10	10	10	16
Circuit breaker					
Characteristics		B			
Max. rated current	A	10	10	10	16
operation		with mains choke			
Fuse					
Characteristics		gG/gL or gRL			
Max. rated current	A	10	10	10	16
Circuit breaker					
Characteristics		B			
Max. rated current	A	10	10	10	16
Earth-leakage circuit breaker					
3-phase mains connection		≥ 30 mA, type B			
Mains connection					
Connection		X100			
Connection type		pluggable screw terminal			
Min. cable cross-section	mm ²	1			
Max. cable cross-section	mm ²	2.5			
Stripping length	mm	8			
Tightening torque	Nm	0.5			
Required tool		0.5 x 3.0			
Motor connection					
Connection		X105			
Connection type		pluggable screw terminal			
Min. cable cross-section	mm ²	1			
Max. cable cross-section	mm ²	2.5			
Stripping length	mm	8			
Tightening torque	Nm	0.5			
Required tool		0.5 x 3.0			



Technical data

3-phase mains connection 480 V

Fusing and terminal data

Inverter		i510-C1.5/400-3	i510-C2.2/400-3
Cable installation in compliance with		EN 60204-1	
Laying system		B2	
operation		without mains choke	
Fuse			
Characteristics		gG/gL or gRL	
Max. rated current	A	16	16
Circuit breaker			
Characteristics		B	
Max. rated current	A	16	16
operation		with mains choke	
Fuse			
Characteristics		gG/gL or gRL	
Max. rated current	A	16	16
Circuit breaker			
Characteristics		B	
Max. rated current	A	16	16
Earth-leakage circuit breaker			
3-phase mains connection		≥ 30 mA, type B	
Mains connection			
Connection		X100	
Connection type		pluggable screw terminal	
Min. cable cross-section	mm ²	1	
Max. cable cross-section	mm ²	2.5	
Stripping length	mm	8	
Tightening torque	Nm	0.5	
Required tool		0.5 x 3.0	
Motor connection			
Connection		X105	
Connection type		pluggable screw terminal	
Min. cable cross-section	mm ²	1	
Max. cable cross-section	mm ²	2.5	
Stripping length	mm	8	
Tightening torque	Nm	0.5	
Required tool		0.5 x 3.0	

Technical data

Dimensions

0.25 kW ... 0.37 kW



Dimensions

0.25 kW ... 0.37 kW

The dimensions in mm apply to:

0.25 kW

i510-C0.25/230-1

i510-C0.25/230-2

0.37 kW

i510-C0.37/230-1

i510-C0.37/230-2

i510-C0.37/400-3

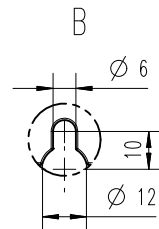
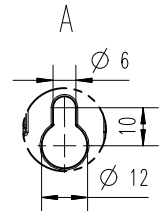
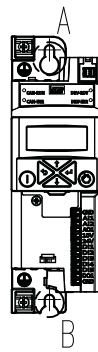
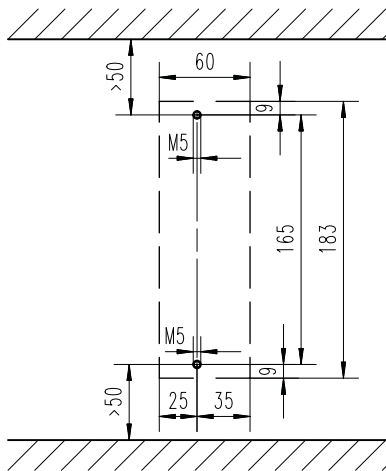
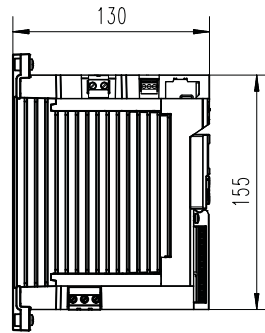
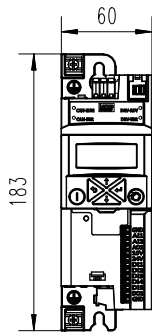

8800270



Technical data

Dimensions
0.55 kW ... 0.75 kW

0.55 kW ... 0.75 kW

The dimensions in mm apply to:

0.55 kW	0.75 kW
i510-C0.55/230-1	i510-C0.75/230-1
i510-C0.55/230-2	i510-C0.75/230-2
i510-C0.55/400-3	i510-C0.75/400-3

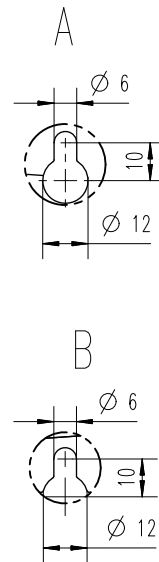
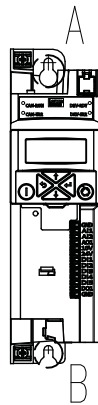
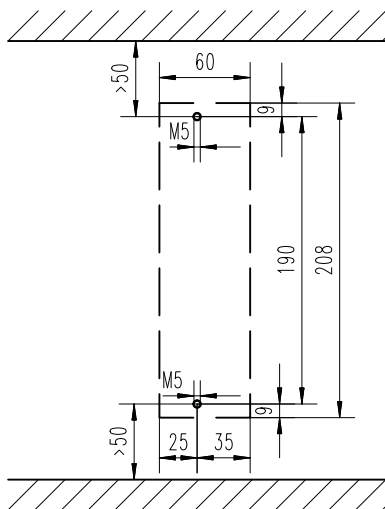
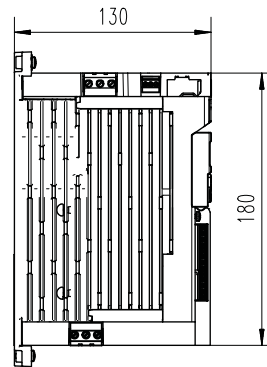
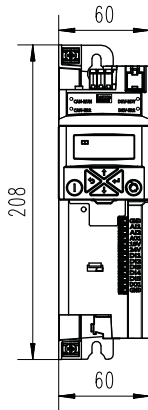

8800271

Technical data

Dimensions

1.1 kW ... 2.2 kW



1.1 kW ... 2.2 kW

The dimensions in mm apply to:

1.1 kW

i510-C1.1/230-1

i510-C1.1/230-2

i510-C1.1/400-3

1.5 kW

i510-C1.5/230-1

i510-C1.5/230-2

i510-C1.5/400-3

2.2 kW

i510-C2.2/230-1

i510-C2.2/230-2

i510-C2.2/400-3

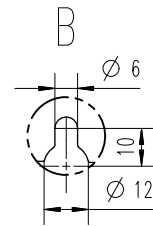
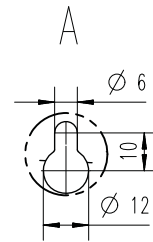
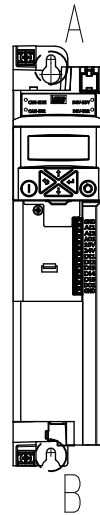
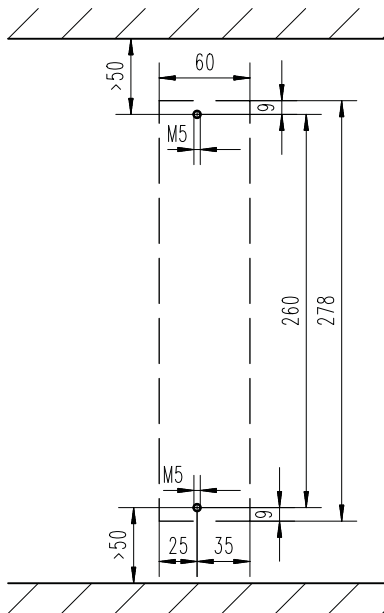
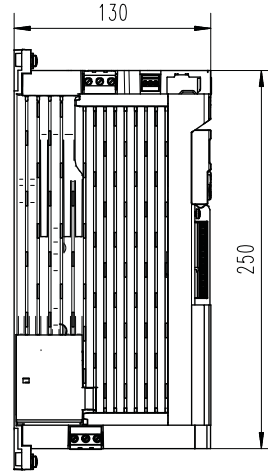
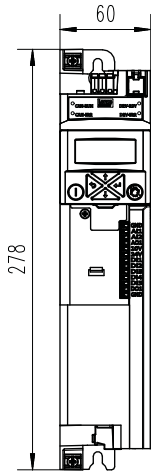

8800272



Product extensions

Overview

The inverters can be easily integrated into the machine. The scalable product extensions serve to flexibly match the required functions to your application.

The integrated standard product extension for the inverter i510 is the control unit with basic I/O.

As the control unit cannot be extended, the inverter i510 is available in two versions:

- With CANopen/Modbus, switchable.
- Without network.

In order to provide a largely uniform documentation, all information and data of the control unit with basic I/O are contained here in the product extension chapter.



Inverter
without network



Inverter
with CANopen and Modbus

Product extensions

I/O extensions
Basic I/Os



I/O extensions

Basic I/Os

The basic I/O provides the inverter analog and digital inputs and outputs and is designed for simple applications.

The basic I/O can be purchased with or without the CANopen and Modbus networks. A switch can be used to select between the two networks.

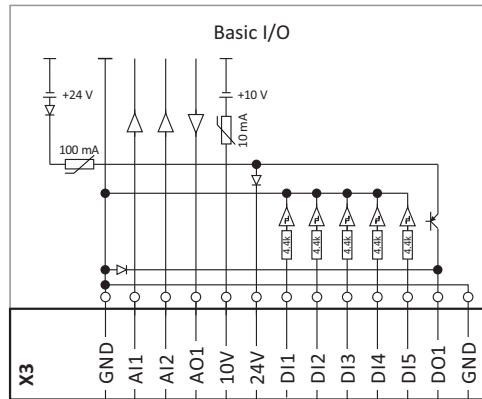

Digital inputs	Terminal X3: DI1, DI2, DI3, DI4, DI5	HIGH active
Digital outputs	Terminal X3: DO1	
Analog inputs	Terminal X3: AI1, AI2	AI1: Can be optionally used as voltage or current input. AI2: Can be used as voltage input.
Analog output	Terminal X3: AO1	Can be optionally used as voltage or current output.
10-V output	Terminal X3: 10V	Reference voltage or setpoint potentiometer
24-V output	Terminal X3: 24V	
Reference potential	Terminal X3: GND	
Connection system	Pluggable spring terminal	



Data of control connections

Digital inputs

Switching type		PNP	
PNP switching level			
LOW	V	< +5	IEC 61131-2, type 1
HIGH	V	> +15	
Input resistance	kΩ	4.6	
Cycle time	ms	1	can be changed by software filtering
Electric strength of external voltage	V	± 30	

Encoder input			
Type		Incremental HTL encoder	
Two-track connection		X3/DI3 X3/DI4	Track A Track B
Frequency range	kHz	0 ... 100	

Digital outputs

Switching level			
LOW	V	< +5	IEC 61131-2, type 1
HIGH	V	> +15	
max. output current	mA	100	Total current for DO1 and 24V
Cycle time	ms	1	
Short-circuit strength		Unlimited period	
Electric strength of external voltage	V	± 30	
Polarity reversal protection		Integrated freewheeling diode for switching the inductive load	
Overload behaviour		Reduced voltage or periodic switch-off/on	
Reset or switch-on behaviour		Output is switched off	LOW

Analog inputs

Cycle time	ms	1	
Resolution of A/D converter	Bit	12	
Operation as voltage input			
Connection designation		X3/AI1, X3/AI2	
Input voltage DC	V	0 ... 10	
Input resistance	kΩ	70	
Accuracy	mV	± 50	Typical
Input voltage in case of open circuit	V	- 0.2 ... 0.2	Display "0"
Electric strength of external voltage	V	± 24	
Operation as current input			
Connection designation		X3/AI1	
Input current	mA	0 ... 20 4 ... 20	open-circuit monitored
Accuracy	mA	± 0.1	Typical
Input current in case of open circuit	mA	< 0.1	Display "0"
Input resistance	Ω	< 250	
Electric strength of external voltage	V	± 24	

Product extensions

I/O extensions
Data of control connections



Analog outputs

Short-circuit strength		Unlimited period	
Electric strength of external voltage	V	+ 24V	
Operation as voltage output			
Resolution of D/A converter	Bit	12	
Output voltage DC	V	0 ... 10	
max. output current	mA	5	
Max. capacitive load	μF	1	
Accuracy	mV	± 100	Typical
Operation as current output			
Output current	mA	0 ... 20	
		4 ... 20	open-circuit monitored
Accuracy	mA	± 0.3	Typical

10-V output

Use		Primarily for the supply of a potentiometer (1 ... 10 kΩ)	
Output voltage DC			
Typical	V	10	
Accuracy	mV	± 100	
Max. output current	mA	10	
Max. capacitive load	μF	1	
Short-circuit strength		Unlimited period	
Electric strength of external voltage	V	+ 24	

24-V output

Use		Primarily for the supply of digital inputs	
Output voltage DC			
Typical	V	24	
Area	V	16 ... 28	
max. output current	mA	100	Total current for DO... and 24V
Short-circuit strength		Unlimited period	
Electric strength of external voltage	V	+ 30	
Excess current release		Automatically resettable	

Terminal description		Control terminals
Connection		X3
Connection type		Spring terminal
Min. cable cross-section	mm ²	0.5
Max. cable cross-section	mm ²	1.5
Stripping length	mm	9
Tightening torque	Nm	-
Required tool		0.4 x 2.5



More control connections

Relay output



Relay is not suitable for direct switching of a electromechanical holding brake!

Use a corresponding suppressor circuit in case of an inductive or capacitive load!

Connection		Terminal X9: COM	Centre contact (common)	
		Terminal X9: NC	Normally-closed contact	
		Terminal X9: NO	Normally-open contact	
Minimum DC contact load				
	Voltage	V	10	A correct switching of the relay contacts needs both values to be exceeded simultaneously.
	Current	mA	10	
Switching voltage/switching current				
Maximum	AC 240 V	A	3	According to UL: General Purpose
	DC 24 V	A	2	According to UL: Resistive
	DC 240 V	A	0.16	

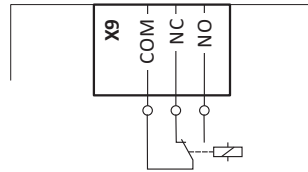

Terminal description	Relay output	
Connection	X9	
Connection type	pluggable screw terminal	
Min. cable cross-section	mm ²	0.5
Max. cable cross-section	mm ²	1.5
Stripping length	mm	6
Tightening torque	Nm	0.2
Required tool	0.4 x 2.5	

Product extensions

Networks
CANopen/Modbus



Networks

The integrated standard product extension for the inverter i510 is the control unit with basic I/O.

As the control unit cannot be extended, the inverter i510 is available in two versions:

- With CANopen/Modbus, switchable.
- Without network.

In order to provide a largely uniform documentation, all information and data of the control unit with basic I/O are contained here in the product extension chapter.

CANopen/Modbus

General information			
Design		Inverter version	<ul style="list-style-type: none"> • No retrofitting possible. • Integrated in the complete device.
Mains-dependent voltage supply of the control electronics and optional fieldbus		internally via the inverter	
Mains-independent voltage supply		not possible	

Bus-related information				
Name		CANopen DS301 V4.02	Modbus RTU	Selection via DIP switch
Use		Connection of the inverter to a CANopen network	Connection of the inverter to a Modbus network	
Connection system		pluggable double spring terminal		
Status display		2 LEDs		
Connection designation		X216: CH/TB, CL/TA, CG/COM		
integrated bus terminating resistor		No		External wiring required

Typical topologies

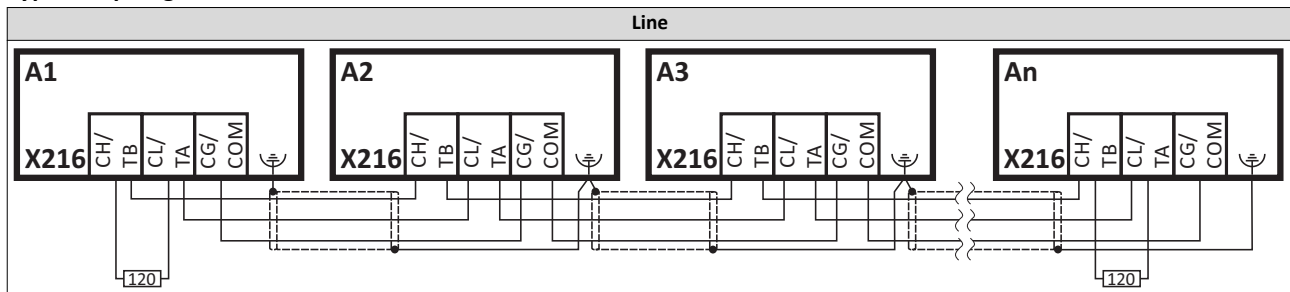

Terminal description	CANopen/Modbus	
Connection		X216
Connection type		pluggable spring terminal
Min. cable cross-section	mm ²	0.5
Max. cable cross-section	mm ²	2.5
Stripping length	mm	10
Tightening torque	Nm	-
Required tool		0.4 x 2.5



CANopen

CANopen is an internationally approved communication protocol which is designed for commercial and industrial automation applications. High data transfer rates in connection with efficient data formatting provide for the coordination of motion control devices in multi-axis applications.

Technical data			
Bus terminating resistor	Ω	120	Terminated on both sides
integrated bus terminating resistor		No	External wiring required
Network topology			
Without repeater		Line	
With repeater		Line or tree	
Station			
Type		Slave	
Max. number without repeater		127	per bus segment, incl. host system
Address		1 ... 127	Adjustable via code or DIP switch
Baud rate	kbps	20, 50, 125, 250, 500, 800 or 1000	Adjustable via code or DIP switch
Max. bus length	m	2500, 1000, 500, 250, 100, 50 or 25	Total cable length depends on the baud rate
Max. cable length between two nodes		not limited, the max. bus length is decisive	
Process data			
Transmit PDOs		3 TPDOs with 1 ... 8 bytes (adjustable)	
Receive PDOs		3 RPDOs with 1 ... 8 bytes (adjustable)	
Transmission mode for TPDOs			
With change of data		Yes	
Time-controlled, multiple of	ms	10	
After reception		1 ... 240 sync telegrams	
Parameter data			
SDO channels		Max. 2 servers	

Modbus

Modbus is an internationally approved, asynchronous, serial communication protocol, designed for commercial and industrial automation applications.

Technical data			
Communication profile		Modbus RTU	
Bus terminating resistor	Ω	120	Terminated on both sides
integrated bus terminating resistor		No	External wiring required
Network topology			
Without repeater		Line	
Station			
Type		Slave	
Max. number without repeater		32	per bus segment, incl. host system
Max. number with repeater		90	
Address		1 ... 247	Adjustable via code or DIP switch
Baud rate	kbps	4.8 ... 115	Adjustable via code or DIP switch, alternatively automatic detection via DIP switch can be activated
Max. cable length	m	12 ... 600	Per bus segment, depending on the baud rate and the used cable type
Max. cable length between two nodes		not limited, the max. bus length is decisive	
Data channel			
SDO channels		Max. 2 servers, with 1 ... 8 bytes	Supported functions: Read Holding Registers Preset Single Register Preset Multiple Registers Read/Write 4 x registers



Accessories

Overview

A package of accessories optimally matched to the inverter is available for your applications.

Moreover, the pluggable modules make commissioning and diagnostics easier.

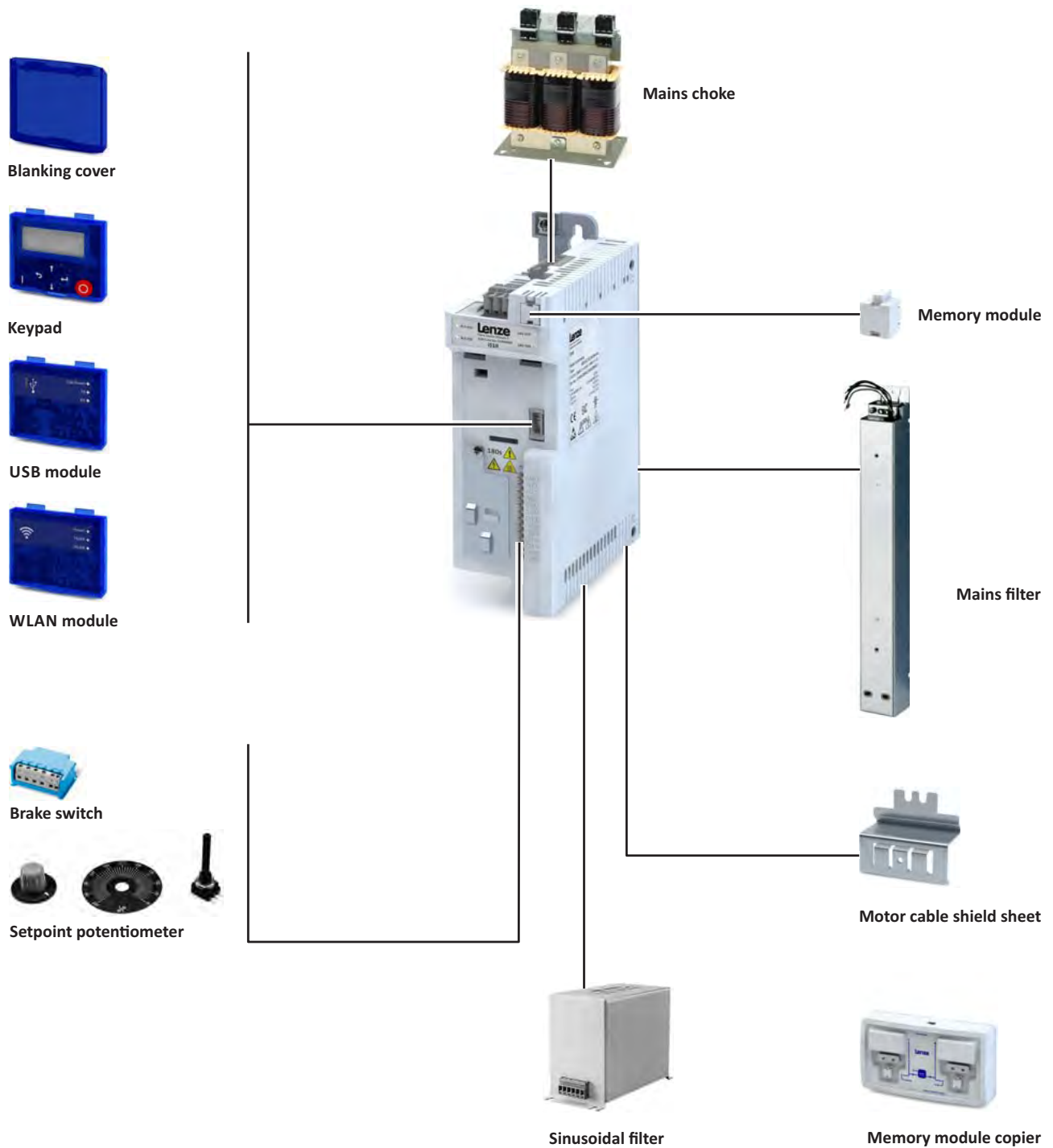



Operation and diagnostics

Keypad

Parameter setting and diagnostics

Thanks to the intuitive operating structure, the navigation keys allow a quick and easy access to the most important parameters, either to configure functions or to query current values. Parameters and actual values are indicated on the easy-to-read display.



Keypad	
Order code	Design
I5MADK0000000S	7-digit LED display Display in German/English

USB module

Interface to the PC

The USB 2.0-connecting cable is used to connect the inverter with a PC with the »EASY Starter« Lenze Engineering Tool. The »EASY Starter« serves to configure the inverter via graphical interfaces. They create diagnostics with trend functions or monitor parameter values.

Parameterising without supplying the inverter with voltage: If you connect the inverter directly to the PC without a hub, in many cases the USB interface of the PC is sufficient for the voltage supply.



USB module	
Order code	Version
I5MADU0000000S	Parameter setting without voltage supply of the inverter USB 2.0 connecting cable required

Connecting cable		
Order code	Length	Version
EWL0085/S	3 m	USB 2.0-connecting cable (A plug to micro-B plug)
EWL0086/S	5 m	

Accessories

Operation and diagnostics
WLAN module



WLAN module

The wireless interface

Wireless communication with the inverter.

- via a PC with the Lenze «EASY Starter» Engineering Tool or
- via the Lenze Smart keypad app for Android smartphones.

The app is recommended for adapting easy applications. The clearly arranged user interface of the app guides you intuitively and safely through all the menus. Operation corresponds to key-pad operation.



The Lenze Smart keypad app can be found in the Google Play Store.



WARNING!

- ▶ This product contains FCC ID: QQQWF121/IC: 5123A-BGTWF121
 - ▶ To comply with FCC and Industry Canada RF radiation exposure limits for general population, the transmitter with its antenna must be installed such that a minimum separation distance of 20 cm is maintained between the radiator (antenna) and all persons at all times.
 - ▶ This product must not be collocated or operated in conjunction with any other antenna or transmitter.
-
- ▶ Le produit contient un module transmetteur certifié FCC ID: QQQWF121/IC: 5123A-BGTWF121
 - ▶ Afin de se conformer aux réglementations de la FCC et d'Industry Canada relatives aux limites d'exposition aux rayonnements RF pour le grand public, le transmetteur et son antenne doivent être installés de sorte qu'une distance minimale de 20 cm soit constamment maintenue entre le radiateur (antenne) et toute personne.
 - ▶ Le produit ne doit pas être utilisé en combinaison avec d'autres antennes ou transmetteurs.



LED status displays			
LED 1	LED 2	LED 3	Meaning
Power (green)	TX/RX (yellow)	WLAN (green)	
Supply voltage status	Communication status	WLAN status	
OFF	OFF	OFF	No voltage
ON	ON	ON	Self-test (approx. 1 s)
ON	OFF	OFF	Ready for operation No active WLAN connection
ON	Flashing	ON	Communication active
ON	OFF	Blinking	Client Mode Waiting for connection
Blinking	OFF	OFF	Trouble

Additional conformities and approvals		
CE	R&TTE/RED	EN 301489-1 V1.9.2:2011
		EN 301489-17 V2.2.1:2012
		EN 300328 V1.8.1:2012-06
FCC	Part 15.107/15.109 ICES-003	

Connection data (default setting)	
IP address	192.168.178.1
SSID	<Product type>_<10-digit identifier>
Password	password

WLAN module	
Order code	Design
I5MADW00000005	Range in open space: 100 m, conditions on site may restrict the range.

Blanking cover

Protection and optics

The blanking cover protects the terminals and provides for uniform optics if no other module is plugged on.



Blanking cover		
Order code	Version	VPE
		Piece
I5ZAA0000M	Protection against dust Uniform optics	4

Accessories

Operation and diagnostics
Setpoint potentiometer



Setpoint potentiometer

For the external selection of an analog setpoint.

The setpoint selection (e.g. motor speed) can be manually set via the external potentiometer. The setpoint potentiometer is connected to the analog input terminals of the inverter.

The position is displayed on the scale via the rotary knob.

The components have to be ordered separately.



Setpoint potentiometer		
Order code	Name	Version
ERPD0010K0001W	Potentiometer	10 kΩ/1 W
ERZ0001	Rotary knob	Diameter 36 mm
ERZ0002	Scale	Scale 0 ... 100 %, Diameter 62 mm

Memory modules

For standard set-up, Lenze offers its customers multipacked, unwritten memory modules (EPM). Together with the EPM copier, the EPMs can be duplicated at any place.

A memory module is included in the scope of supply of the inverter.



Memory module		
Order code	Version	VPE
		Piece
I0MAPA0000000M	Easily pluggable Duplicate data set with memory module copier	12

Memory module copier

For duplicating data on memory modules for a faster standard set-up.

The memory module copier is a copying system for all memory modules from Lenze. With the help of simple optical user guidance, the data of a module is copied quickly and reliably to another memory module.



Memory module copier	
Order code	Version
EZAEDE1001	Data set copier for memory modules



Mains chokes

Mains chokes reduce the effects of the inverter on the supplying mains.

The switching operations in the inverter cause high-frequency interferences that will be transmitted unfiltered to the supplying mains. Mains chokes smooth the steep and pulse-like curves coming from the Inverter and make them more sinusoidal. Moreover, the effective mains current is reduced and thus energy is saved.

Mains chokes can be used without restrictions in conjunction with RFI filters.

Please note that the use of a mains choke reduces the mains voltage at the input of the inverter. The typical voltage drop across the mains choke is around 4 % at its rated point.



1-phase mains connection 230/240 V

Inverter	Mains choke			
	Order code	Number of phases	Rated current	Inductance
			A	mH
i510-C0.25/230-1	ELN1-0900H005	1	5	9
i510-C0.37/230-1				
i510-C0.55/230-1	ELN1-0500H009		9	5
i510-C0.75/230-1				
i510-C1.1/230-1	ELN1-0250H018		18	2.5
i510-C1.5/230-1				
i510-C2.2/230-1				

1/3-phase mains connection 230/240 V

Inverter	Mains choke			
	Order code	Number of phases	Rated current	Inductance
			A	mH
i510-C0.25/230-2	ELN1-0900H005	1	5	9
	EZAELN3002B153	3	2	14.7
i510-C0.37/230-2	ELN1-0900H005	1	5	9
	EZAELN3004B742	3	4	7.35
i510-C0.55/230-2	ELN1-0500H009	1	9	5
	EZAELN3004B742	3	4	7.35
i510-C0.75/230-2	ELN1-0500H009	1	9	5
	EZAELN3006B492	3	6	4.9
i510-C1.1/230-2	ELN1-0250H018	1	18	2.5
	EZAELN3006B492	3	6	4.9
i510-C1.5/230-2	ELN1-0250H018	1	18	2.5
	EZAELN3008B372	3	8	3.68
i510-C2.2/230-2	ELN1-0250H018	1	18	2.5
	EZAELN3010B292	3	10	2.94

Accessories

Mains chokes

3-phase mains connection 400 V



3-phase mains connection 400 V

Inverter	Mains choke			
	Order code	Number of phases	Rated current A	Inductance mH
i510-C0.37/400-3	EZAELN3002B203	3	1.5	19.6
i510-C0.55/400-3	EZAELN3002B153		2	14.7
i510-C0.75/400-3	EZAELN3004B742		4	7.35
i510-C1.1/400-3			4	7.35
i510-C1.5/400-3			4	7.35
i510-C2.2/400-3	EZAELN3006B492		6	4.9

3-phase mains connection 480 V

Inverter	Mains choke			
	Order code	Number of phases	Rated current A	Inductance mH
i510-C0.37/400-3	EZAELN3002B203	3	1.5	19.6
i510-C0.55/400-3	EZAELN3002B153		2	14.7
i510-C0.75/400-3	EZAELN3004B742		4	7.35
i510-C1.1/400-3			4	7.35
i510-C1.5/400-3			4	7.35
i510-C2.2/400-3	EZAELN3006B492		6	4.9



RFI filters / Mains filters

RFI and mains filters are used to ensure compliance with the EMC requirements of European Standard EN 61800-3. This standard defines the EMC requirements for electrical drive system in various categories.

Definition of the environments

(EN 61800-3)

First environment

The first environment comprises residential buildings or locations that are directly connected to a low-voltage system for supplying residential areas.

Second environment

The second environment comprises facilities or locations that are not directly connected to a low-voltage system for supplying residential areas.

Category C1

Category C1 defines the requirements for drive systems that are intended for the use in the first environment at a rated voltage lower than 1000 V.

The limit values of the EN 61800-3 comply with EN 55011 class B.

Category C2

Category C2 defines the requirements for permanently installed drive systems that are intended for the use in the first environment at a rated voltage lower than 1000 V. Installation and commissioning must only be carried out by qualified personnel with EMC knowledge.

The limit values of the EN 61800-3 comply with EN 55011 class A group 1.

Category C3

Category C3 defines the requirements for drive systems that are exclusively intended for the use in the second environment at a rated voltage lower than 1000 V.

The limit values of the EN 61800-3 comply with EN 55011 class A group 2.



When working with stricter line-bound noise emission requirements which cannot be met using the radio interference suppression measures integrated in the inverter, external filters can be used. The filters can be installed below or next to the inverter.

If necessary, the internal filters have to be deactivated when external filters are used. For this purpose, remove the IT screws of the inverters.





Comparison of integrated and external RFI filters

RFI filters		Filter types			
		Integrated in the inverter	External		
			Low Leakage	Short Distance	Long Distance
Use	In standard applications.	In mobile systems.	With short cable length.	At switching frequencies 4 kHz and 8 kHz.	
Optimisation	Easy use.	For low leakage current.	For low leakage current.	For long motor cable.	
Reduces noise emissions	Cable-guided and radiated	Cable-guided	Cable-guided	Cable-guided	

Mains connection		1-phase, 230 V			
Inverter		i510-C0.25/230-1 i510-C0.37/230-1	i510-C0.55/230-1 i510-C0.75/230-1	i510-C1.1/230-1 i510-C1.5/230-1 i510-C2.2/230-1	
With integrated RFI filter					
Without EMC category Thermal limitation	Shielded motor cable length	m	50	50	50
	Unshielded motor cable length	m	100	100	200
With integrated RFI filter					
Category C1	Shielded motor cable length	m	-	-	-
Category C2		m	15	20	20
	Earth-leakage circuit breaker	mA	30	30	30
RFI filter Low Leakage					
Category C1	Shielded motor cable length	m	5	5	5
	Earth-leakage circuit breaker	mA	10	10	10
RFI filter Short Distance					
Category C1	Shielded motor cable length	m	25	25	25
Category C2		m	50	50	50
	Earth-leakage circuit breaker	mA	30	30	30
RFI filter Long Distance					
Category C1	Shielded motor cable length	m	50	50	50
Category C2		m	50	50	50
	Earth-leakage circuit breaker	mA	300	300	300



Mains connection			3-phase, 400 V		
Inverter			i510-C0.37/400-3	i510-C0.55/400-3 i510-C0.75/400-3	i510-C1.1/400-3 i510-C1.5/400-3 i510-C2.2/400-3
With integrated RFI filter					
Without EMC category	Shielded motor cable length	m	15	50	50
Thermal limitation	Unshielded motor cable length	m	30	100	200
With integrated RFI filter					
Category C1	Shielded motor cable length	m	-	-	-
Category C2		m	15	15	20
	Earth-leakage circuit breaker	mA	30	30	30
RFI filter Low Leakage					
Category C1	Shielded motor cable length	m	-	-	-
	Earth-leakage circuit breaker	mA	-	-	-
RFI filter Short Distance					
Category C1	Shielded motor cable length	m	15	25	25
Category C2		m	15	50	50
	Earth-leakage circuit breaker	mA	30	30	30
RFI filter Long Distance					
Category C1	Shielded motor cable length	m	15	50	50
Category C2		m	15	50	50
	Earth-leakage circuit breaker	mA	300	300	300

Low Leakage

Inverter	RFI filters	
	Order code	Rated current
	A	
i510-C0.25/230-1	IOFAE175B100L0000S	9
i510-C0.37/230-1		
i510-C0.55/230-1		
i510-C0.75/230-1		
i510-C1.1/230-1	IOFAE222B100L0000S	21.8
i510-C1.5/230-1		
i510-C2.2/230-1		

Accessories

RFI filters / Mains filters



Short Distance

Inverter	RFI filters	
	Order code	Rated current
		A
i510-C0.25/230-1	IOFAE175B100S0000S	9
i510-C0.37/230-1		
i510-C0.55/230-1		
i510-C0.75/230-1		
i510-C1.1/230-1	IOFAE222B100S0000S	21.8
i510-C1.5/230-1		
i510-C2.2/230-1		
i510-C0.37/400-3	IOFAE175F100S0000S	3.3
i510-C0.55/400-3		
i510-C0.75/400-3		
i510-C1.1/400-3	IOFAE222F100S0000S	7.3
i510-C1.5/400-3		
i510-C2.2/400-3		

Long Distance

Inverter	RFI filters	
	Order code	Rated current
		A
i510-C0.25/230-1	IOFAE175B100D0000S	9.0
i510-C0.37/230-1		
i510-C0.55/230-1		
i510-C0.75/230-1		
i510-C1.1/230-1	IOFAE222B100D0000S	21.8
i510-C1.5/230-1		
i510-C2.2/230-1		
i510-C0.37/400-3	IOFAE175F100D0000S	3.3
i510-C0.55/400-3		
i510-C0.75/400-3		
i510-C1.1/400-3	IOFAE222F100D0000S	7.3
i510-C1.5/400-3		
i510-C2.2/400-3		



Sine filter

A sinusoidal filter in the motor cable limits the rate of voltage rise and the capacitive charge/discharge currents that occur during inverter operation.



Only use a sinusoidal filter with standard asynchronous motors 0 to 550 V.

Operation only with V/f or square-law V/f characteristic control.

Set the switching frequency permanently to the specified value.

Limit the output frequency of the inverter to the given value.



Inverter	Sine filter			
	Switching frequency	Order code	Rated inductance	Max. output frequency
	kHz		mH	Hz
i510-C0.37/400-3	4 8	EZS3-004A200	11.0	150
i510-C0.55/400-3				
i510-C0.75/400-3				
i510-C1.1/400-3				
i510-C1.5/400-3		EZS3-010A200	5.10	
i510-C2.2/400-3				

Brake switches

For switching an electromechanical brake.

The brake switch consists of a rectifier and an electronic circuit breaker.

It is mounted on the control cabinet plate by means of two screws. Control is performed using a digital output on the inverter.



Brake switches		Half-wave rectifiers	Bridge rectifiers
Order code		E82ZWBRE	E82ZWBRB
Input voltage	V	AC 320 - 550	AC 180 - 317
Output voltage	V	DC 180 (with AC 400) DC 225 (with AC 500)	DC 205 (with AC 230)
Max. brake current	A	0.61	0.54

Accessories

Mounting
Shield mounting kit



Mounting

Shield mounting kit

Motor cable

If the shielding of the motor cable is centrally connected to an earthing bus in the control cabinet, no shielding is required.

For a direct connection of the shielding of the motor cable to the inverter, the optionally available accessories can be used consisting of shield sheet and fixing clips or wire clamps.



Inverter	Shield mounting kit	
	Order code	VPE
		Piece
i510-C0.25/230-1	EZAMBHXM014	5x motor shield sheet 10x fixing clips
i510-C0.25/230-2		
i510-C0.37/230-1		
i510-C0.37/230-2		
i510-C0.55/230-1		
i510-C0.55/230-2		
i510-C0.75/230-1		
i510-C0.75/230-2		
i510-C1.1/230-1		
i510-C1.1/230-2		
i510-C1.5/230-1		
i510-C1.5/230-2		
i510-C2.2/230-1		
i510-C2.2/230-2		
i510-C0.37/400-3		
i510-C0.55/400-3		
i510-C0.75/400-3		
i510-C1.1/400-3		
i510-C1.5/400-3		
i510-C2.2/400-3		



Terminal strips

For connecting the inverter, the connections are equipped with pluggable terminal strips. Pluggable terminal strips are available separately for service purposes or if cable harnesses need to be physically separated.

Inverter	Terminal strips Mains connection X100		Terminal strips Motor connection X105	
	Order code	VPE	Order code	VPE
		Piece		Piece
i510-C0.25/230-1	EZA EVE032	10	EZA EVE038	10
i510-C0.37/230-1				
i510-C0.55/230-1				
i510-C0.75/230-1				
i510-C1.1/230-1	EZA EVE033	10		
i510-C1.5/230-1				
i510-C2.2/230-1				
i510-C0.25/230-2	EZA EVE034	10		
i510-C0.37/230-2				
i510-C0.55/230-2				
i510-C0.75/230-2				
i510-C1.1/230-2	EZA EVE035	10		
i510-C1.5/230-2				
i510-C2.2/230-2				
i510-C0.37/400-3	EZA EVE036	10		
i510-C0.55/400-3				
i510-C0.75/400-3				
i510-C1.1/400-3				
i510-C1.5/400-3				
i510-C2.2/400-3				

Terminal strips	Order code	VPE
		Piece
Relay X9	EZA EVE030	10

Terminal strips	Order code	VPE
		Piece
CANopen / Modbus X216	EZA EVE042	10



Mounting/ installation

More data and information for the mechanical and electrical installation can be found here:

- [Control cabinet structure](#) 18
- [EMC-compliant installation](#) 20
- [Standards and operating conditions](#) 33
- [Dimensions](#) 52



The scope of supply of the inverter comprises mounting instructions. They describe technical data and information on mechanical and electrical installation.

Mounting position

- Vertical alignment - all mains connections are at the top and the motor connections at the bottom.

Free spaces

- Maintain the specified free spaces above and below to the other installations.

Mechanical installation

- The mounting location and material must ensure a durable mechanical connection.
- Do not mount onto DIN rails!
- In case of continuous vibrations or shocks use vibration dampers.

How to mount the inverters onto the mounting plate

1. Prepare mounting plate with corresponding threaded holes and equip them with screws and, if required, washers.
 - a) Use screw and washer assemblies or hexagon socket screws with washers.
 - b) Do not yet tighten the screws.
2. Mount the inverter on the prepared mounting plate via keyhole suspension.
3. Only tighten the screws hand-tight.
4. If required, pre-assemble further units.
5. Adjust the units.
6. Screw the units onto the mounting plate.

The inverters are ready for wiring.

Measures for cooling during operation

- Ensure unimpeded ventilation of cooling air and outlet of exhaust air.
- If the cooling air is polluted (fluff, (conductive) dust, soot, aggressive gases), take adequate countermeasures.
 - Install filters.
 - Arrange for regular cleaning of the filters.
- If required, implement a separate air guide.

Screw and washer assemblies or hexagon socket screws with washers are recommended..

M5 x \geq 10 mm for devices up to and including 2.2 kW



Detecting and eliminating EMC interferences

Trouble	Cause	Remedy
Interferences of analog setpoints of your own or other devices and measuring systems	Unshielded motor cable has been used	Use shielded motor cable
	Shield contact is not extensive enough	Carry out optimal shielding as specified
	Shield of the motor cable is interrupted, e. g. by terminal strips, switches etc.	<ul style="list-style-type: none"> Separate components from other component parts with a minimum distance of 100 mm Use motor chokes or motor filters
	Additional unshielded cables inside the motor cable have been installed, e. g. for motor temperature monitoring	Install and shield additional cables separately
	Too long and unshielded cable ends of the motor cable	Shorten unshielded cable ends to maximally 40 mm
Conducted interference level is exceeded on the supply side	Terminal strips for the motor cable are directly located next to the mains terminals	Spatially separate the terminal strips for the motor cable from mains terminals and other control terminals with a minimum distance of 100 mm
	Mounting plate varnished	Optimise PE connection: <ul style="list-style-type: none"> Remove varnish Use zinc-coated mounting plate
	HF short circuit	Check cable routing

A good shield connection at the transitions of the different areas reduce possible interferences caused by problems with the EMC.

Example of an EMC-compliant cable gland

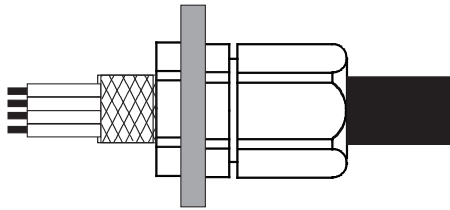

Fig. 2: EMC cable gland with a high degree of protection

Mounting/ installation

Electrical installation
Important notes



Electrical installation

Important notes

DANGER!

Dangerous electrical voltage

Depending on the device, all power connections may be live up to 3 minutes after switching off the supply.

Possible consequences: Death or severe injuries when touching the power terminals.

- ▶ Wait for at least 3 minutes before you start working on the power terminals.
 - ▶ Make sure that all power terminals are deenergised.
-

DANGER!

Dangerous electrical voltage

The leakage current against earth (PE) is $> 3.5 \text{ mA AC}$ or $> 10 \text{ mA DC}$.

Possible consequences: Death or severe injuries when touching the device in the event of an error.

- ▶ Implement the measures required in EN 61800-5-1, especially:
 - ▶ Fixed installation
 - ▶ The PE connection must comply with the standards (PE conductor diameter $\geq 10 \text{ mm}^2$ or use a double PE conductor)
-

NOTICE

No device protection against too high mains voltage

The mains input is not fused internally.

Possible consequences: Destruction of the device at too high mains voltage.

- ▶ Please observe the maximum permissible mains voltage.
 - ▶ Fuse the device professionally on the supply side against mains fluctuations and voltage peaks.
-

DANGER!

Use of the inverter on a phase earthed mains with a rated mains voltage $\geq 400 \text{ V}$

The protection against accidental contact is not ensured without external measures.

- ▶ If protection against accidental contact according to EN 61800-5-1 is required for the control terminals of the inverters and the connections of the plugged device modules, ...
 - ▶ an additional basic insulation has to be provided.
 - ▶ the components to be connected have to come with a second basic insulation.
-



i NOTICE

Overvoltage at devices with 230-V mains connection

An impermissible overvoltage may occur if the central supply of the N conductor is interrupted if the devices are connected to a TN three-phase system.

Possible consequences: Destruction of the device

- ▶ Provide for the use of isolating transformers.

i NOTICE

The product contains electrostatic sensitive devices.

Possible consequences: Destruction of the device

- ▶ Before working in the connection area, the staff must ensure to be free of electrostatic charge.

i NOTICE

Pluggable terminal strips or plug connections

Plugging or removing the terminal strips or plug connections during operation may cause high voltages and arcing.

Possible consequences: Damage of the devices

- ▶ Switch off device.
- ▶ Only plug or remove the terminal strips or plug connections in deenergised status.

i NOTICE

Use of mains filters and RFI filters in IT systems

Mains filters and RFI filters from Lenze contain components that are interconnected against PE.

Possible consequences: The filters may be destroyed when an earth fault occurs.

Possible consequences: Monitoring of the IT system may be triggered.

- ▶ Do not use mains filters and RFI filters from Lenze in IT systems.
- ▶ Before using the inverter in the IT system, remove the IT screws.

i NOTICE

Overvoltage at components

In case of an earth fault in IT systems, intolerable overvoltages may occur in the plant.

Possible consequences: Destruction of the device.

- ▶ Before using the inverter in the IT system, the contact screws must be removed.
- ▶ Positions and number of the contact screws depend on the device.



Ensure a trouble-free operation:

Carry out the total wiring so that the separation of the separate potential areas is preserved.

Mounting/ installation

Electrical installation
Important notes



When implementing machines and systems for the use in the UL/CSA scope, you have to observe especially issued notes.

These notes and further information on the UL/CSA subject are summarised in separated documents.



You have to install the devices into housings (e. g. control cabinets) to comply with valid regulations.

Stickers with warning notes must be displayed prominently and close to the device.



Mains connection

The following should be considered for the mains connection of inverters:

Single inverters are either directly connected to the **AC system** or via upstream filters. RFI filters are already integrated in many inverters. Depending on the requirements, mains chokes or mains filters can be used.

Inverter groups are connected to the **DC system** with the DC bus. For this purpose, the inverters have to be provided with a connection for the DC bus, e. g. terminals +UG/-UG.

This enables the energy exchange in phases with operation in generator and motor mode of several drives in the network.

The DC system can be provided by power supply modules (AC/DC converters) or inverters with a power reserve.

The technical data informs about the possible applications in the given groups. In the dimensioning, data and further notes have to be observed.

Mounting/ installation

Electrical installation
Mains connection



1-phase mains connection 230/240 V

Connection plan

The wiring diagram is valid for I5xAExxxB inverters.

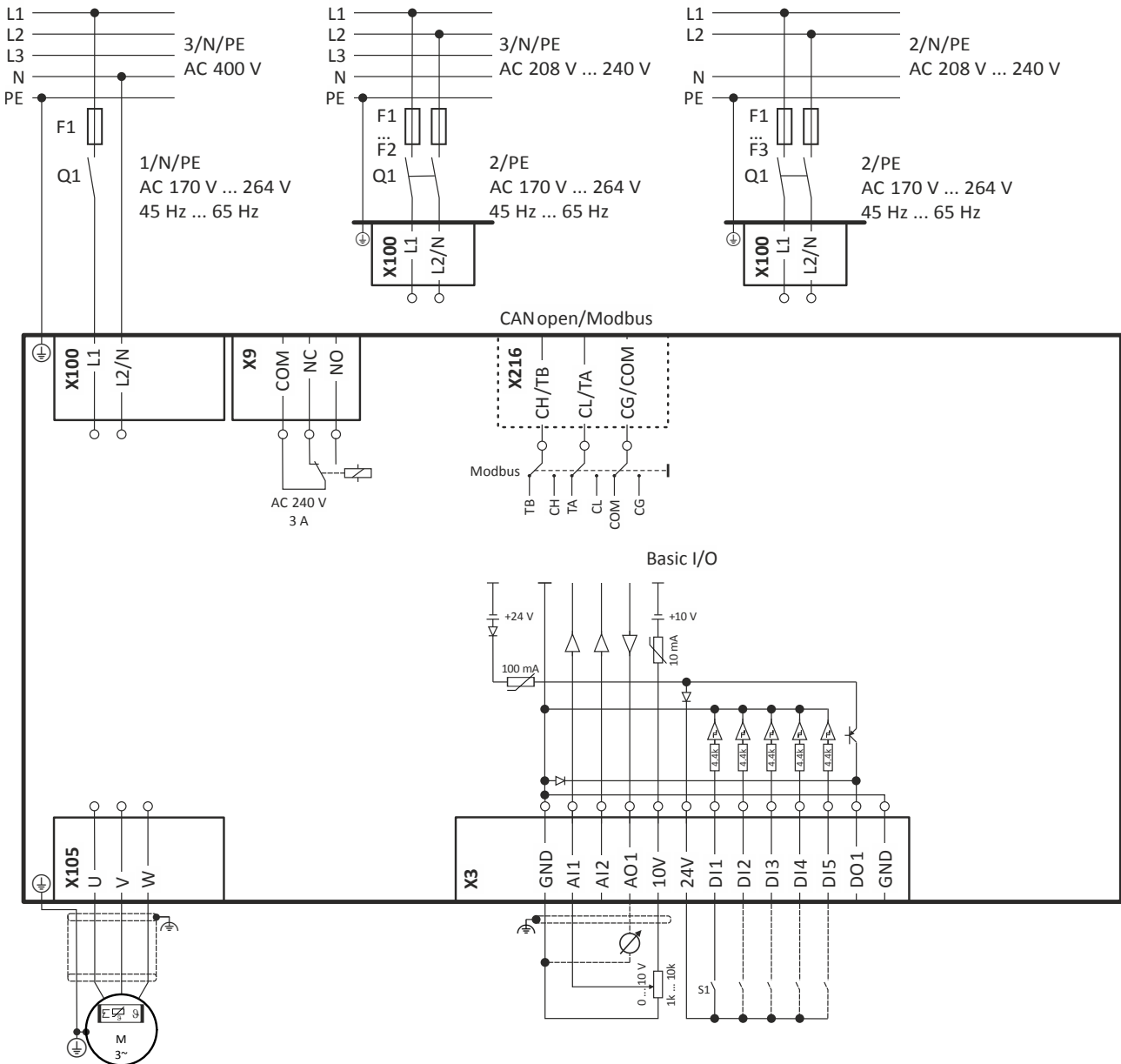

Fig. 3: Wiring example

S1 Run/Stop
Fx Fuses

Q1 Mains contactor
--- Dashed line = options



Mounting/ installation

Electrical installation
Mains connection

1/3-phase mains connection 230/240 V

Connection plan

The wiring diagram is valid for I5xAExxxD inverters.

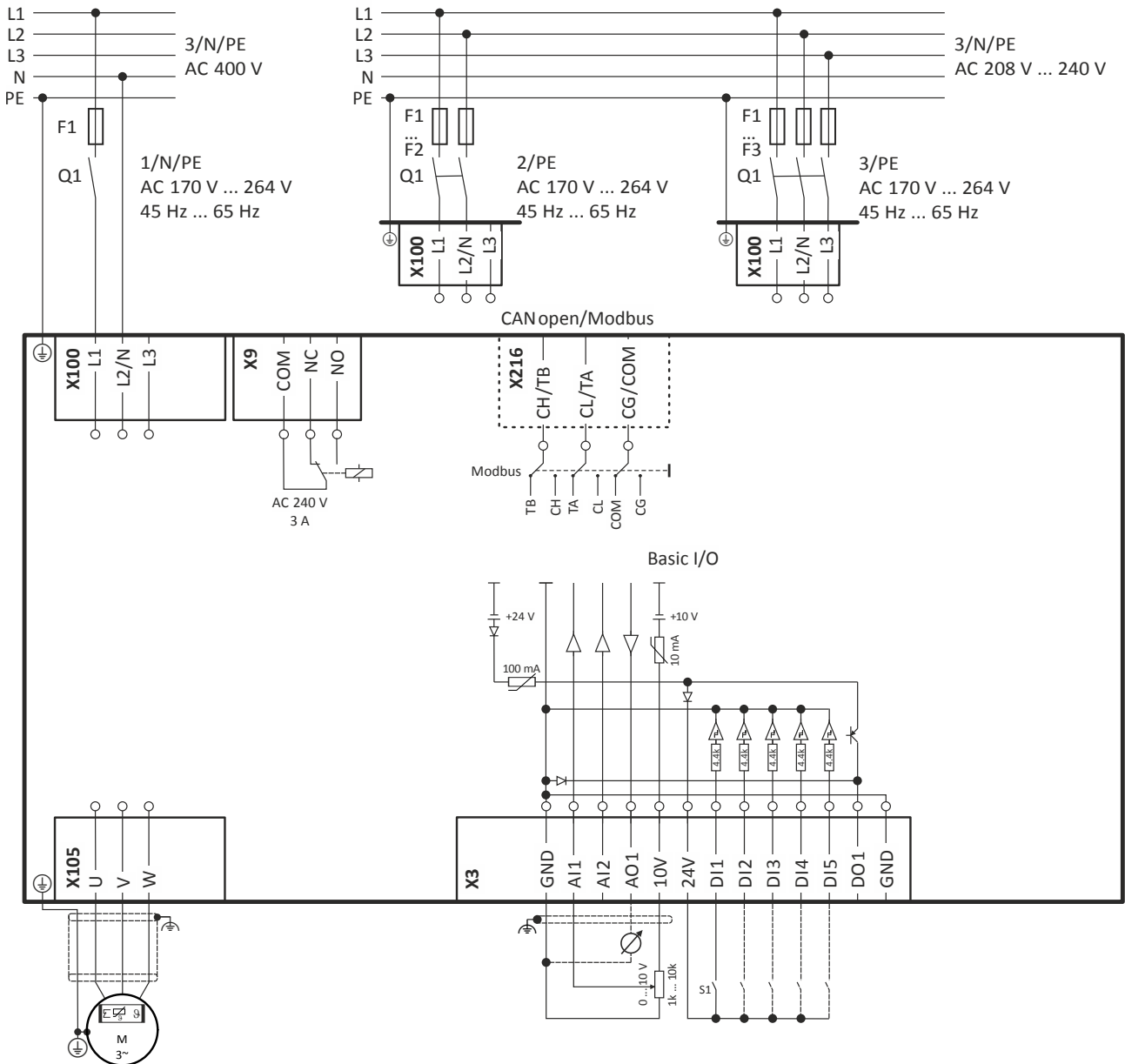

Fig. 4: Wiring example

S1 Run/Stop
Fx Fuses

Q1 Mains contactor
--- Dashed line = options

Mounting/ installation

Electrical installation
Mains connection



3-phase mains connection 400 V

Connection plan

The wiring diagram is valid for I5xAExxxF inverters.

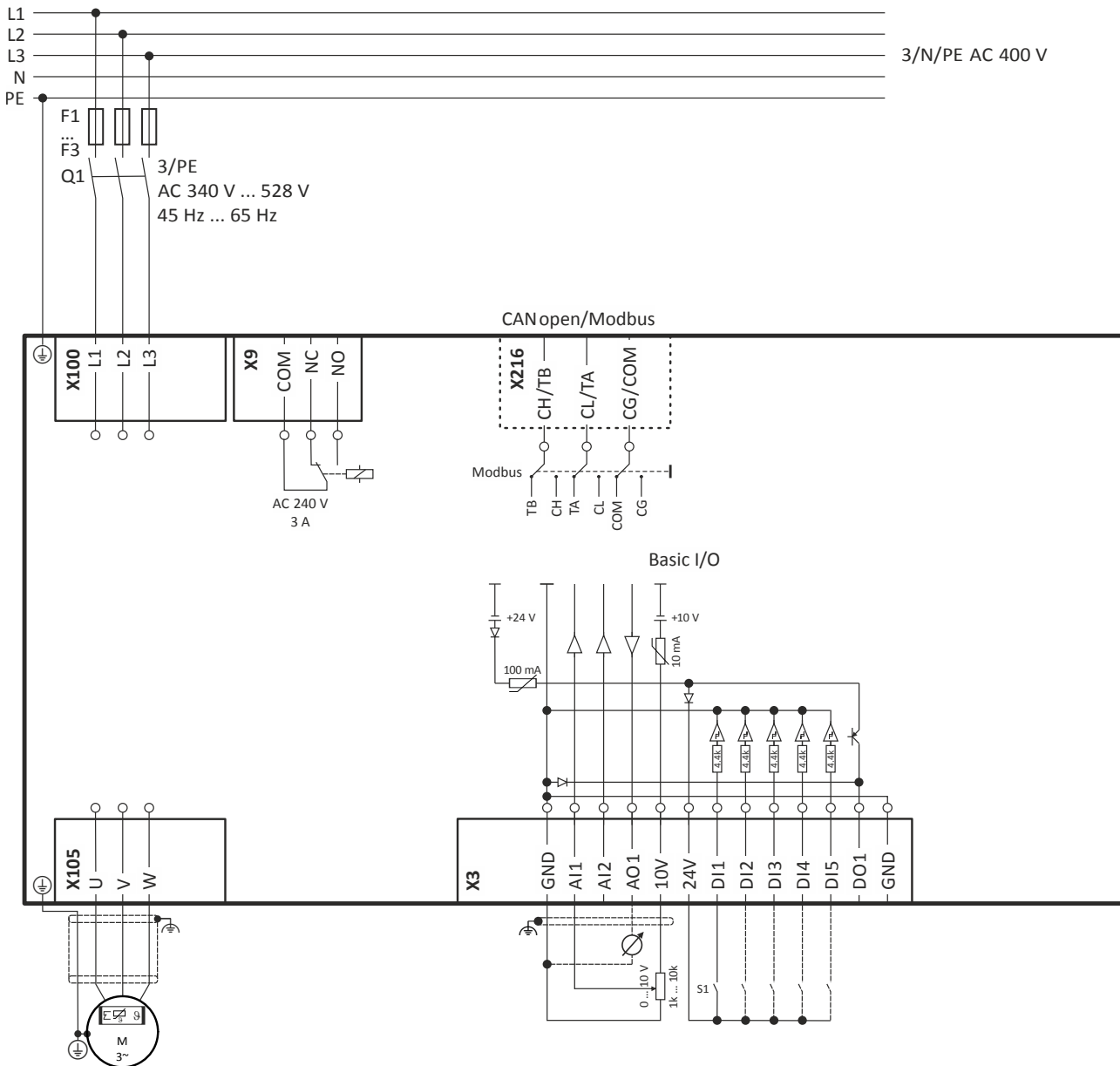

Fig. 5: Wiring example

S1 Run/Stop
Fx Fuses

Q1 Mains contactor
--- Dashed line = options



3-phase mains connection 480 V

Connection plan

The wiring diagram is valid for I5xAExxxF inverters.

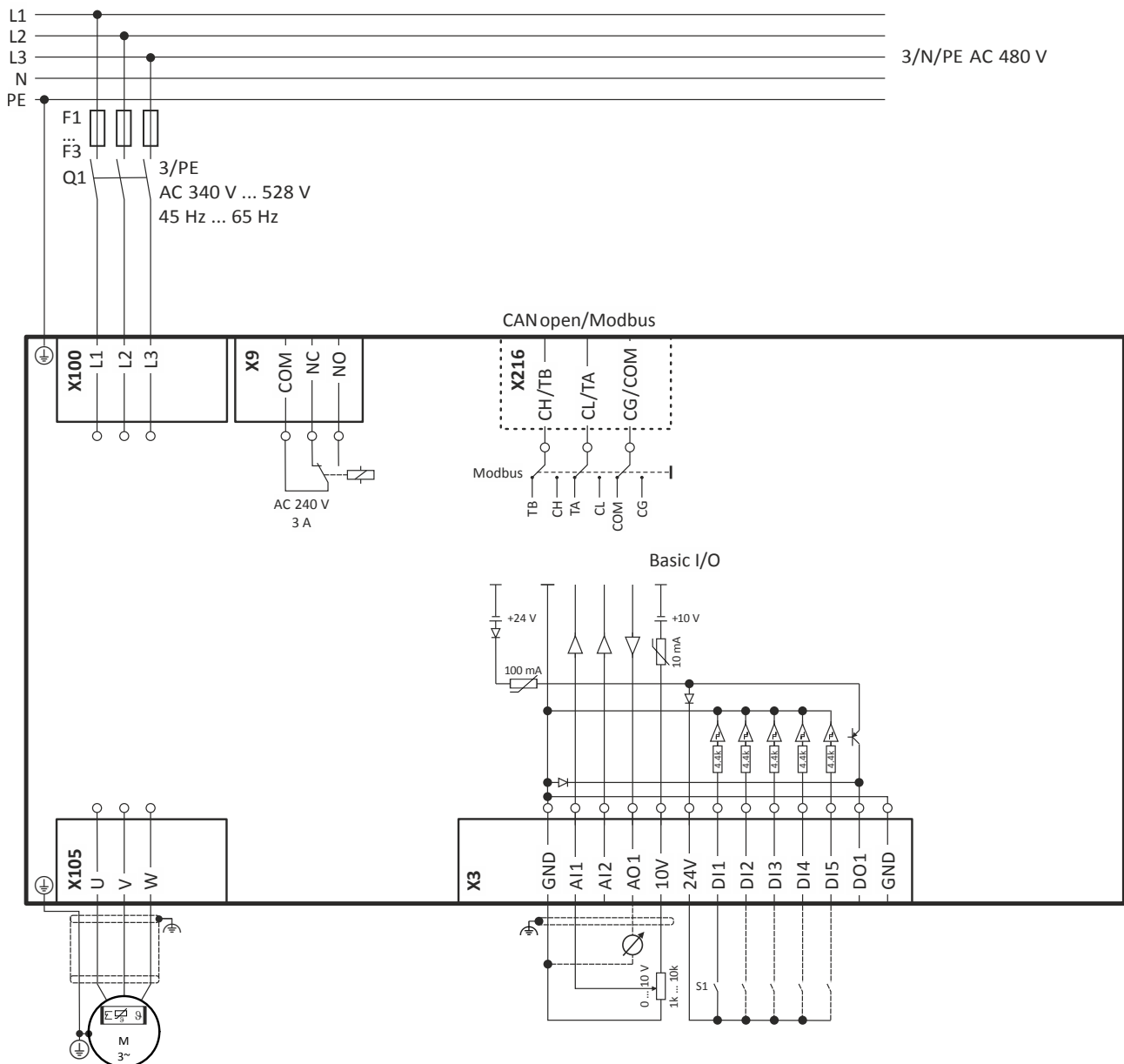

Fig. 6: Wiring example

S1 Run/Stop
Fx Fuses

Q1 Mains contactor
--- Dashed line = options

Mounting/ installation

Electrical installation
Motor connection



Motor connection

A good shield connection and short cable lengths reduce possible interferences caused by problems with the EMC.

Example for preparing the EMC-compliant wiring or the motor cable

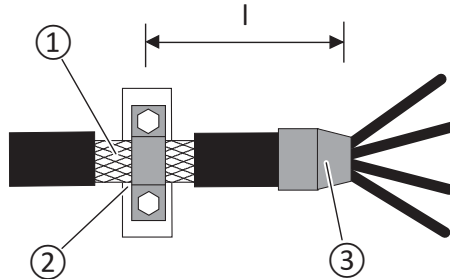

Fig. 7: Shield connection

- ① Braid
- ② large surface contacting of the braid
- ③ Heat-shrinkable tube
- l maximally 500 mm

Switching in the motor cable



Switching on the motor side of the inverter is permissible:

For safety shutdown (emergency stop).

In case several motors are driven by one inverter (only in V/f operating mode).

Please note the following:

The switching elements on the motor side must be dimensioned for with the maximum occurring load.

Control connections



In order to achieve an optimum shielding effect (in case of very long cables, with high interference), one shield end of analog input and output cables can be connected to PE potential via a capacitor (e. g. 10 nF/250 V).

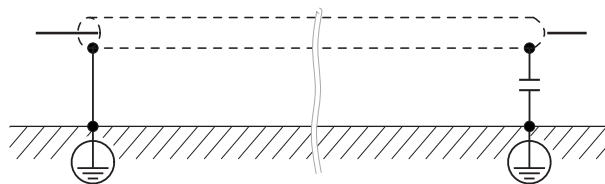



Purchase order

Notes on ordering

The inverters are supplied as complete devices. A control unit with basic I/O is integrated.

As the control unit cannot be extended, the inverter i510 is available in two versions:

- With CANopen/Modbus, switchable.
- Without network.

Kompletter Inverter



Purchase order

Order code



Order code

Delivery as complete inverter

Order data: Order code of the complete device.

Order example

Description of the component	Order code
Complete inverter	i51AE175F10010001S
3-phase mains connection 400 V	
Power 0.75 kW (i510-C0.75/400-3)	
Without safety engineering (not available for i510)	
Default setting of parameters: EU region (50-Hz systems)	
Basic I/O with CANopen/Modbus	

Inverter i510

Power		Inverter	Order code				
kW	HP						
1-phase mains connection 230 V				0	01		
0.25	0.33	i510-C0.25/230-1	i51AE125B1				
0.37	0.5	i510-C0.37/230-1	i51AE137B1				
0.55	0.75	i510-C0.55/230-1	i51AE155B1				
0.75	1	i510-C0.75/230-1	i51AE175B1				
1.1	1.5	i510-C1.1/230-1	i51AE211B1				
1.5	2	i510-C1.5/230-1	i51AE215B1				
2.2	3	i510-C2.2/230-1	i51AE222B1				
1/3-phase mains connection 230 V							
0.25	0.33	i510-C0.25/230-2	i51AE125D1				
0.37	0.5	i510-C0.37/230-2	i51AE137D1				
0.55	0.75	i510-C0.55/230-2	i51AE155D1				
0.75	1	i510-C0.75/230-2	i51AE175D1				
1.1	1.5	i510-C1.1/230-2	i51AE211D1				
1.5	2	i510-C1.5/230-2	i51AE215D1				
2.2	3	i510-C2.2/230-2	i51AE222D1				
3-phase mains connection 400 V							
0.37	0.5	i510-C0.37/400-3	i51AE137F1				
0.55	0.75	i510-C0.55/400-3	i51AE155F1				
0.75	1	i510-C0.75/400-3	i51AE175F1				
1.1	1.5	i510-C1.1/400-3	i51AE211F1				
1.5	2	i510-C1.5/400-3	i51AE215F1				
2.2	3	i510-C2.2/400-3	i51AE222F1				
Delivery status							
Default setting of parameters: EU region (50-Hz systems)							0
Default setting of parameters: US region (60-Hz systems)							1
Control unit type							
Basic I/O without network							000S
Basic I/O with CANopen/Modbus							001S



Appendix

Good to know

Approvals/directives

CCC	China Compulsory Certification documents the compliance with the legal product safety requirements of the PR of China - GB standards.
c _{CSA} _{US}	CSA certificate, tested according to US and Canada standards
CE	Communauté Européenne documents the declaration of the manufacturer that EC Directives are complied with.
CEL	China Energy Label documents the compliance with the legal energy efficiency requirements for motors, tested according to PR of China standards
CSA	Canadian Standards Association CSA certificate, tested according to Canada standards
UL ^{Energy} _{US CA}	Energy Verified Certificate Determining the energy efficiency according to CSA C390 for products within the scope of energy efficiency requirements in the USA and Canada
c _{UL} _{US}	UL certificate for products, tested according to US and Canada standards
c _{UR} _{US}	UL certificate for components, tested according to US and Canada standards
EAC	Customs union Russia / Belarus / Kazakhstan certificate documents the declaration of the manufacturer that the specifications for the Eurasian conformity (EAC) required for placing electronic and electromechanical products on the market of the entire territory of the Customs Union (Russia, Belarus, Kazakhstan) are complied with.
UL	Underwriters Laboratory Listed Product
UR	UL certificate for components, tested according to US standards

Appendix

Good to know
Operating modes of the motor



Operating modes of the motor

Operating modes S1 ... S10 as specified by EN 60034-1 describe the basic stress of an electrical machine.

In continuous operation a motor reaches its permissible temperature limit if it outputs the rated power dimensioned for continuous operation. However, if the motor is only subjected to load for a short time, the power output by the motor may be greater without the motor reaching its permissible temperature limit. This behaviour is referred to as overload capacity.

Depending on the duration of the load and the resulting temperature rise, the required motor can be selected reduced by the overload capacity.

The most important operating modes

Continuous operation S1	Short-time operation S2
<p>Operation with a constant load until the motor reaches the thermal steady state. The motor may be actuated continuously with its rated power.</p>	<p>Operation with constant load; however, the motor does not reach the thermal steady state. During the following standstill, the motor winding cools down to the ambient temperature again. The increase in power depends on the load duration.</p>
Intermittent operation S3	Non-intermittent periodic operation S6
<p>Sequence of identical duty cycles comprising operation with a constant load and subsequent standstill. Start-up and braking processes do not have an impact on the winding temperature. The steady-state is not reached. The guide values apply to a cycle duration of 10 minutes. The power increase depends on the cycle duration and on the load period/downtime ratio.</p>	<p>Sequence of identical duty cycles comprising operation with a constant load and subsequent no-load operation. The motor cools down during the no-load phase. Start-up and braking processes do not have an impact on the winding temperature. The steady-state is not reached. The guide values apply to a cycle duration of 10 minutes. The power increase depends on the cycle duration and on the load period/idle time ratio.</p>

P Power
t Time
 t_L Idle time
 ϑ Temperature

P_V Power loss
 t_B Load period
 t_S Cycle duration



Motor control types

The inverter provides various motor control types.

Linear V/f characteristic control

The output voltage is increased proportionately to the output frequency.

In case of low output frequencies, the motor voltage can be increased to ensure a minimum current for the breakaway torque. In the field weakening range, the output voltage of the inverter is constant (mains voltage) and the frequency can be further increased depending on the load. The maximum torque of the motor is reduced squared to the frequency increase. the maximum output power of the motor being constant.

Application areas are for instance: Single drives with constant load.

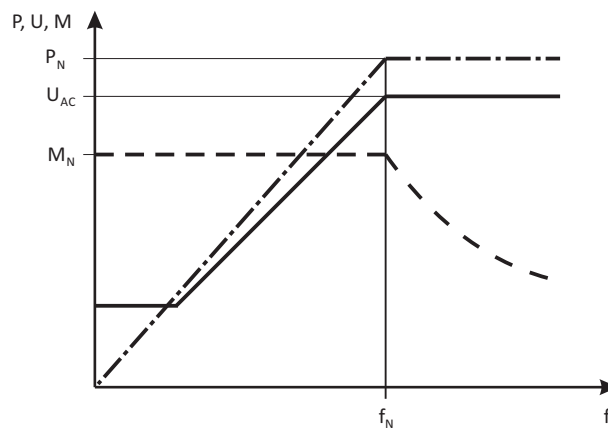

P	Power	M_{rated}	Rated torque
V	Voltage	f_{rated}	Rated frequency
M	Torque	M_{rated}	Rated torque
f	Frequency	f_{rated}	Rated frequency

Square-law V/f characteristic control

The output voltage is increased squaredly to the output frequency.

In case of low output frequencies, the motor voltage can be increased to ensure a minimum current for the breakaway torque. In the field weakening range, the output voltage of the inverter is constant (mains voltage) and the frequency can be further increased depending on the load. The maximum torque of the motor is reduced squaredly to the frequency increase. the maximum output power of the motor being constant.

Application areas are for instance:

- Pumps
- Fans
- Fan

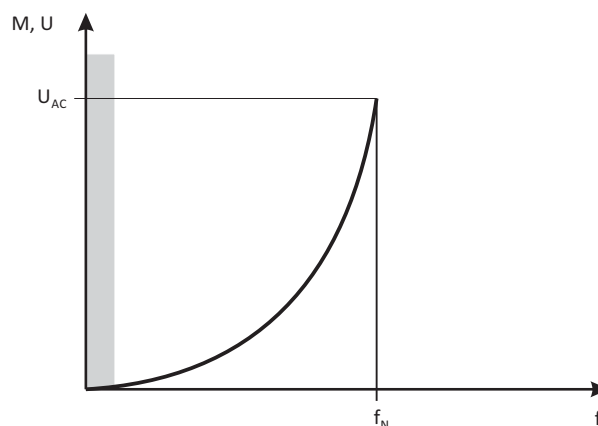



V	Voltage	U_{AC}	Mains voltage
f	Frequency	f_{rated}	Rated frequency
M	Torque		

VFCeco

The VFCeco mode has a special effect in the partial load operational range. Usually, three-phase AC motors are supplied there with a higher magnetising current than required by the operating conditions. The VFCeco mode reduces the losses in the partial load operational range so that savings up to 30 % are possible.

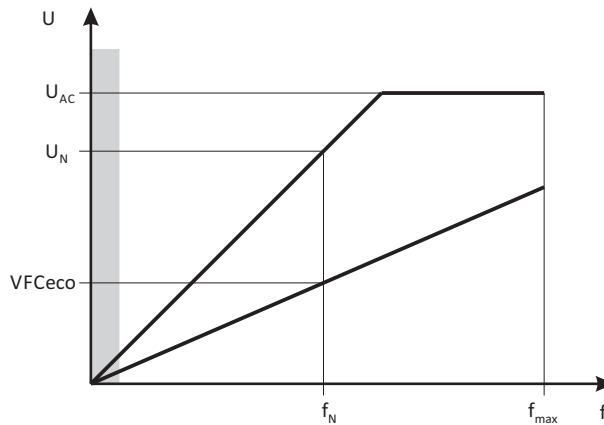

V	Voltage	f	Frequency
U_{AC}	Mains voltage	f_{rated}	Rated frequency
U_{rated}	Rated voltage	f_{max}	Max. frequency

Sensorless vector control (SLVC)

In vector control, an inverted voltage model is used for calculation. The parameters are detected via a parameter identification. The inverter determines the angle between current and voltage. This imposes a current on the motor”.

Compared to the V/f characteristic control, the vector control serves to achieve improved drive characteristics thanks to:

- higher torque throughout the entire speed range
- higher speed accuracy and higher concentricity factor
- higher efficiency

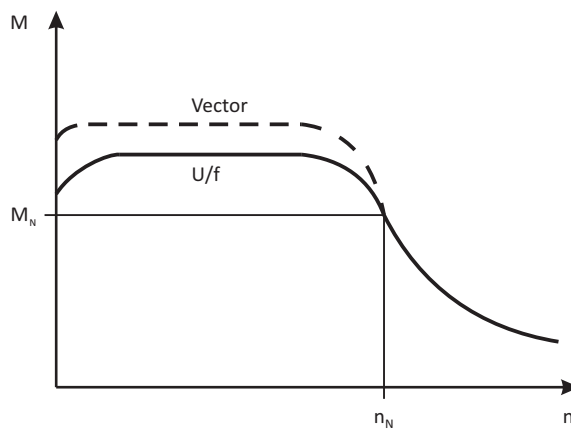

M	Torque	M_{rated}	Rated torque
n	Speed	n_{rated}	Rated speed

Application areas are for instance:

- Single drives with changing loads



- Single drives with high starting duty
- Sensorless speed control of three-phase AC motors

Switching frequencies

On an inverter, the term "switching frequency" is understood to mean the frequency with which the input and outputs of the output module (inverter) are switched. On an inverter, the switching frequency can generally be set to values between 2 and 16 kHz, whereby the selection is based on the respective power output

As switching the modules cause heat losses, the inverter can provide higher output currents at low switching frequencies than at high frequencies. Additionally, it is distinguished between the operation at a permanently set switching frequency and a variably set switching frequency. Here, the switching frequency is automatically reduced as a function of the device utilisation.

At a higher switching frequency, the noise generation is less.

Features	Versions
Switching frequencies	<ul style="list-style-type: none"> • 2 kHz • 4 kHz • 8 kHz • 16 kHz • variable (automatic adjustment)

Enclosures

The degree of protection indicates the suitability of a motor for specific ambient conditions with regard to humidity as well as the protection against contact and the ingress of foreign particles. The degrees of protection are classified by EN 60529.

The first code number after the code letters IP indicates the protection against the ingress of foreign particles and dust. The second code number refers to the protection against the ingress of humidity.

Code number 1	Degree of protection	Code number 2	Degree of protection
0	No protection	0	No protection
1	Protection against the ingress of foreign particles d > 50 mm. No protection in case of deliberate access.	1	Protection against vertically dripping water (dripping water).
2	Protection against medium-sized foreign particles, d > 12 mm, keeping away fingers or similar.	2	Protection against diagonally falling water (dripping water), 15 ° compared to normal service position.
3	Protection against small foreign particles d > 2.5 mm. Keeping away tools, wires or similar.	3	Protection against spraying water, up to 60 ° to the vertical
4	Protection against granular foreign particles, d > 1 mm, keeping away tools, wire or similar.	4	Protection against spraying water from all directions.
5	Protection against dust deposits (dust-protected), complete protection against contact.	5	Protection against water jets from all directions.
6	Protection against the ingress of dust (dust-proof), complete protection against contact.	6	Protection against choppy seas or heavy water jets (flood protection).

🏢 Lenze Drives GmbH
Postfach 10 13 52, D-31763 Hameln
Breslauer Straße 3, D-32699 Extertal
Germany
HR Lemgo B 6478

☎ +49 5154 82-0
📠 +49 5154 82-2800
@ lenze@lenze.com
🌐 www.lenze.com

✂ Lenze Service GmbH
Breslauer Straße 3, D-32699 Extertal
Germany

☎ 0080002446877 (24 h helpline)
📠 +49 5154 82-1112
@ service.de@lenze.com

TD 20160725

