

BTS Series Ultra-compact Amplifier Built-in Type

Ultra-compact, Amplifier Built-in Type

Feature

- Minimizes installation space with ultra-compact size
- Size: Through-beam type (W7.2×H18.6×L9.5mm)
Retroreflective type, convergent reflective type (W7.2×H24.6×L10.8mm)
- Sensing min. \varnothing 0.15mm of sensing target (Convergent reflective type)
- 1m of Max. sensing distance (Through-beam type)
- Check the sensing spot position due to visible light source. It helps to decide the installation place.
- Adopts clear operation indicator (red) and stability indicator (green). They can help to check the operation status instantly at the narrow space.
- Protection degree IP67 (IEC standard)

⚠ Please read "Caution for your safety" in operation manual before using.

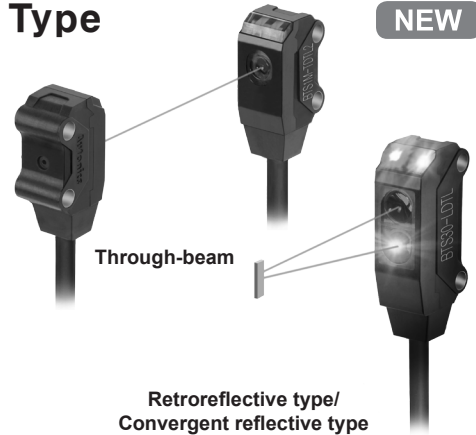

Specifications

Model	NPN open collector output	BTS1M-TDTL	BTS1M-TDTD	BTS200-MDTL	BTS200-MDTD	BTS30-LDTL	BTS30-LDTD	BTS15-LDTL	BTS15-LDTD
	PNP open collector output	BTS1M-TDTL-P	BTS1M-TDTD-P	BTS200-MDTL-P	BTS200-MDTD-P	BTS30-LDTL-P	BTS30-LDTD-P	BTS15-LDTL-P	BTS15-LDTD-P
Sensing type	Through-beam type			Retroreflective type		Convergent reflective type			
Sensing distance	1m			10 to 200mm (MS-6)		5 to 30mm (non-glossy white paper 50×50mm)		5 to 15mm (non-glossy white paper 50×50mm)	
Sensing target	Opaque material of max. \varnothing 2mm			Opaque material of max. \varnothing 27mm		Opaque material, Translucent materials			
Min. sensing target	Opaque material of \varnothing 2mm			Opaque material of \varnothing 2mm ^{*1} (sensing distance 100mm)		\varnothing 0.15mm (sensing distance 10mm)			
Hysteresis distance	—			—		Max. 15% of maximum sensing distance			
Response time	Max. 1ms								
Power supply	12-24VDC \pm 10% (ripple P-P: max. 10%)								
Current consumption	Max. 20mA (in case of through-beam type, this value is for each emitter and receiver)								
Light source	Red LED (650nm)								
Operation mode	Light ON	Dark ON	Light ON	Dark ON	Light ON	Dark ON	Light ON	Dark ON	Dark ON
Control output	<NPN or PNP open collector output> ·Load voltage: max. 26.4VDC ·Load current: max. 50mA ·Residual voltage: max. 1V (NPN), max. 2V (PNP)								
Protection circuit	Power reverse polarity protection, Output short-circuit over current protection								
Indicator	Operation indicator: Red, Stability indicator: Green								
Insulation resistance	Max. 20M Ω (at 500VDC megger)								
Noise strength	\pm 240V the square wave noise (pulse 1 μ s)								
Dielectric strength	1,000VAC 50/60Hz for 1 min.								
Vibration	1.5mm amplitude at frequency of 10 to 55Hz (for 1 min.) in each X, Y, Z direction for 2 hours								
Shock	500m/s ² (approx. 50G) in each X, Y, Z direction for 3 times								
Environment	Ambient illumination	Sunlight: max. 10,000lx, Incandescent lamp: max. 3,000lx (receiver illumination)							
	Ambient temperature	-20 to 55°C, storage: -30 to 70°C							
	Ambient humidity	35 to 85%RH, storage: 35 to 85%RH							
Protection structure	IP67 (IEC standard)								
Material	Case: PBT, Sensing part: PMMA, Bracket: SUS304, Bolt: SWCH10A								
Cable	\varnothing 2.5mm, 3-wire, length: 2m (emitter of through-beam type: \varnothing 2.5mm, 2-wire, length: 2m) (AWG 28, core wire diameter: 0.08mm, no. of core wire: 19, insulator diameter: \varnothing 0.9mm)								
Accessory	Bracket A×2EA, Sub-bracket for through-beam type×2EA, M2 bolt×4EA			Reflector (MS-6), Bracket A, Sub-bracket for reflective type, M2 bolt×2EA		Bracket A, Sub-bracket for reflective type, M2 bolt×2EA			
Approval	CE								
Weight ^{*2}	Approx. 97g (approx. 45g)			Approx. 70g (approx. 25g)		Approx. 68g (approx. 25g)			

*1: It will vary by the installation environment and sensing conditions.

Please refer to the '© Conditions of min. sensing target and installations (retroreflective type)'.

When using reflective tapes, the Reflectivity vary by the size of the tape.

Please refer to the '■ Reflectivity By Reflective Tape Model' table before using the tape.

*2: The weight includes packaging. The weight in parentheses is for unit only.

*3: The temperature or humidity mentioned in Environment indicates a non freezing or condensation environment.

(A) Photoelectric Sensors

(B) Fiber Optic Sensors

(C) Door/Area Sensors

(D) Proximity Sensors

(E) Pressure Sensors

(F) Rotary Encoders

(G) Connectors/ Sockets

(H) Temperature Controllers

(I) SSRs / Power Controllers

(J) Counters

(K) Timers

(L) Panel Meters

(M) Tacho / Speed / Pulse Meters

(N) Display Units

(O) Sensor Controllers

(P) Switching Mode Power Supplies

(Q) Stepper Motors & Drivers & Controllers

(R) Graphic/ Logic Panels

(S) Field Network Devices

(T) Software

BTS Series

■ Feature Data

◎ Through-beam

- BTS1M-TDTL / BTS1M-TDTL-P

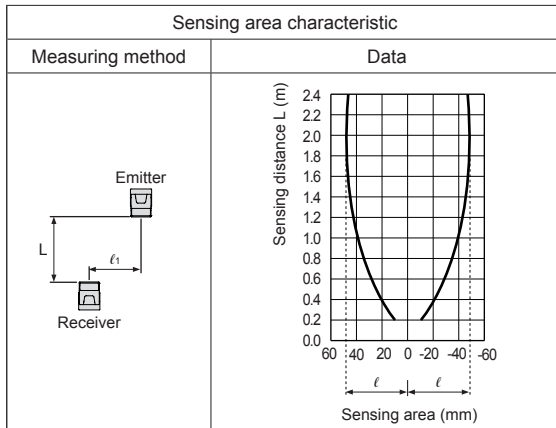

◎ Convergent reflective type

- BTS30-LDTL / BTS30-LDTL-P

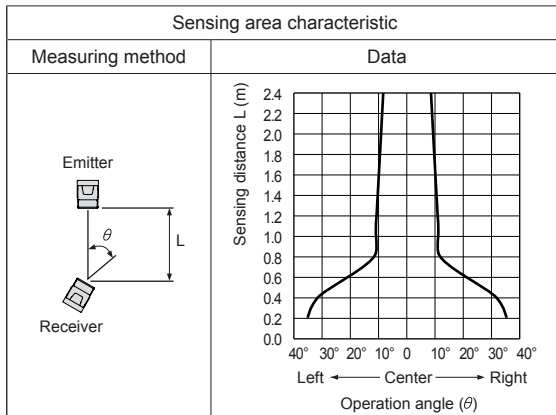
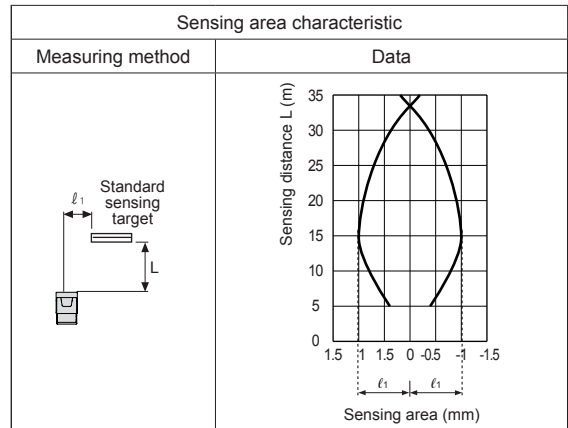

■ Connections

● Through-beam

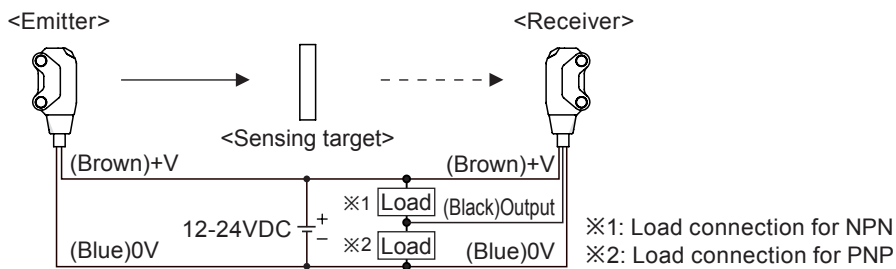

● Retroreflective type

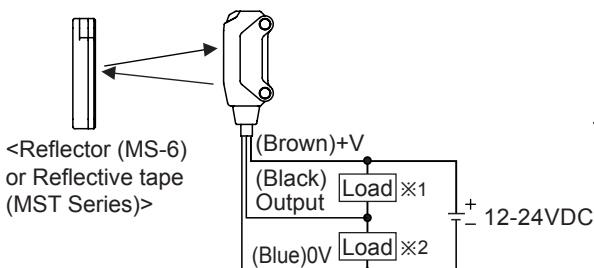

● Convergent reflective type

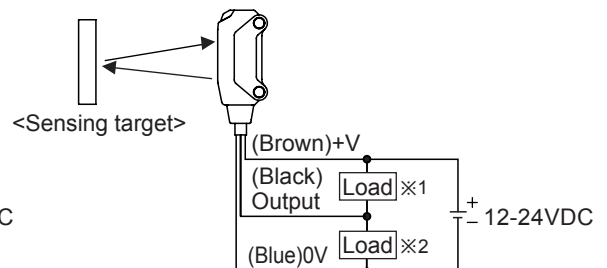

Ultra-compact Amplifier Built-in Type

Control output diagram

• NPN open collector output

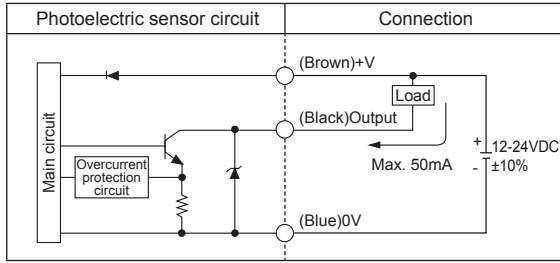

• PNP open collector output

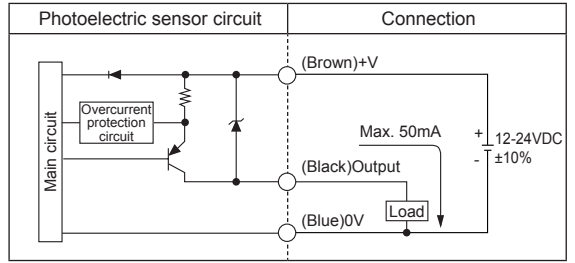

Operation Mode

Operation mode	Light ON		Dark ON	
Receiver operation	Received light		Received light	
	Interrupted light		Interrupted light	
Operation indicator (red LED)	ON		ON	
	OFF		OFF	
Transistor output	ON		ON	
	OFF		OFF	

Dimensions

• Through-beam

(unit: mm)

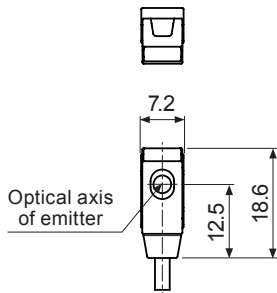

<Emitter>

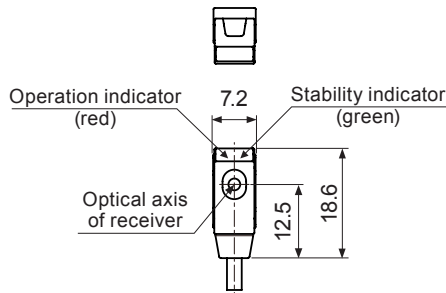

<Receiver>

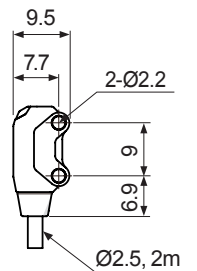

• Retroreflective type / Convergent reflective type

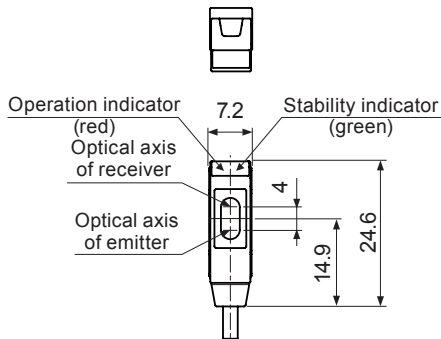

<Retroreflective type>

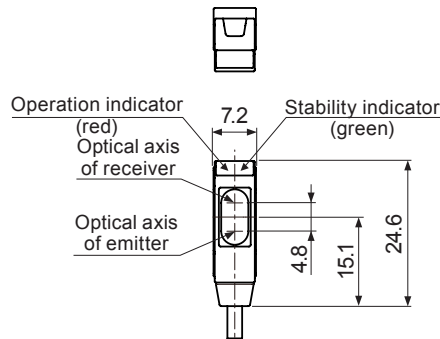

<Convergent reflective type>

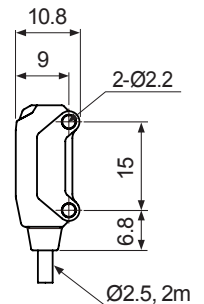

(A) Photoelectric Sensors

(B) Fiber Optic Sensors

(C) Door/Area Sensors

(D) Proximity Sensors

(E) Pressure Sensors

(F) Rotary Encoders

(G) Connectors/ Sockets

(H) Temperature Controllers

(I) SSRs / Power Controllers

(J) Counters

(K) Timers

(L) Panel Meters

(M) Tacho / Speed / Pulse Meters

(N) Display Units

(O) Sensor Controllers

(P) Switching Mode Power Supplies

(Q) Stepper Motors & Drivers & Controllers

(R) Graphic/ Logic Panels

(S) Field Network Devices

(T) Software

BTS Series

• Bracket A

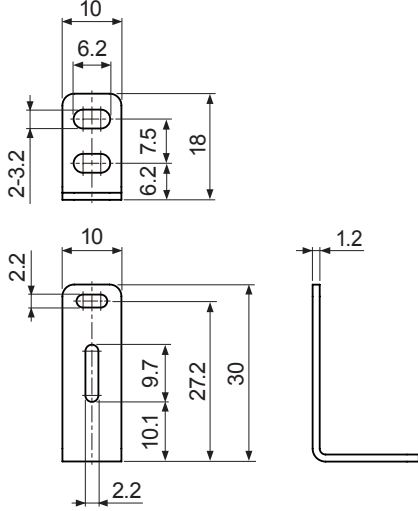

• Bracket B (sold separately)

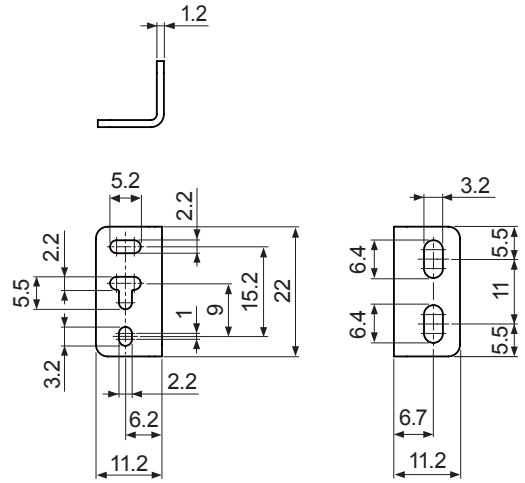

• Sub-bracket for through-beam type

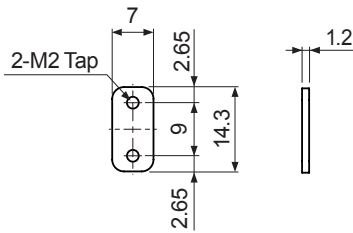

• Sub-bracket for reflective type

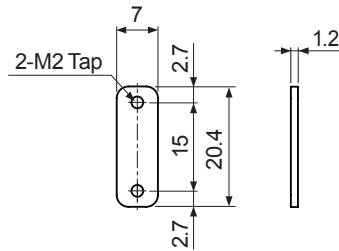

• Reflector (MS-6)

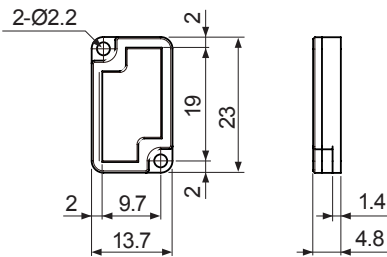

• Reflective tape (sold separately)

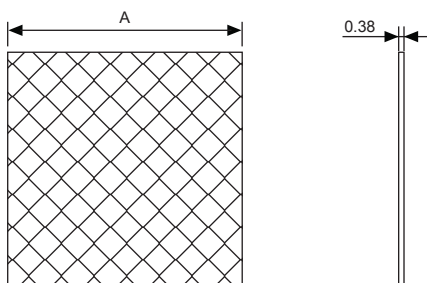

(unit: mm)

	A
MST-50-10	□50
MST-100-5	□100
MST-200-2	□200

Ultra-compact Amplifier Built-in Type

■ Operation Timing Diagram

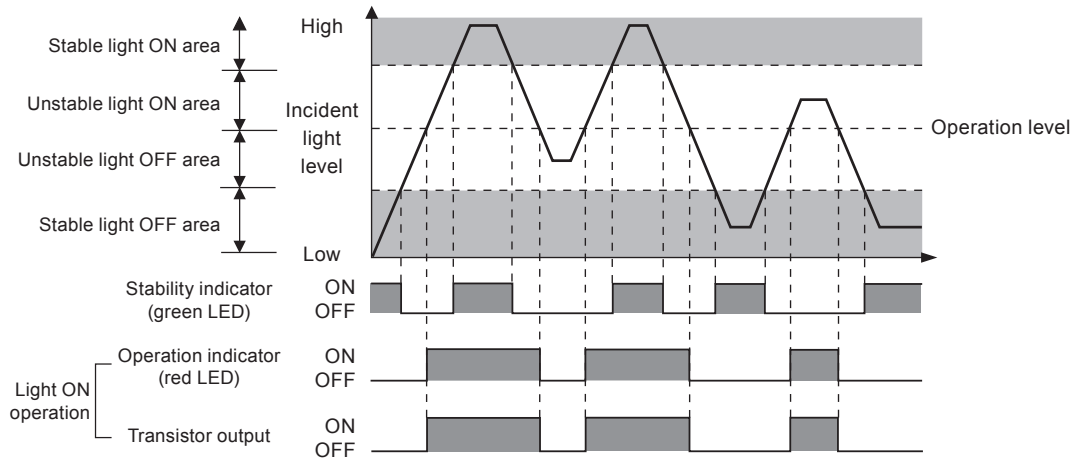

※ The waveforms of “Operation indicator” and “Transistor output” are for Light ON operation. They are reversed for Dark ON operation.

■ Mounting And Sensitivity Adjustment

◎ Installation

Use M2 bolts to install this sensor, and keep the tightening torque under 0.3N.m

※ Please use with caution, as impact against firm objects or excessive bending of cables may cause damage to the waterproof function.

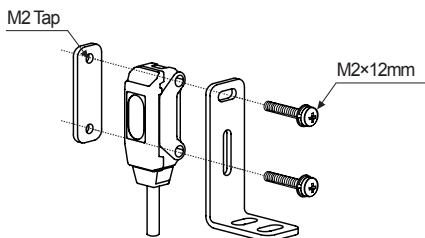

※ Cautions during installation of convergent reflective type

1) Make sure that the sensing side of this sensor is parallel to the surface of each object.

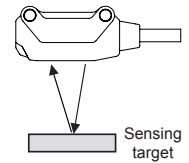

2) Make sure to install the sensor after carefully considering the moving direction of the sensing objects. Refer to the illustration below:

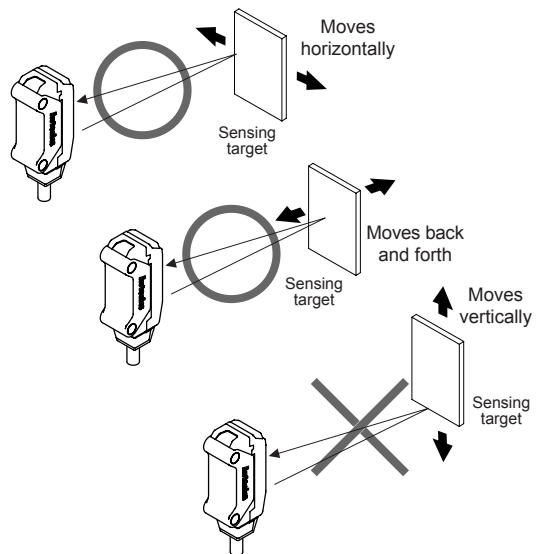

(A) Photoelectric Sensors

(B) Fiber Optic Sensors

(C) Door/Area Sensors

(D) Proximity Sensors

(E) Pressure Sensors

(F) Rotary Encoders

(G) Connectors/ Sockets

(H) Temperature Controllers

(I) SSRs / Power Controllers

(J) Counters

(K) Timers

(L) Panel Meters

(M) Tacho / Speed / Pulse Meters

(N) Display Units

(O) Sensor Controllers

(P) Switching Mode Power Supplies

(Q) Stepper Motors & Drivers & Controllers

(R) Graphic/ Logic Panels

(S) Field Network Devices

(T) Software

◎ Optical axis adjustment

● Through-beam type

Set the emitter and the receiver facing each other. Adjust the emitter or the receiver up, down, left, right and fix the unit at the center position where the stability indicator is operating.

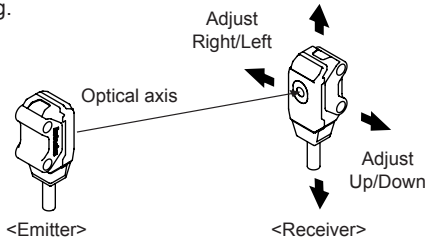

● Retroreflective type

Place the sensor and the reflector (MS-6) or reflective tape facing each other. Adjust the reflector up, down, left, right and fix the reflector at the center position where the stability indicator is operating. Make sure that the sensing side of the sensor is parallel to the surface of the reflector.

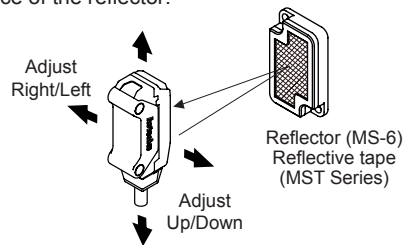

※Please use reflective tape (MST Series) for where a reflector is not installed.

● Convergent reflective type

Place the sensing target, then adjust the sensor up, down, left, right and fix the sensor at the center position where the stability indicator is operating. Make sure that the sensing side of the sensor is parallel to the surface of each object.

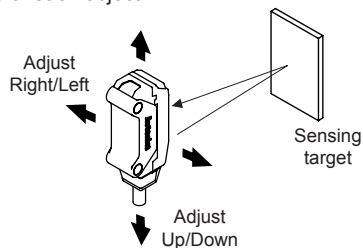

◎ Conditions of min. sensing target and installations (retroreflective type)

When installing the retroreflective photoelectric sensor, be sure to check the moving direction of sensing targets. Please refer to the [Figure 1, 2].

As the [Figure 3], please consist the center between the sensor and the reflector (MS-6) or reflective tape, and check the stable Light ON operations (operation (red)/ stability (green) indicators turn ON). Min. sensing target is detected 100mm away from the sensor (example).

[Figure 1]

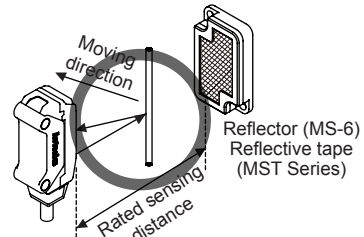

[Figure 2]

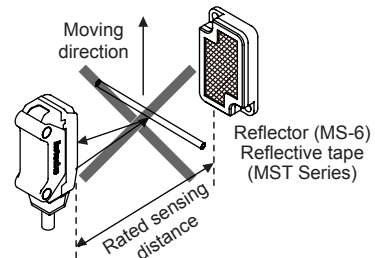

[Figure 3]

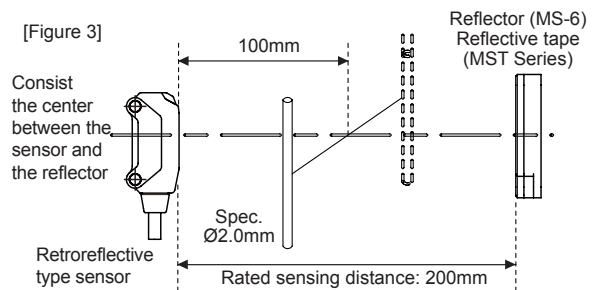

※The size of minimum sensing target will vary by the installation environment of the reflector (MS-6) and the sensing position and material of the sensing target.

■ Reflectivity By Reflective Tape Model

MST-50-10 (50×50mm)	95%
MST-100-5 (100×100mm)	100%
MST-200-2 (200×200mm)	100%

※This reflectivity is based on the reflector (MS-6).

※Reflectivity may vary depending on usage environment and installation conditions.

The sensing distance and minimum sensing target size increase as the size of the tape increases.

Please check the reflectivity before using reflective tapes.

※For using reflective tape, installation distance should be min. 20mm.