

FS Series

DIN size W48 × H48mm 8Pin plug Counter

■ Features

- Available to count from low speed to high speed
: selectable 1cps, 30cps, 2kcps, 5kcps
- Wide range of input power
: 100–240VAC 50/60Hz, 12–24VDC (Option)
- Memory retention function when the power fails
- Count Up, Count Down function
- Available to set decimal point
- Microprocessor built-in



⚠ Please read "Caution for your safety" in operation manual before using.

■ Specifications

※ A blacked () item is upgraded function.

Model		Single preset		FS4A	
		Indication type			FS5B
Digit				4	5
Digit size				W4 × H8mm	
Power supply				100–240VAC 50/60Hz, 12–24VDC (Option)	
Allowable voltage range				90 ~ 110% of rated voltage	
Power consumption				4VA	
Max. counting speed for CP1, CP2				Selectable 1cps/30cps/2kcps/5kcps by internal DIP switch	
Min. input signal width	RESET input			Approx. 20ms	
Input	COUNT IN			No-voltage input • Impedance at short-circuit : Max. 470kΩ • Residual voltage at short-circuit : Max. 1VDC • Impedance at open-circuit : Min. 100kΩ	
	RESET				
One-shot output time				0.05 ~ 5sec	
Control output	Contact	Type	SPST (1a)		
		Capacity	250VAC 3A resistive load		
Memory retention				10 years (When using non-voltage semiconductor memory)	
External sensor power				12VDC ±10% 50mA max.	
Insulation resistance				100MΩ (at 500VDC)	
Dielectric strength				2000VAC 50/60Hz for 1 minute	
Noise strength	AC power			±2kV the square wave noise (pulse width: 1μs) by the noise simulator	
	DC power			±500V the square wave noise (pulse width: 1μs) by the noise simulator	
Vibration	Mechanical			0.75mm amplitude at frequency of 10 ~ 55Hz in each of X, Y, Z directions for 1 hour	
	Malfunction			0.5mm amplitude at frequency of 10 ~ 55Hz in each of X, Y, Z directions for 10 minutes	
Shock	Mechanical			300m/s ² (Approx. 30G) in X, Y, Z directions 3 times	
	Malfunction			100m/s ² (Approx. 10G) in X, Y, Z directions 3 times	
Relay life cycle	Mechanical			Min. 10,000,000 times	
	Electrical			Min. 100,000 times (250VAC 3A at resistive load)	
Ambient temperature				-10 ~ +55°C (at non-freezing status)	
Storage temperature				-25 ~ +65°C (at non-freezing status)	
Ambient humidity				35 ~ 85%RH	
Weight	AC power			Approx. 122g	
	DC power			Approx. 130g	
				Approx. 112g	
				Approx. 120g	

8 Pin Plug Counter

Connections

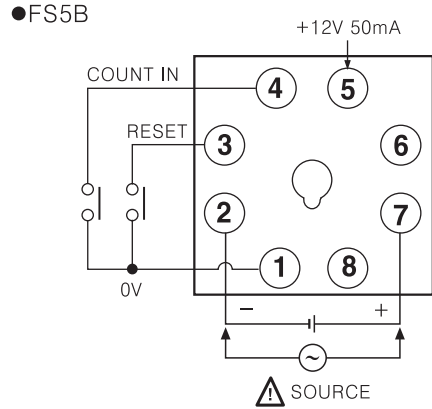
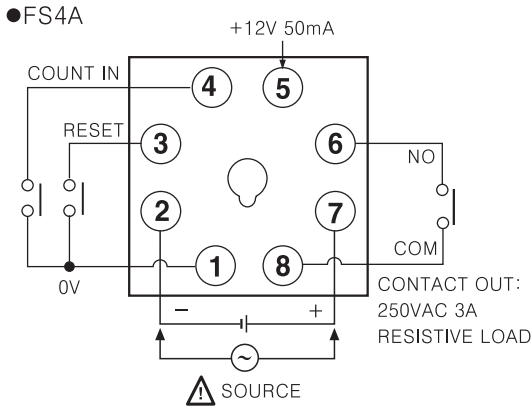

Dimensions

Bracket

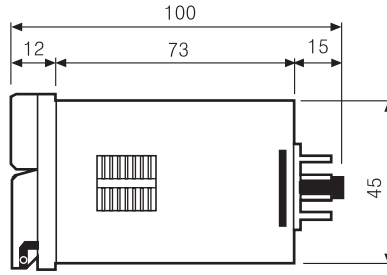
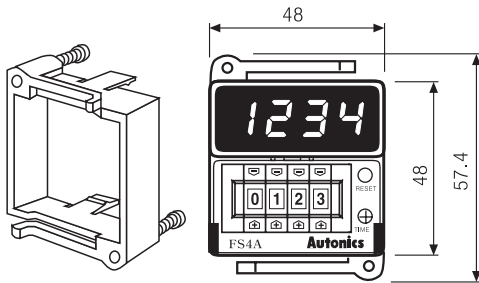

Panel cut-out

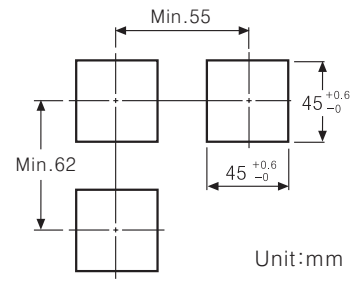

Socket (Accessory)

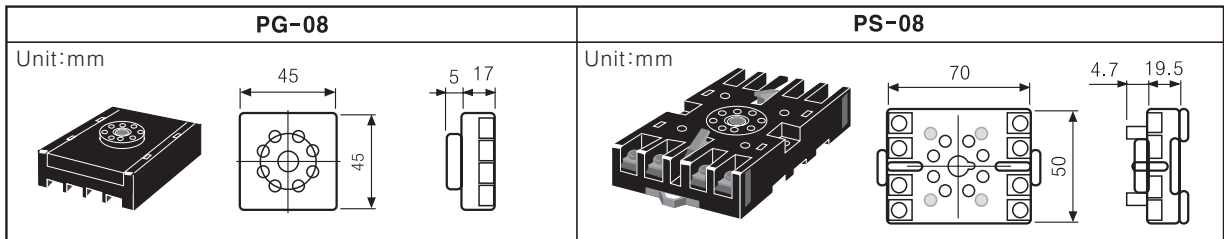

Input connections

Input logic : No-voltage input(NPN)

●Solid-state input(Standard input sensor :NPN output type sensor)

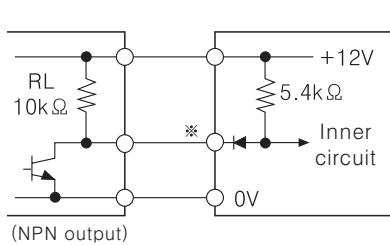

※COUNT IN, RESET input

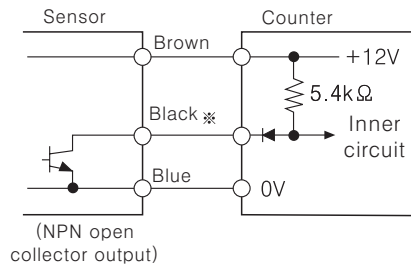

●Contact input

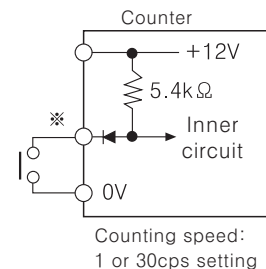

●PNP output type sensor

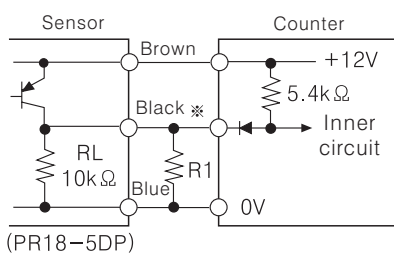

- PNP output type sensor cannot be used directly.
- RL : Resistive load of proximity sensor (Built in the sensor)
- R1 : Resister to be connected at out side
- Please set R1 value to make the composed resistance of RL+R1 is max. 470Ω (Be sure that RL value will be different by sensors)

(A)
Counter

(B)
Timer

(C)
Temp.
controller

(D)
Power
controller

(E)
Panel
meter

(F)
Tacho/
Speed/
Pulse
meter

(G)
Display
unit

(H)
Sensor
controller

(I)
Proximity
sensor

(J)
Photo
electric
sensor

(K)
Pressure
sensor

(L)
Rotary
encoder

(M)
5-Phase
stepping
motor &
Driver &
Controller

FS Series

◎Input & output connections

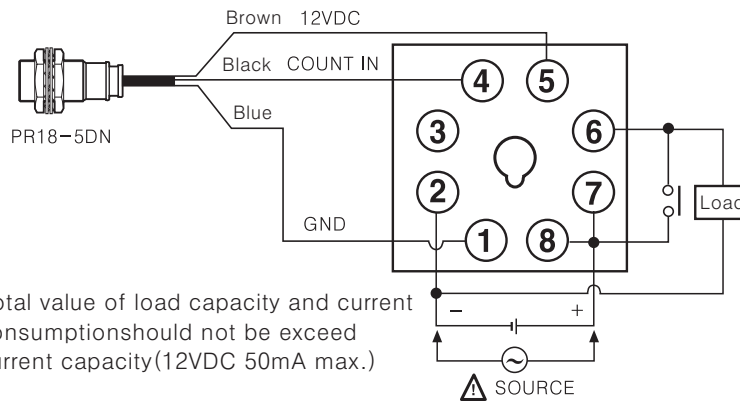

●Total value of load capacity and current consumptions should not exceed current capacity (12VDC 50mA max.)

●Please select proper capacity of load not to exceed contact capacity.
Contact capacity : 250VAC 3A Max.
Contact type : 1a

■ Selection by DIP switches

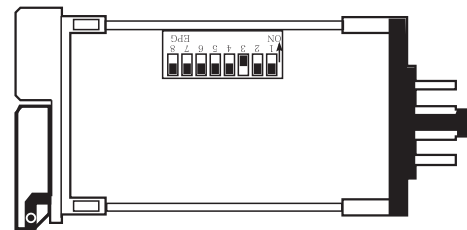
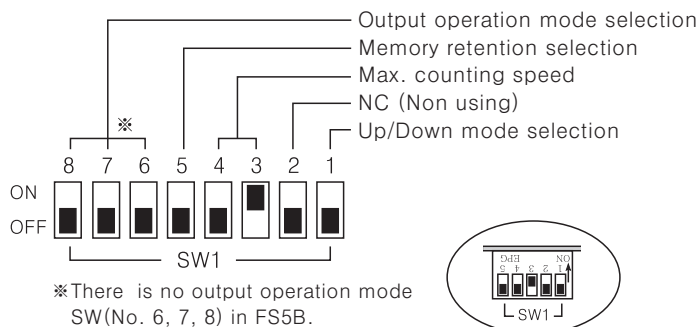

* DIP SW numbers are changed from 7 to 8

●Max. counting speed

SW1	Function						
<table border="1"> <tr><td>3</td><td>4</td></tr> <tr><td>ON</td><td>OFF</td></tr> <tr><td>OFF</td><td>ON</td></tr> </table>	3	4	ON	OFF	OFF	ON	1cps
3	4						
ON	OFF						
OFF	ON						
<table border="1"> <tr><td>3</td><td>4</td></tr> <tr><td>ON</td><td>ON</td></tr> <tr><td>OFF</td><td>ON</td></tr> </table>	3	4	ON	ON	OFF	ON	30cps
3	4						
ON	ON						
OFF	ON						
<table border="1"> <tr><td>3</td><td>4</td></tr> <tr><td>ON</td><td>ON</td></tr> <tr><td>OFF</td><td>OFF</td></tr> </table>	3	4	ON	ON	OFF	OFF	2kcps
3	4						
ON	ON						
OFF	OFF						
<table border="1"> <tr><td>3</td><td>4</td></tr> <tr><td>ON</td><td>ON</td></tr> <tr><td>OFF</td><td>ON</td></tr> </table>	3	4	ON	ON	OFF	ON	5kcps
3	4						
ON	ON						
OFF	ON						

●Up/Down mode

SW1	Function			
<table border="1"> <tr><td>1</td></tr> <tr><td>ON</td></tr> <tr><td>OFF</td></tr> </table>	1	ON	OFF	Down mode
1				
ON				
OFF				
<table border="1"> <tr><td>1</td></tr> <tr><td>ON</td></tr> <tr><td>OFF</td></tr> </table>	1	ON	OFF	Up mode
1				
ON				
OFF				

●Memory retention

SW1	Function			
<table border="1"> <tr><td>5</td></tr> <tr><td>ON</td></tr> <tr><td>OFF</td></tr> </table>	5	ON	OFF	Power reset (Non memory)
5				
ON				
OFF				
<table border="1"> <tr><td>5</td></tr> <tr><td>ON</td></tr> <tr><td>OFF</td></tr> </table>	5	ON	OFF	Memory
5				
ON				
OFF				

■ Decimal point setting

Display the decimal point.

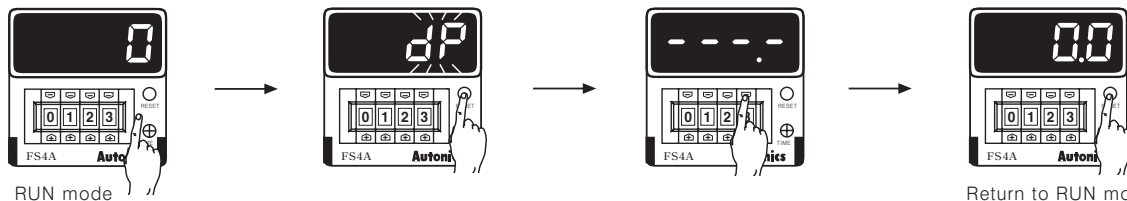

*It returns to decimal point setting status if pressing RESET button for over 3sec. in RUN mode.

*When "dp" is flickering, one touch the Reset button.

*If pressing one of digital switch buttons (↑, ↓) in decimal point setting mode, decimal point will be moved to Up(+) direction.

*It returns to RUN mode if pressing RESET button for over 3sec. in decimal point setting status.

●Changing the decimal point

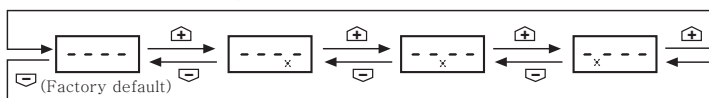

*It returns to RUN mode if no RESET button or digital switch is applied for 60sec. in decimal point setting status.

*The decimal point setting is existed in indication type.

8 Pin Plug Counter

Counting operation of indication mode(Indication model)

Up input mode

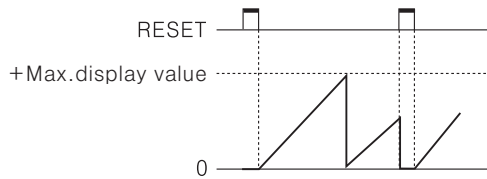

Down input mode

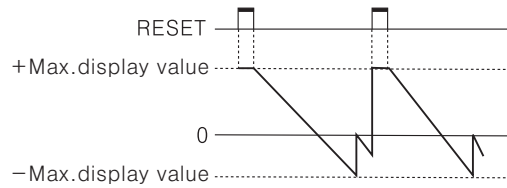

Output operation mode

← One-shot output(0.05 ~ 5sec)

← Self-holding output

Output mode (SW1)	ON OFF Up mode	ON OFF Down mode	Operation after count up
F ON OFF			The display value continues until reset signal is applied then output is held • Self-holding output is held until reset signal is applied.
N ON OFF			The display value and Self-holding output are held until reset signal is applied.
C ON OFF			The display value returns to reset start status when display value is reached to preset value.
R ON OFF			The display value is held until output is OFF then returns to reset start status.
K ON OFF			The display value continues until reset signal is applied.
P ON OFF			The display value is held during one-shot output time, counting process is returned to reset start status as soon as output is ON.
Q ON OFF			The display value continues during one-shot output time.
S ON OFF			<ul style="list-style-type: none"> • Up input mode –Output is ON when (Display value) \geq (Preset value) • Down input mode –Output is ON when (Display value) \leq (Zero)

(A) Counter

(B) Timer

(C) Temp. controller

(D) Power controller

(E) Panel meter

(F) Tacho/Speed/Pulse meter

(G) Display unit

(H) Sensor controller

(I) Proximity sensor

(J) Photo electric sensor

(K) Pressure sensor

(L) Rotary encoder

(M) 5-Phase stepping motor & Driver & Controller

FS Series

■ Proper usage

◎ Reset function

● Reset

In case of changing the input mode after supplying the power, please take a external reset or manual reset. **If reset is not executed, the counter will be working as previous mode.**

● Reset signal width

It is reset perfectly when the reset signal is applied during **min. 20ms** regardless of the contact input & solid-state input.

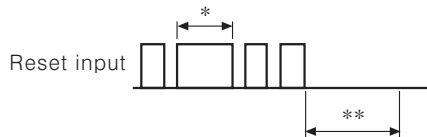

*In case of a contact reset, it is reset perfectly if the ON time of reset signal is applied during min. 20ms even though a chattering is occurred.

**It can be input the signal of CP1&CP2 after min. 50ms from closing time of reset signal.

◎ Sensor power

The power 12VDC which is provided to sensor is built in it. Please use it under Max. 50mADC.

◎ Min. signal width of CP1, CP2 input

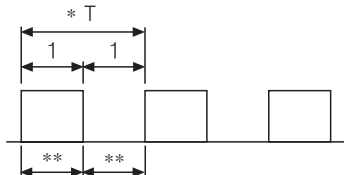

*Please make duty ratio(ON/OFF) 1:1.

** Min. signal width

{	1cps : Max. 0.5sec
	30cps : Max.16.7ms
	2kcps : Max. 0.25ms
	5kcps : Max.0.1ms

◎ Max. counting speed

This is respond speed per 1sec. when the duty ratio (ON/OFF) of input signal is 1:1.

If duty ratio is not 1:1, the respond speed will be getting slow against input signal and also the width between ON and OFF should be over min. signal width and also one of ON width and OFF width is Under min. signal width, this product may not response.

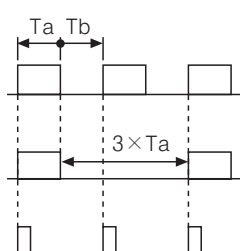

Width of Ta(ON) and Tb(OFF) must be larger than Min. signal width.

Max.counting speed is 1/2 value of catalog spec. when duty rate is 1:3.

It can not respond because Max. signal width(1a) is little.

◎ Error display

Error signal	Error description	Returning method
Err0	Zero set state	Change the set value to non zero state

*When Error is displayed, the output continues OFF state.

**There is no Error function in the indication type.

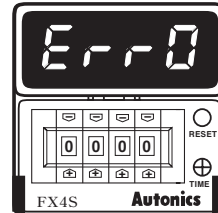

◎ Detach the case from body

While pushing the lock equipment with with driver to the way of front, push the terminal block.

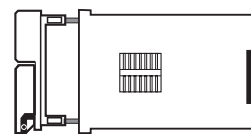
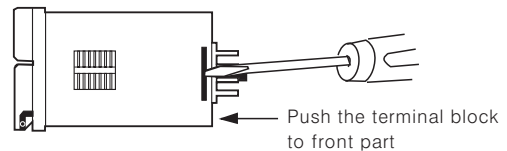

◎ Power

The inner circuit voltage starts to rise up for the first 100ms after power on, the input may not work at this time. And also the inner circuit voltage drops down for the last 500ms after power off, the input may not work at this time.

