

THD Series

Indoor, Duct & Wall Mounting Type Temperature/Humidity Transducer

■ Features

- Compact design
- Built-in temp./humidity sensor
- 7 Segment LED Display (THD-DD/THD-WD)
- Various output modes
DC4-20mA, 1-5VDC, RS485 (Modbus RTU)
- Wide range of temp./humidity measurement
-19.9 to 60.0°C / 0.0 to 99.9%RH
- Communication speed: 115200bps

⚠ Please read "Caution for your safety" in operation manual before using.

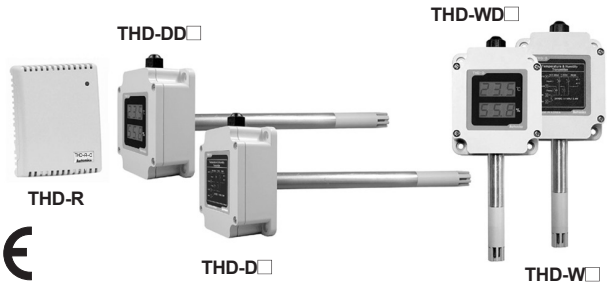

■ Ordering Information

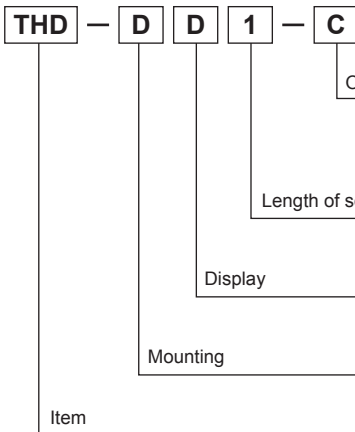

※ PT	DPT100Ω resistance value (Temp.)
※ PT/C	DPT100Ω resistance value (Temp.) / DC4-20mA current output (Humidity)
C	DC4-20mA current output (Temp./Humidity)
V	1-5VDC voltage output (Temp./Humidity)
T	RS485 communication output Modbus RTU (Temp./Humidity)
※ No mark	Built-in
1	100mm
2	200mm
No mark	Non-Display type
D	Display type
R	Room type (For indoor)
D	Duct mounting type
W	Wall mounting type
THD	Temperature Humidity Double

※ It is only for THD-R.

■ Specifications

Model	THD-R-PT	THD-R-PT/C	THD-R-C THD-R-V THD-R-T	THD-D□ - □ THD-W□ - □	THD-DD□ - □ THD-WD□ - □
Power supply	—	24VDC			
Allowable voltage range	—	90 to 110% of rated voltage			
Power consumption	—	Max. 2.4W			
Input type	Temperature (Built-in sensor)	Temperature, Humidity (Built-in sensor)			
Display type	Non-indicating type				7Segment LED display
Display digit	—				Each 3digits for temp./humidity
Character size	—				W6.2×H10.0mm
Measurement range	Temp.	-19.9 to 60.0°C			
	Humidity	—	0.0 to 99.9%RH (THD-R is required to attend for using over 90%RH.)		
Accuracy ^{※1}	Temp.	Max. ±0.8°C	±1.0°C (at room temperature)		
	Humidity	—	±3%RH (30 to 70%RH, at room temp.), ±4%RH (10 to 90%RH)	±2%RH (10 to 90%RH, at room temp.)	
Output ^{※2}	Temp.	DPT100Ω resistance value		DC4-20mA, 1-5VDC, RS485 communication output (Modbus RTU)	
	Humidity	—	DC4-20mA		
Sampling cycle	—				
Insulation resistance	—				
Dielectric strength	—				
Noise resistance	—				

※1: •Room temperature is 23°C±5°C.

- It may cause degree of degradation when this unit is exposed to organic chemicals such as alcohol gas or sulfuric acid.
- It may cause degree of degradation for humidity when using this unit at high temperature/humidity environment for a long time.
- It may cause error of humidity value when this unit is exposed to high humidity environment (over 80%RH) for a long time.

※2: The allowable impedance of current output is max. 600Ω.

Temperature/Humidity Transducer

Specifications

Model		THD-R-PT	THD-R-PT/C	THD-R-C THD-R-V THD-R-T	THD-D□-□ THD-W□-□	THD-DD□-□ THD-WD□-□
Vibration	Mechanical	—	0.75mm amplitude at frequency of 10 to 55Hz (for 1 min.) in each X, Y, Z direction for 1 hour			
	Malfunction	—	0.5mm amplitude at frequency of 10 to 55Hz (for 1 min.) in each X, Y, Z direction for 10 min.			
Shock	Mechanical	—	300m/s ² (approx. 30G) in each X, Y, Z direction for 3 times			
	Malfunction	—	100m/s ² (approx. 10G) in each X, Y, Z direction for 3 times			
Protection structure		IP10			IP65 (except sensing part)	
Ambient temperature		-20 to 60°C, storage: -20 to 60°C				
Cable		Terminal type			Ø4mm, 4-wire, Length: 2m	
Approval						
Weight ^{※3}		Approx. 98g (approx. 55g)			Approx. 415g (approx. 160g)	

※3: The weight includes packaging. The weight in parentheses is for unit only.

※Environment resistance is rated at no freezing or condensation.

Dimensions

(unit: mm)

● THD-R

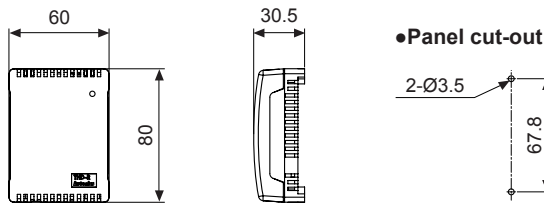

● THD-W

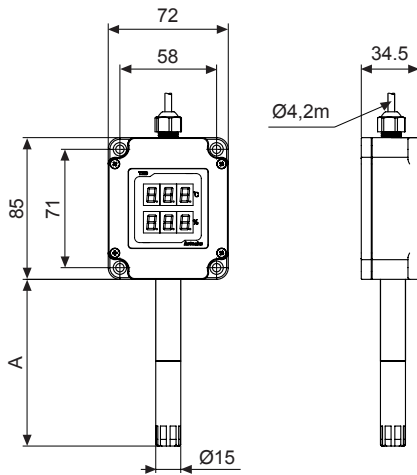

Model	Length of sensor pole (A)
THD-□1-□	100mm
THD-□2-□	200mm

● THD-D

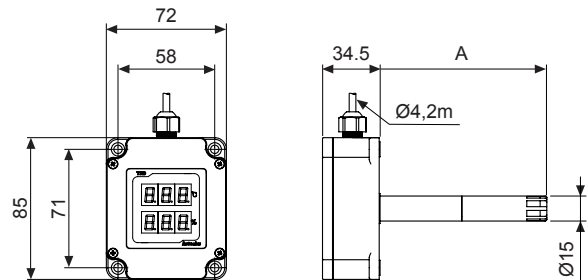

● Bracket

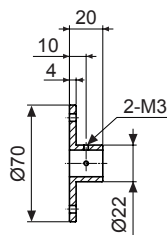

● Panel cut-out

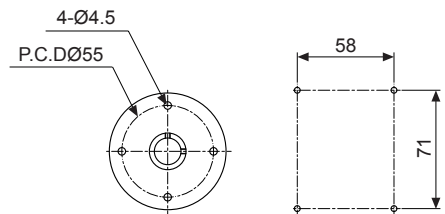

(A) Photoelectric Sensors

(B) Fiber Optic Sensors

(C) Door/Area Sensors

(D) Proximity Sensors

(E) Pressure Sensors

(F) Rotary Encoders

(G) Connectors/ Sockets

(H) Temperature Controllers

(I) SSRs / Power Controllers

(J) Counters

(K) Timers

(L) Panel Meters

(M) Tacho / Speed / Pulse Meters

(N) Display Units

(O) Sensor Controllers

(P) Switching Mode Power Supplies

(Q) Stepper Motors & Drivers & Controllers

(R) Graphic/ Logic Panels

(S) Field Network Devices

(T) Software

THD Series

Connections

THD-R

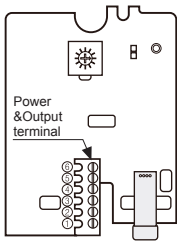

※Check the terminal connection diagram and be sure that when connecting the power.

THD-R-PT

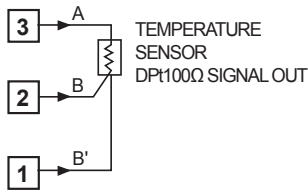

THD-R-PT/C

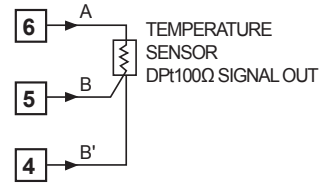

THD-R-C, V, T

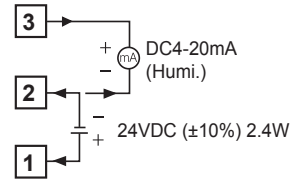
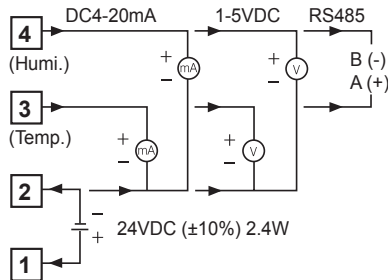

THD-D / THD-W

Current output type

DC4-20mA (Humi.)

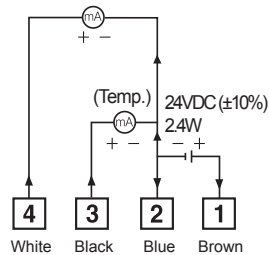
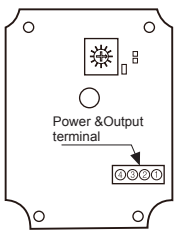

Voltage output type

1-5VDC (Humi.)

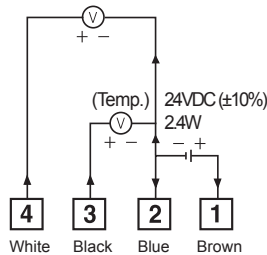

Comm. output type

RS485
(Temp. & Humi.)

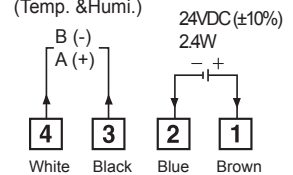

Case Detachment

THD-R

Unfasten the bolt on the bottom of the product, separate the case from it.

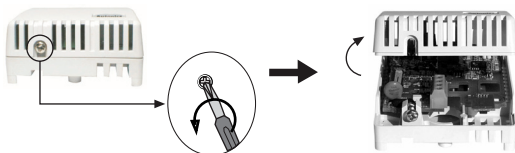

THD-D / THD-W

Unfasten 4 bolts on the top of the product, separate the case cover from it.

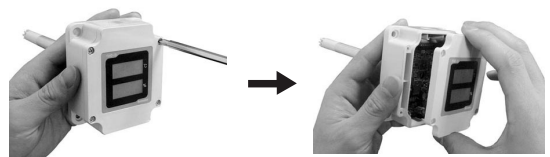

Temperature/Humidity Transducer

■ Functions

◎ Voltage output

It transmits current temperature/humidity to other devices (PC, recorder, etc.) and outputs 1-5VDC. It outputs 1VDC at -19.9°C of temperature and 0%RH of humidity, 5VDC at 60°C of temperature and 99.9%RH of humidity. The temperature and humidity output are separated and the resolution is divisible by 1,000.

◎ Current output

It transmits current temperature/humidity to other devices (PC, recorder, etc.) and outputs DC4-20mA. It outputs DC4mA at -19.9°C of temperature and 0%RH of humidity, DC20mA at 60°C of temperature and 99.9%RH of humidity. The temperature and humidity output are separated and the resolution is divisible by 1,000.

◎ Temperature sensor output (DPT 100Ω resistance value output)

It transmits current temperature to other devices (recorder, thermometer, etc.). It outputs 100Ω at 0°C and 119.40Ω at 50°C. (TCR=3850 ppm/°C)

■ Comprehensive Device Management Program [DAQMaster]

DAQMaster is comprehensive device management program for convenient management of parameters and multiple device data monitoring. Visit our website (www.autonics.com) to download user manual and comprehensive device management program.

■ RS485 Communication Output

It is output transmit current temperature and humidity to other devices by communication.

◎ Interface

Standard	EIA RS485
Maximum connections	31 (Address setting: 01 to 31)
Communication method	2-wire half duplex
Synchronous method	Asynchronous
Effective communication distance	Max. 800m
Communication speed	1200 to 115200bps (Setting)
Start bit	1bit (Fixed)v
Stop bit	1bit (Fixed)
Parity bit	None (Fixed)
Data bit	8bit (Fixed)
Protocol	Modbus RTU

- ※It is not possible to change parameter related to communication of THD under the communication with high order system.
- ※Match the parameter of THD communication to be same as the high order system.
- ※It is not allowed to set overlapping communication address at the same communication line.
- ※Please use a proper twist pair for RS485 communication.

◎ Application of system organization

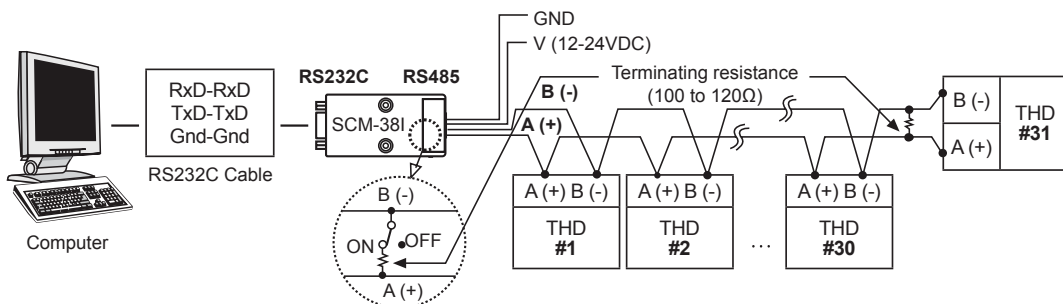

- ※It is recommended to use communication converter, RS232C to RS485 converter (SCM-381, sold separately), USB to RS485 converter (SCM-US481, sold separately).

(A) Photoelectric Sensors

(B) Fiber Optic Sensors

(C) Door/Area Sensors

(D) Proximity Sensors

(E) Pressure Sensors

(F) Rotary Encoders

(G) Connectors/Sockets

(H) Temperature Controllers

(I) SSRs / Power Controllers

(J) Counters

(K) Timers

(L) Panel Meters

(M) Tacho / Speed / Pulse Meters

(N) Display Units

(O) Sensor Controllers

(P) Switching Mode Power Supplies

(Q) Stepper Motors & Drivers & Controllers

(R) Graphic/Logic Panels

(S) Field Network Devices

(T) Software

THD Series

◎ Ordering of communication control

- The communication method is Modbus RTU.
- After 0.5sec. being supplied the power into master system, it is able to start communication.
- The initial communication is started by master system. When a command comes out from the master system, THD will respond.

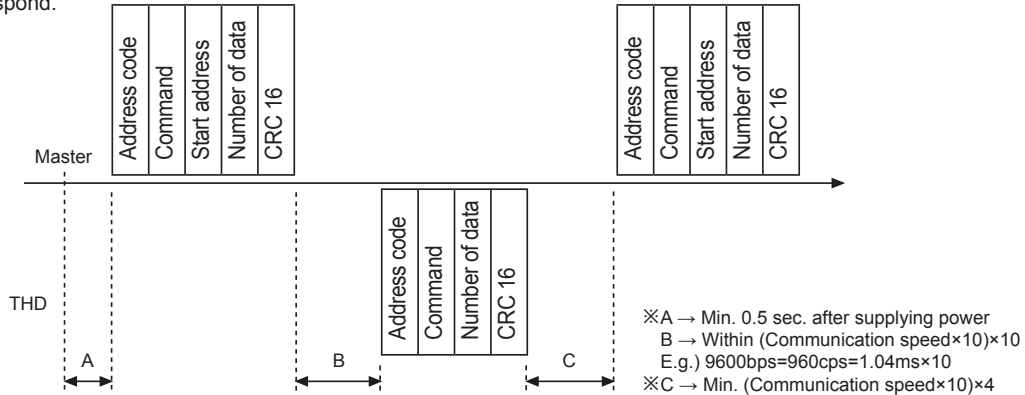

● Communication command and block

The format of query and response.

Query

Address code	Command	Start address	Number of data	CRC16
← Calculation range of CRC16 →				

- ① Address code: This address code is for identifying THD by master system and able to set within range of 01 to 31.
- ② Command: Read command for input register
- ③ Start address: The start address of input register to read (Start address). It is available to select 0000 and 0001 for start address. 16bit data in the address 0000 indicates temperature value, 16bit data in the address 0001 indicates humidity value. (Refer to Modbus Mapping table.)
- ④ Number of data: The number of 16bit data from start address (No. of Points). When start address is 0000, it is available to read 2 of 16 bit data, or when start address is 0001, it is available to read 1 of 16 bit data.
- ⑤ CRC16: Checksum for checking the whole frame and it is used for more reliable transmit/receive to check the error between transmitter and receiver.

Response

Address code	Command	Number of data	Temperature data	Humidity data	CRC16
← Calculation range of CRC16 →					

- ① Address code: This address code is for identifying THD by master system and able to set within range of 01 to 31.
- ② Command: A response for read command of input register
- ③ Number of data: The number of 8 bit data to send from start address (No. of bytes). When start address is 0000, it is available to read 4 of 8 bit data, or when start address is 0001, it is available to read 2 of 8 bit data.
- ④ Temperature data: This is the value of 16bit. To get a current temperature value, divide read value by 100.
E.g.)When read data is 0×09B0, decimal value is 2480, the current value is 2480/100=24.80°C.
- ⑤ Humidity data: This is the value of 16bit. To get a current humidity value, divide read value by 100.
E.g.)When read data is 0×0B68, decimal value is 2920, the current value is 2920/100=29.20%RH.
- ⑥ CRC16: Checksum for checking the whole frame.

● Application for communication command

(Query): Address code (01), Start address (0000), The number of 16 bit data to read (2) CRC16 (0x71CB)

01	04	00	00	00	02	71	CB
Address code	Command	Start address		Amount of data		CRC16	
		High	Low	High	Low	High	Low

(Response): Address code (01), The number of 8 Bit data to read (4), Temperature (0x09B0), Humidity (0x0B68) CRC (0x94DE)

01	04	04	09	B0	0B	68	94	DE
Address code	Response command	Amount of data	Temperature data		Humidity data		CRC16	
			High	Low	High	Low	High	Low

Temperature/Humidity Transducer

● Error processing (Slave → Master)

1. Not supported command

01	8X	01	XX	XX
Address code	Response command	Exception code	CRC16	

※Set a received highest bit and send it to response command and exception code 01.

2. The start address of queried data is inconsistent with the transmittable address or the requested number of data is bigger than the transmittable address.

01	84	02	C2	C1
Address code	Response command	Exception code	CRC16	

※Set a received highest bit and send it to response command and exception code 02.

◎ Setting communication speed

- 1) Set SW1 to 0 and apply the power.
- 2) Operation indicator LED is flashing.
- 3) Set a communication speed after choose SW1 within the range 1 to 8 and hold it for 3sec.
- 4) After setting a communication speed, the LED will be ON. At the moment turn OFF the power.

※Factory default communication speed is 9600bps.

※In order to change the communication speed, please turn off the power and repeat step 1 to 4.

<Setting table for communication speed (bps)>

SW1	Communication speed (bps)
1	1200
2	2400
3	4800
4	9600
5	19200
6	38400
7	57600
8	115200

◎ Change the communication address

- 1) Set RS485 terminal and SW1 at new address, apply the power.
 - 2) The communication address is changed automatically.
- ※Factory default communication address is 01. (SW1: 1, RS485 terminal: Open)
- ※In order to change the communication address, please turn off the power and repeat step 1) to 2).
- ※Setting table of communication address

RS485 terminal	SW1	Add no.	RS485 terminal	SW1	Add no.
OPEN	1	01	SHORT	0	16
OPEN	2	02	SHORT	1	17
OPEN	3	03	SHORT	2	18
OPEN	4	04	SHORT	3	19
OPEN	5	05	SHORT	4	20
OPEN	6	06	SHORT	5	21
OPEN	7	07	SHORT	6	22
OPEN	8	08	SHORT	7	23
OPEN	9	09	SHORT	8	24
OPEN	A	10	SHORT	9	25
OPEN	B	11	SHORT	A	26
OPEN	C	12	SHORT	B	27
OPEN	D	13	SHORT	C	28
OPEN	E	14	SHORT	D	29
OPEN	F	15	SHORT	E	30
—	—	—	SHORT	F	31

<Inner PCB of THD-R>

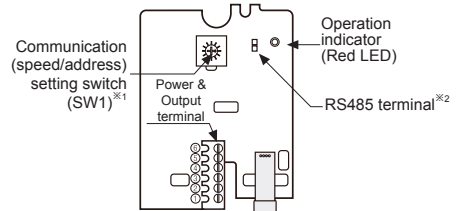

<Inner PCB of THD-D/THD-W>

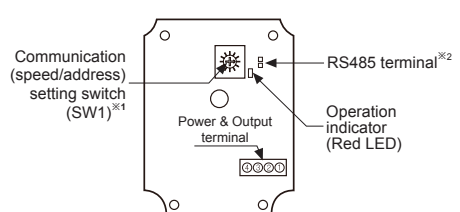

- ※1. Only when communication setting, remove the case cover and adjust the communication setting switch to set address and communication speed.
- ※2. Short terminal as upper address setting terminal, the lower address setting is available.

◎ Modbus Mapping Table

Address	Item	Remark
30001 (0000)	Temperature value	Temperature value × 0.01
30002 (0001)	Humidity value	Humidity value × 0.01

※Visit our website (www.autonics.com) to download monitoring program for RS485 communication output.

(A)	Photoelectric Sensors
(B)	Fiber Optic Sensors
(C)	Door/Area Sensors
(D)	Proximity Sensors
(E)	Pressure Sensors
(F)	Rotary Encoders
(G)	Connectors/ Sockets
(H)	Temperature Controllers
(I)	SSRs / Power Controllers
(J)	Counters
(K)	Timers
(L)	Panel Meters
(M)	Tacho / Speed / Pulse Meters
(N)	Display Units
(O)	Sensor Controllers
(P)	Switching Mode Power Supplies
(Q)	Stepper Motors & Drivers & Controllers
(R)	Graphic/ Logic Panels
(S)	Field Network Devices
(T)	Software

THD Series

■ Caution During Use

- After checking the input specification, terminal polarity, connect the wires correctly.
- Do not connect a wire, examine and repair when the power is applying.
- Do not touch the temperature/humidity sensor by hands.
- When removing a packing box, do not store this unit at the high temperature/humidity environment.
- Do not use or storage this unit at over the 90%RH for a long time.
- This unit must be mounted on the wall. (THD-R)
- Caution for cleaning
 - Use dry towel.
 - Do not use acid, chrome acid, solvent but alcohol.
 - Turn off the power before cleaning the unit. After 30min. of cleaning, supply the power to the unit.
- Do not inflow dust or wire dregs into the unit.
- The connection wire of this unit should be separated from the power line and high voltage line in order to prevent from inductive noise.
- Keep away from the high frequency instruments. (High frequency welding machine & sewing machine, big capacitive SCR controller)
- The switch or circuit-breaker should be installed near by users.
- This unit may be used in the following environments
 - Indoor
 - Altitude: Under 2,000m
 - Pollution degree 2
 - Installation category II