

Autonics

Serial Converter Module SCM Series

M A N U A L



Thank you very much for selecting Autonics products.
For your safety, please read the following before using.

Caution for your safety

- Please keep these instructions and review them before using this unit.
- Warning: Serious injury may result if instructions are not followed.
- Caution: Product may be damaged, or injury may result if instructions are not followed.
- The following is an explanation of the symbols used in the operation manual.

Warning

- In case of using this unit with machineries (Nuclear power control, medical equipment, vehicle, train, airplane, combustion apparatus, entertainment or safety device etc), it requires installing fail-safe device, or contact us for information required.
- Do not connect, inspect and repair when power is ON.
- Do not disassemble and modify this unit, when it requires. If needs, please contact us.
- Do not put metal materials in this unit.
- Do not separate a terminal block while it is operating.
- Do not turn off while it is operating.
- Please separate as industrial waste when disusing this unit.

Caution

- This unit shall not be used outdoors.
- Do not insert any other connector except dedicated connector.
- Please observe specification rating.
- Do not in-flow dust or wire drops into inside of this unit.
- When connector is not inserted or disconnected easily, do not apply excessive force.
- Do not disconnect USB connector and Earphone Jack while it is operating and do not quickly and repeatedly connect and disconnect the USB connector.
- Connect to the unit based on description and make sure that connection is correct.
- Please use a dedicated driver for M2 screw at RS485 connector and the specified torque is 0.22 ~ 0.29N·m and the max. torque is 0.4N·m.
- In cleaning the unit, do not use water or an oil-based detergent.
- Do not use this unit at place where there are flammable or explosive gas, humidity, direct ray of the sun, radiant heat, vibration, impact etc.
- Please note the seller or user that the devices (Class A) complies with EMC registration for the purpose of being used in areas except home.

Proper usage

- TX_Enable signal(RTS signal)**
In case of SCM-381 and SCM-US481, Tx_Enable signal (RTS signal) is automatically generated according to protocol. (Do not need to generate signal on your own)
- Auto-loop Back**
SCM-381 has Auto-loop Back function. When using Auto-loop back function, please use as 'RS232C' cable connections.
- Termination Resistor**
RS485 Communication has many advantages such as fast transmission rate, long distance communication and etc. But if the impedance of transmission line does not match to RS485 network terminations, the reflected wave will be generated. In case of increasing the length of transmission line or using 1:N multi-drops, the reflected wave may cause transmission error. Therefore in this case, please use termination resistor(100 to 120Ω) at both terminations.

Features

| SCM-US | SCM-381 | SCM-US481 |
|---|---|--|
| -USB ↔ Serial -Communication cable is specifically designed to connect to Autonics products. -Non-isolation type -Applicable OS: Windows 98/98SE/ME/2000/Server 2003/XP/Vista/7 -Built-in ferrite core cable for noise reduction -Both USB 1.1, USB 2.0 compatible -Data transmission/power supply indicating LED -Easy to connect with PC -Built-in protection circuit | -RS232C ↔ RS485 -Isolating RS485 Transceiver(2500V/RMS) -Built-in protection circuit -Tx-Enable signal (RTS signal) is automatically generated | -USB ↔ RS485 -Isolating RS485 Transceiver(2500V/RMS) -Applicable OS: Windows 98/98SE/ME/2000/Server 2003/XP/Vista/7 -Built-in ferrite core USB 2.0 AB cable for noise reduction -Both USB 1.1, USB 2.0 compatible -Power supply ON/OFF indicating LED -Easy to connect with PC -Built-in protection circuit |

Specifications

| Model | SCM-US | SCM-381 | SCM-US481 |
|----------------------------------|---|--|--|
| Power supply | 5VDC USB bus Power (※1) | 12-24VDC ± 10% | 5VDC USB bus Power (※1) |
| Power consumption | Approx. 1W | Approx. 1.7W | Approx. 1W |
| Communication speed | (※2) 1,200 ~ 115,200bps (Recommended: 9,600bps) | | |
| Communication type | Half Duplex type | | |
| Available communication distance | 1.5m(No extension) | Max. 1.2km | USB: Max. 1m± 30% RS485: Max. 1.2km |
| Multi-drop | - | Max. 31 Multi-drop | - |
| Protocol | Data Bit: - Stop Bit: - Parity Bit: - | 5 to 8 1 or 2 None/Odd/Even | - |
| Connection type | USB: A type connector Earphone Jack (4 pole stereo phone plug) | RS232C: D-sub 9Pin RS485: 4 wire Screw terminal(2 wire communication type) | USB: B type connector |
| Isolation type | Non-isolation | Isolation | Isolation |
| Dielectric strength | - | Between terminals and case: 2000VAC 50/60Hz for 1 min. Between RS232C and RS485: 2500VAC 50/60Hz for 1 min. | Between terminals and case: 2500VAC 50/60Hz for 1 min. Between RS232C and RS485: 2500VAC 50/60Hz for 1 min. |
| Isolation resistance | - | 100MΩ (500VDC megger) | - |
| Dielectric strength | - | ± 500V the square wave noise (plus width: 1μs) by the noise simulator | - |
| Vibration | Mechanical: 0.75mm amplitude at frequency of 10 to 55Hz in each of X, Y, Z directions for 1hour Malfunction: 0.5mm amplitude at frequency of 10 to 55Hz in each of X, Y, Z directions for 10 minutes | - | - |
| Shock | Mechanical: 300m/s ² (30G) X, Y, Z directions for 3 times Malfunction: 100m/s ² (10G) X, Y, Z directions for 3 times | - | - |
| Ambient temperature | -10 to 55°C(at non-freezing status) | | |
| Storage temperature | -20 to 60°C(at non-freezing status) | | |
| Ambient humidity | 35 to 85%RH | | |
| Approval | CE | - | - |
| Weight | Approx. 41g | Approx. 46g | Approx. 34.5g |

※1: USB bus Power is supplied from PC or USB host controller.
※2: Protocol and Communication speed are set by Hyper terminal, DAQ master, ParaSet, Modbus Poll.
When communicating with Autonics products, set communication speed to 9,600bps.
※ There might be some differences in the specification above depending on PC environment.
※The above specifications are subject to change without notice.

Dimensions

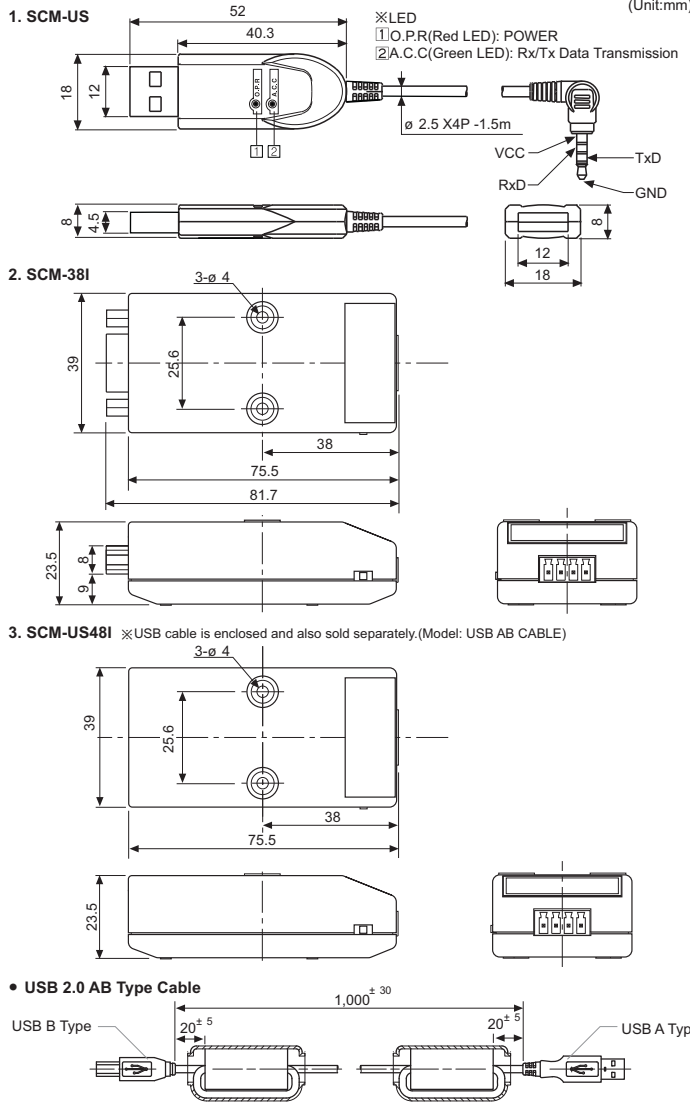

Panel mounting

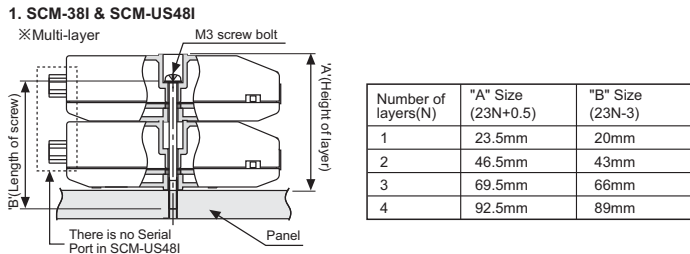

Connection and Installation

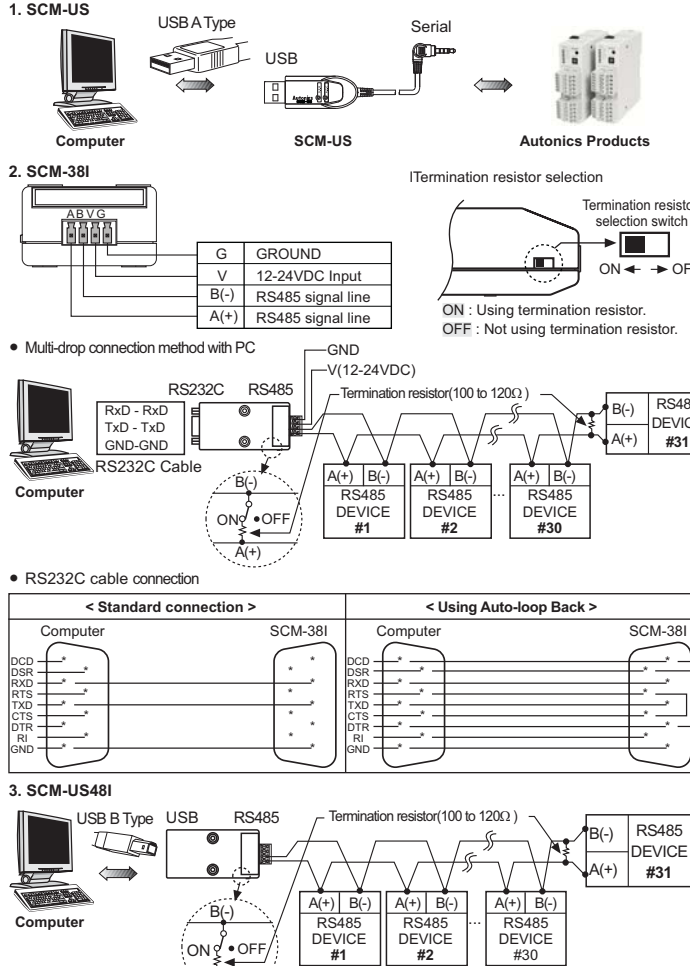

Caution for using

- In case of connecting PC with SCM-US/SCM-US481, when changing PC USB port and connecting this unit to another (changed) USB port, USB driver will be reinstalled. This is not a malfunction.
- When connecting SCM-US or SCM-US481 communication module, please connect PC first. Then, connect RS485 communication product afterward. When disconnecting the units, remove the unit in reverse order.
- Using the Twist pair cable(AWG 24), which is suitable to RS485 communication is recommended. If the Twist pair cable is not used, be sure preserving identically the length of A(+) and B(-) cables.
- After connecting SCM-381, SCM-US481 with RS485 communication DEVICE, be sure to attach the termination resistor(100 to 120Ω).
- In case of connect PC with SCM-US or SCM-US481, No. of COM Port will be numbered in order. This is not a malfunction. (e.g., COM 14, COM 15.....COM 256)
- When connecting SCM-US or SCM-US481 with USB cable, check COM port number before communication. It may take some time for computer to detect the cable after the cable is connected. (This is not a malfunctions)
- When connecting PC with SCM-US or SCM-481, do not use the extension cable to extend USB cable length. It may cause a malfunction.
- Be cautious when using SCM-US as non-isolated type.
- Only use Autonics products that are available for SCM-US.
- Observe the rated voltage.
- To avoid malfunctions due to noise, do not place the unit close to a high-voltage power line.
- Do not use this unit at below places because of product damage.
 - Place where there are severe vibration or impact
 - Place where strong alkalis or acids are used
 - Place where there are direct ray of the sun
 - Place where strong magnetic field or electric noise are generated
- Storage
 - Keep the unit -20 to 60°C, 35 to 85% RH with avoiding direct rays of light. It is recommended to keep the unit package as it is.
- Installation environment
 - It shall be used indoor
 - Altitude Max. 2,000m
 - Pollution Degree 2
 - Installation Category I

※It may cause malfunction if above instructions are not followed.

Driver Installation(SCM-US, SCM-US481)

- USB Driver Installation**
 - Visit our website(www.autonics.com).
 - Download USB Driver by type in keyword in the search box or choose Model, series and Material at Support-> download center.
 - Search by keyword**
 - Enter 'SCM-US' or 'SCM-US481' in the search box.
 - Download 'SCM-US USB Driver' or 'SCM-US481 USB Driver'.
 - Search by category**
 - Select Temperature Controller at '1 Step: Product list'.
 - Select 'SCM-US' or 'SCM-US481' at '2 Step : Series list'.
 - If select software at the document lists, SCM-US USB Driver or SCM-US481 USB Driver will be displayed.
 - Download suitable Driver.
 - Unzip download 'SCM-US.zip' or 'SCM-US481.zip' at any directory.
- When connecting product with USB port, 'Found New Hardware Wizard' will appear automatically. 'Do you want to search software by connecting 'Window Update'?'. Click 'No' button and the following window will be displayed to proceed Driver installation. Select 'Install from a list or specific location (Advanced)' and click 'Next'.
- Select 'Search for best driver in these locations' and 'include this location in the search' continuously. Click the 'Browse' button.
- When 'Browse Folder' window is displayed, select 'SCM-US\Driver' and click 'Finish'. Click 'Next' to proceed with the USB Driver installation.
- Hardware installation message will appear while Found New Hardware Wizard is running. Click 'Continue Anyway' to proceed with installation.

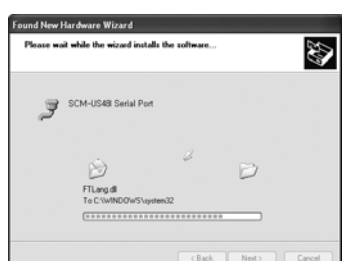
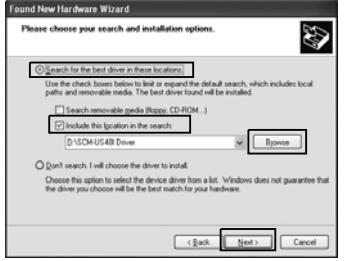
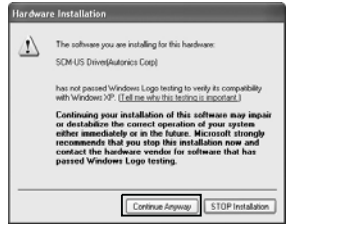
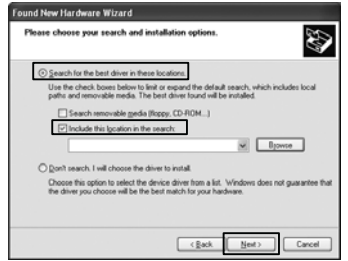

- The following window will be displayed if the USB Driver is installed properly. Click the 'Finish' button.

- Serial Port Driver Installation
 - After installing USB Driver, Serial Port (COM port), 'Found New Hardware Wizard' will appear. (Serial Port Driver installation follows the same procedures described in installing USB Driver).
 - After selecting 'Install from a list or specific location(advance)', click 'Next' button. The following window will be displayed for 'Search and installation options'
 - Because a driver location was selected when installing USB driver, click 'Next' button.
 - Hardware installation message will appear while Found New Hardware Wizard is running. Click 'Continue Anyway' to proceed with installation.
 - 'Completing the Found New Hardware wizard' will be displayed if the Serial Port Driver is installed properly. Click the 'Finish' button.

※Verify that drivers were installed properly with the windows Device Manager after finishing USB Driver and Serial Port Driver installation.

Open the folder [My computer], open the system folder (click right), click the hardware tab, and click the device manager button. Then, make sure that 'SCM-US Serial Port (COM X)' or 'SCM-US481 Serial Port (COM X)' is found in 'Port (COM and LPT)' and 'SCM-US Driver(Autonics Corp)' or 'SCM-US481 Driver (Autonics Corp)' is found in 'Common Serial Bus Controller' category.

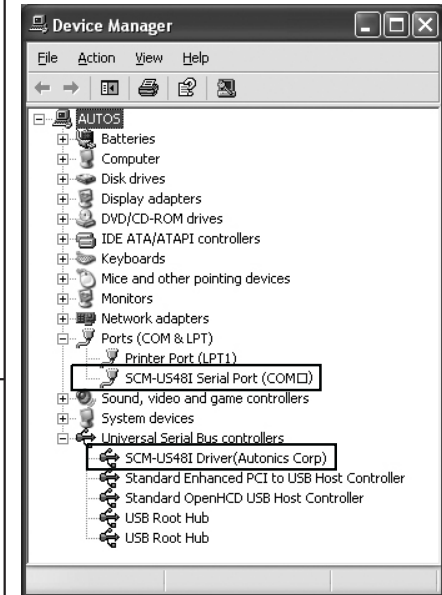

※This Driver Installation shows the procedure for Window XP. There might be some differences in the specification above depending on OS.

Major products

- Proximity sensors
- Area sensors
- Door/Door side sensors
- Counters
- Rotary encoders
- Power controllers
- Panel meters
- Temperature controllers
- Tachometer/Pulse(Rate) meters
- Temperature/Humidity transducers
- Switching power supplies
- Stepping motors/drivers/motion controllers
- Field network devices
- Laser marking system(CO₂, Nd:YAG)
- Laser welding/soldering system
- Photoelectric sensors
- Fiber optic sensors
- Pressure sensors
- Timers
- Display units
- Sensor controllers
- Graphic/Logic panels

Autonics Corporation
http://www.autonics.com

Satisfiable Partner For Factory Automation

HEADQUARTERS :
41-5, Yongdang-dong, Yangsan-si, Gyeongsang, 628-847, Korea

OVERSEAS SALES :
Bldg. 402 3rd Fl., Busheon Techno Park, 193, Yakhdae-dong, Wornmi-gu, Busheon-si, Gyeonggi-do, 420-734, Korea
TEL:82-32-610-2730 / FAX:82-32-329-0728
E-mail : sales@autonics.com

The proposal of a product improvement and development : product@autonics.com