

---

# Inverter

Inverter - control cabinet



---

**Contents**

**About Lenze** ..... **4**

    The 5 phases ..... 4

    Portfolio overview ..... 5

    Inverter overview ..... 6

**About this document** ..... **9**

    Document description ..... 9

    Notations and conventions ..... 10

**Inverter i550 Cabinet** ..... **12**

**Appendix** ..... **190**

    Good to know ..... 190

        Approvals/directives ..... 190

        Operating modes of the motor ..... 191

        Motor control types ..... 192

        Switching frequencies ..... 194

        Enclosures ..... 195

# About Lenze

The 5 phases



---

## About Lenze

### The 5 phases

#### **Lenze makes many things easy for you.**

With our motivated and committed approach, we work together with you to create the best possible solution and set your ideas in motion - whether you are looking to optimise an existing machine or develop a new one. We always strive to make things easy and seek perfection therein. This is anchored in our thinking, in our services and in every detail of our products. It's as easy as that!

#### **1 Developing ideas**

Are you looking to build the best machine possible and already have some initial ideas? Then get these down on paper together with us, starting with small innovative details and stretching all the way to completely new machines. Working together, we will develop an intelligent and sustainable concept that is perfectly aligned with your specific requirements.

#### **2 Drafting concepts**

We see welcome challenges in your machine tasks, supporting you with our comprehensive expertise and providing valuable impetus for your innovations. We take a holistic view of the individual motion and control functions here and draw up consistent, end-to-end drive and automation solutions for you - keeping everything as easy as possible and as extensive as necessary.

#### **3 Implementing solutions**

Our easy formula for satisfied customers is to establish an active partnership with fast decision making processes and an individually tailored offer. We have been using this principle to meet the ever more specialised customer requirements in the field of machine engineering for many years.

#### **4 Manufacturing machines**

Functional diversity in perfect harmony: as one of the few full-range providers in the market, we can provide you with precisely those products that you actually need for any machine task — no more and no less. Our L-force product portfolio a consistent platform for implementing drive and automation tasks, is invaluable in this regard

#### **5 Ensuring productivity**









Productivity, reliability and new performance peaks on a daily basis these are our key success factors for your machine. After delivery, we offer you cleverly devised service concepts to ensure continued safe operation. The primary focus here is on technical support, based on the excellent application expertise of our highly-skilled and knowledgeable after-sales team.

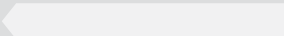

## Portfolio overview

Lenze products undergo the most stringent testing in our own laboratory. This allows us to ensure that you will receive consistently high quality and a long service life. In addition to this, five logistics centres ensure that the Lenze products you select are available for quick delivery anywhere across the globe.

As easy as that.

Controlling and visualising events	Automating and visualising machine modules	Automating and visualising machines
Logic Control	Machine module-Control	Machine Control
Visualisation		
Controllers		
		
Time and event-controlled motion	Speed and torque-controlled motion	Position-controlled single-axis and multi-axis motion
Mains operation	Inverter operation	Servo inverter operation
Inverters		
		
Motors		
Gearboxes		
		



# About Lenze

## Inverter overview



### Inverter overview

#### Comparison of i500

Inverter	i510			i550				
								
Application area	Pumps and fans, conveyor, travelling, winding, forming, tool and hoist drives							
Electrical supply system	1/N/PE AC 170 ... 264 V 45 ... 65 Hz	1/3/PE AC 170 ... 264 V 45 ... 65 Hz	3/PE AC 340 ... 528 V 45 ... 65 Hz	1/N/PE AC 90 ... 132 V 45 ... 65 Hz	1/N/PE AC 170 ... 264 V 45 ... 65 Hz	1/3/PE AC 170 ... 264 V 45 ... 65 Hz	3/PE AC 170 ... 264 V 45 ... 65 Hz	3/PE AC 340 ... 528 V 45 ... 65 Hz
Mot power	0.25 ... 2.2 kW	0.25 ... 2.2 kW	0.37 ... 2.2 kW	0.25 ... 1.1 kW	0.25 ... 2.2 kW	0.25 ... 2.2 kW	4.0 ... 5.5 kW	0.37 ... 75 kW
Inverter output current	1.7 ... 9.6 A	1.7 ... 9.6 A	1.3 ... 5.6 A	1.7 ... 6 A	1.7 ... 9.6 A	1.7 ... 9.6 A	16.5 ... 23 A	1.3 ... 150 A
Inverter efficiency class	IE2 according to EN 50598-2							
Max. inverter output current	150 % at an overload time of 60 s 200 % at an overload time of 3 s							
RFI filter	Integrated	not integrated	Integrated	not integrated	Integrated	not integrated	not integrated	Integrated
Dissipation of regenerative energy	-	-	-	Brake resistor	Brake resistor	Brake resistor	Brake resistor	Brake resistor DC-bus connection
Inverter version	Control cabinet							
Enclosure	IP20 according to EN 60529							
Inverter mounting type	Installation, easy mounting via keyhole suspension							
Control connections and networks	Basic I/Os  5 digital inputs - 1 digital output 2 analog inputs - 1 analog output  Modbus RTU or CANopen (switchable)			Standard I/O  5 digital inputs - 1 digital output 2 analog inputs - 1 analog output HTL incremental encoder via 2 digital inputs  Modbus RTU Modbus TCP CANopen EtherCAT EtherNet/IP PROFIBUS PROFINET Ethernet POWERLINK  Application I/O 7 digital inputs - 2 digital outputs 2 analog inputs - 2 analog outputs HTL incremental encoder via 2 digital inputs				
More connections	Relay			Relay Connection for PTC or thermal contact External 24 V supply				
Functional safety	Without			STO (Safe torque off)				
Approvals	CE, RoHS2, UL (for USA and Canada), EAC							
Interference suppression	Residential areas C1, industrial premises C2							

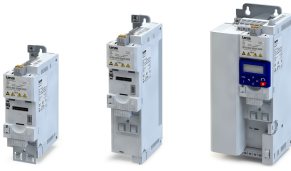

Functions	Inverter		Available as of firmware version				
	i510	i550	V1.1	V2.1	V3.0	V4.1	V5.0
<b>Motor control</b>							
V/f characteristic control linear/square-law (VFC plus)	•	•	•				
V/f characteristic control Midpoint	•	•			•		
V/f characteristic control (VFC closed loop)		•				•	
Sensorless vector control (SLVC)	•	•	•				
Energy saving function (VFC-ECO)	•	•		•			
Sensorless control for synchronous motors (SL-PSM)	•	•				•	
Servo control for asynchronous motors (SC-ASM)		•		•			
Torque mode	•	•			•		
<b>Motor functions</b>							
Flying restart circuit	•	•	•				
Slip compensation	•	•	•				
DC braking	•	•	•				
Oscillation damping	•	•	•				
Skip frequencies	•	•	•				
Automatic identification of the motor data	•	•		•			
Brake energy management	•	•	•				
Holding brake control	•	•		•			
Rotational Energy Ride Through (RERT)	•	•		•			
Speed feedback (HTL encoder)		•		•			
Frequency setpoint		•				•	
<b>Application functions</b>							
Process controller	•	•	•				
Parameter change-over	•	•	•				
S-shaped ramps for smooth acceleration	•	•	•				
Motor potentiometer	•	•	•				
Flexible I/O configuration	•	•	•				
Access protection	•	•	•				
Automatic restart	•	•	•				
Sequencer	•	•			•		
Position counter		•			•		
Complete control with 8-key keypad	•	•				•	
UPS operation	•	•					•
Frequency output via digital output DO1	•	•					•
"Light Duty" load characteristic can be adjusted for selected inverters		•					•
<b>Monitoring</b>							
Short circuit, earth fault	•	•	•				
Device overload (I x t)	•	•	•				
Motor overload (I <sup>2</sup> x t)	•	•	•				
Mains phase failure, motor phase failure	•	•	•				
Stalling protection	•	•	•				
Motor current limit	•	•	•				
Maximum torque	•	•	•				
Ultimate motor current	•	•	•				
Motor speed	•	•	•				
Load loss detection	•	•	•				
Motor temperature		•	•				
<b>Diagnostics</b>							
Error history buffer, logbook	•	•	•				
LED status display	•	•	•				

# About Lenze

## Inverter overview



Function	Inverter		Available as of firmware version				
	i510	i550	V1.1	V2.1	V3.0	V4.1	V5.0
Network							
CANopen	•	•	•				
Modbus RTU	•	•	•				
Modbus TCP		•				•	
PROFIBUS		•	•				
EtherCAT		•		•			
EtherNet/IP		•		•			
PROFINET		•		•			
POWERLINK		•					•
Functional safety (optional)							
STO (Safe torque off)		•	•				





## About this document



Information and tools with regard to the Lenze products can be found on the Internet:  
<http://www.lenze.com> → Download

## Document description

This document is aimed at all persons who want to project inverters with the described products.

The data and information compiled here serve to support you in dimensioning and selecting and preparing the electrical and mechanical installation. You will receive information on product extensions and accessories.

## More information

For certain tasks, more information is available in additional documents.

Document	Contents/topics
Commissioning document	Setting and parameterising the inverters
Mounting Instructions	Basic information for the mechanical and electrical installation <ul style="list-style-type: none"><li>• Is supplied with each component.</li></ul>
"Functional safety" configuration document	Information on this (optional) function



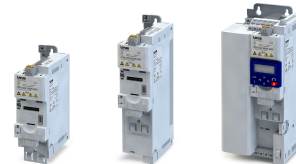

# About this document

## Notations and conventions



### Notations and conventions

This document uses the following conventions to distinguish different types of information:

Numbers			
	Decimal separator	Point	In general, the decimal point is used. Example: 1 234.56
Warning			
	UL warning	UL	Are used in English and French.
	UR warning	UR	
Text			
	Programs	» «	Software Example: »Engineer«, »EASY Starter«
Icons			
	Page reference		Reference to another page with additional information Example:  16 = see page 16
	Documentation reference		Reference to another documentation with additional information Example:  EDKxxx = see documentation EDKxxx

### Layout of the safety instructions

#### **DANGER!**

This note refers to an imminent danger which, if not avoided, may result in death or serious injury.

#### **WARNING!**

This note refers to a danger which, if not avoided, may result in death or serious injury.

#### **CAUTION!**

This note refers to a danger which, if not avoided, may result in minor or moderate injury.

#### **NOTICE**

This note refers to a danger which, if not avoided, may result in damage to material assets.

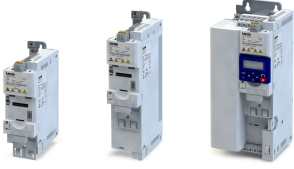

## About this document

Notations and conventions

---



---

# Inverter

Inverter i550 Cabinet 0.25 ... 75 kW

---

**Contents**

<b>Product information</b> .....	<b>17</b>
Product description .....	17
Features.....	18
The modular system .....	23
The concept .....	23
Topologies / network.....	24
Ways of commissioning.....	25
Functions.....	26
Overview.....	26
Motor control types .....	27
Features.....	28
Motor setting range.....	28
The name of the product.....	30
<b>Project planning</b> .....	<b>32</b>
Project planning process.....	32
Dimensioning .....	32
Operation in motor and generator mode.....	35
Overcurrent operation.....	36
Safety instructions .....	38
Application as directed.....	38
Handling.....	39
Residual hazards.....	40
Control cabinet structure.....	41
Arrangement of components.....	41
Cables .....	42
Earthing concept.....	42
EMC-compliant installation .....	43

# Contents

---

<b>Technical data</b> .....	<b>45</b>
Standards and operating conditions.....	45
Conformities/approvals.....	45
Protection of persons and device protection.....	45
EMC data.....	45
Motor connection.....	46
Environmental conditions.....	46
Electrical supply conditions.....	46
1-phase mains connection 120 V.....	47
Rated data.....	47
Fusing and terminal data.....	48
Brake resistors.....	50
Mains chokes.....	50
1-phase mains connection 230/240 V.....	51
Rated data.....	52
Fusing and terminal data.....	56
Brake resistors.....	59
Mains chokes.....	59
RFI filters / Mains filters.....	60
3-phase mains connection 230/240 V.....	62
Rated data.....	63
Fusing and terminal data.....	66
Brake resistors.....	68
Mains chokes.....	68
3-phase mains connection 400 V.....	69
Rated data.....	69
Fusing and terminal data.....	74
Brake resistors.....	79
Mains chokes.....	80
RFI filters / Mains filters.....	81
Sine filter.....	84
3-phase mains connection 400 V "light duty".....	85
Rated data.....	85
Fusing and terminal data.....	89
Brake resistors.....	93
Mains chokes.....	93
RFI filters / Mains filters.....	94
Sine filter.....	95
3-phase mains connection 480 V.....	96
Rated data.....	96
Fusing and terminal data.....	101
Brake resistors.....	106
Mains chokes.....	107
RFI filters / Mains filters.....	108

---

3-phase mains connection 480 V "Light Duty".....	111
Rated data.....	111
Fusing and terminal data.....	115
Brake resistors.....	120
Mains chokes.....	120
RFI filters / Mains filters.....	121
Dimensions.....	122
<b>Product extensions.....</b>	<b>132</b>
Overview.....	132
I/O extensions.....	133
Standard I/O.....	133
Application I/O.....	134
Data of control connections.....	135
More control connections.....	138
Relay output.....	138
PTC input.....	138
Networks.....	139
CANopen.....	139
Modbus RTU.....	141
Modbus TCP.....	143
PROFIBUS.....	145
EtherCAT.....	147
EtherNet/IP.....	149
PROFINET.....	151
POWERLINK.....	153
Functional safety.....	155
Safety module.....	155
<b>Accessories.....</b>	<b>156</b>
Overview.....	156
Operation and diagnostics.....	157
Keypad.....	157
USB module.....	157
WLAN module.....	158
Blanking cover.....	160
Setpoint potentiometer.....	160
Memory modules.....	160
Memory module copier.....	161
Brake resistors.....	161
Mains chokes.....	162
RFI filters / Mains filters.....	163
Sine filter.....	164
Power supply units.....	164
Brake switches.....	165
Mounting.....	166
Shield mounting kit.....	166
Terminal strips.....	167

# Contents

---

<b>Mounting/ installation</b> .....	<b>168</b>
Electrical installation.....	170
Important notes .....	170
Mains connection.....	173
1-phase mains connection 120 V .....	174
1-phase mains connection 230/240 V .....	175
3-phase mains connection 230/240 V .....	177
3-phase mains connection 400 V .....	179
3-phase mains connection 400 V "light duty" .....	179
3-phase mains connection 480 V .....	180
3-phase mains connection 480 V "Light Duty".....	180
Motor connection .....	181
Motor cable lengths.....	181
Shielding.....	181
Switching in the motor cable.....	181
Connection of motor temperature monitoring.....	181
Brake resistor connection .....	182
Control connections .....	183
<b>Purchase order</b> .....	<b>184</b>
Notes on ordering.....	184
Order code.....	185





## Product information

### Product description

i500 is the new inverter series - a streamlined design, scalable functionality and exceptional user-friendliness.

i500 is a high-quality inverter that already conforms to future standard in accordance with the EN 50598-2 efficiency classes (IE). Overall, this provides a reliable and future-proof drive for a wide range of machine applications.

#### The i550

This chapter provides the complete scope of the inverter i550. This inverter is suitable for a very broad use in inverter-operated drives. Basically, the device has the following features:

- All typical motor control types of modern inverters.
- Cyclic and continuous operation of the motor according to common operating modes.
- Industry-standard networking opportunities.
- High internal functional range.

#### Highlights

- Compact size
  - Up to 2.2 kW only 60 mm wide
  - Up to 11 kW only 130 mm deep
- Can be directly connected without external cooling
- Innovative interaction options enable better set-up times than ever.
- The wide-ranging modular system enables various product configurations depending on machine requirements.



#### Application ranges

- Pumps and fans
- Conveying and travelling drives
- Forming, tool and hoist drives

# Product information

## Features



## Features

### Example of 0.25 kW ... 2.2 kW

PE connection

Mains connection X100

DC-bus X100 connection

Relay output X9

IT screw

from 0.55 kW

Network X2xx

Option

Network shield connection

Option

Network status LEDs

Basic network settings

DIP switch or rotary encoder switch

Interface X16

Diagnostic module

Memory module X20

IT screw

Motor connection X105

X105 brake resistor connection

Shield connection

Control connections

Safety module X1

Slot

PTC input X109

Control terminals X3

Standard I/O or Application I/O

Inverter status LEDs





**Example of 3 kW ... 11 kW**

PE connection

Mains connection X100

DC-bus X100 connection

Network X2xx

Option

Network shield connection

Option

Relay output X9

Network status LEDs

Basic network settings

DIP switch or rotary encoder switch

Interface X16

Diagnostic module

Memory module X20

Inverter status LEDs

Control terminals X3

Standard I/O or Application I/O

Shield connection

Control connections

IT screw

Safety module X1

Slot

IT screw

Motor connection X105

X105 brake resistor connection

PTC input X109

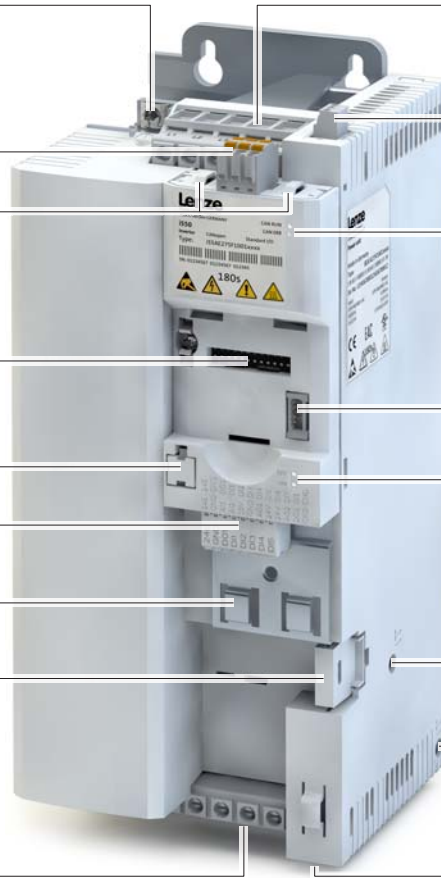

# Product information

## Features



### Example of 15 kW ... 45 kW

**PE connection**

IT screw

**Network X2xx**

Option

**Network shield connection**

Option

**Basic network settings**

DIP switch or rotary encoder switch

**Memory module X20**

**Control terminals X3**

Standard I/O or Application I/O

**Shield connection**

Control connections

**Safety module X1**

Slot

IT screw

**Motor connection X105**

Anschluss Bremswiderstand X105

**Mains connection X100**

Anschluss DC-Bus X100

**Relay output X9**

**Network status LEDs**

**Interface X16**

Diagnostic module

**Inverter status LEDs**

**PTC input X109**

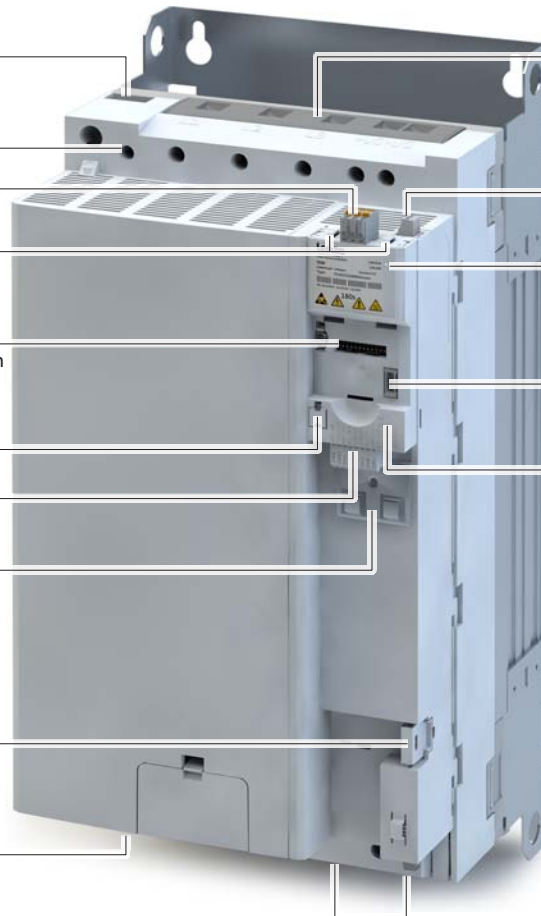



**Example of 55 kW ... 75 kW**

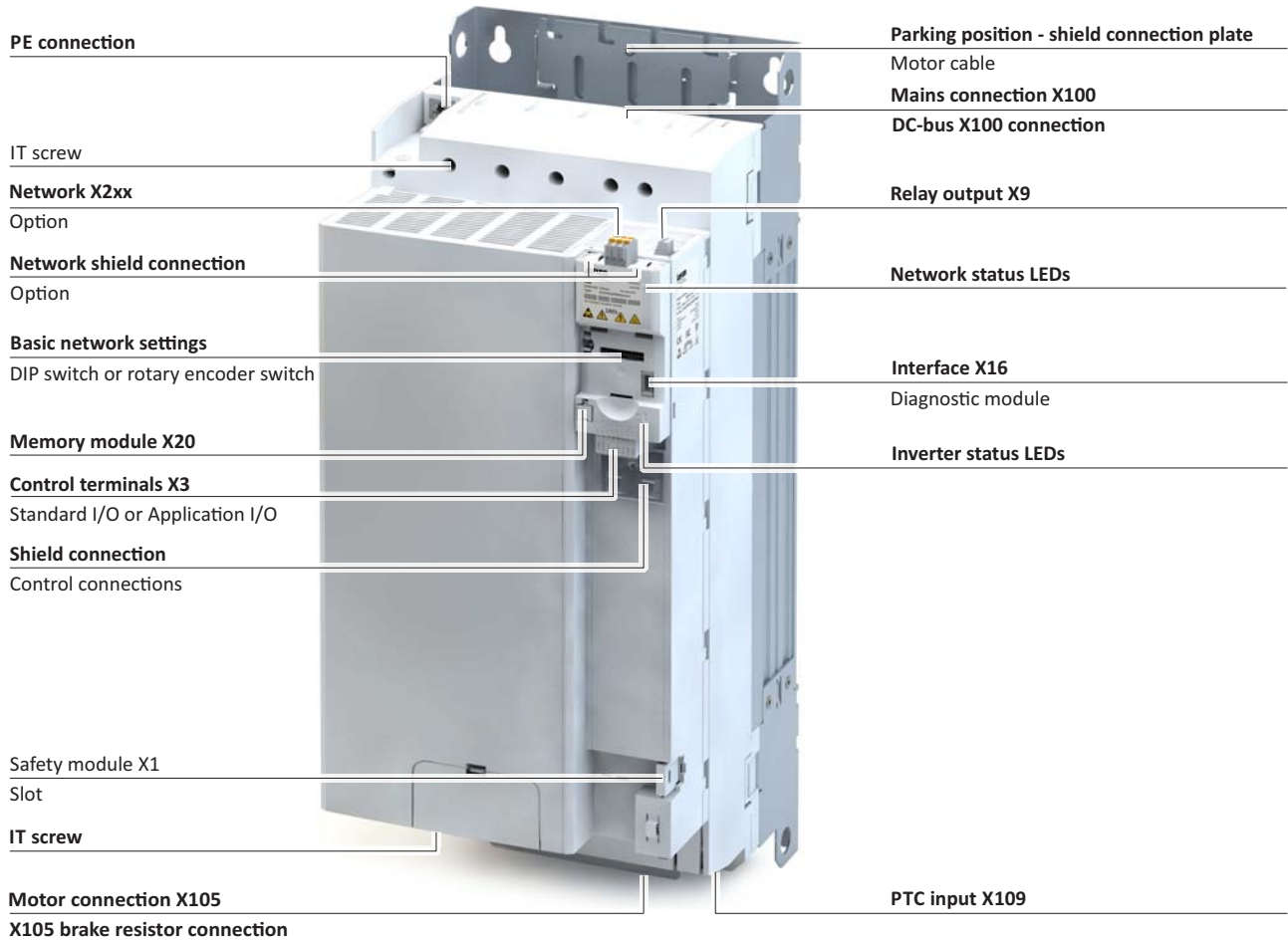

# Product information

## Features



### Position and meaning of the nameplates

Complete inverter		Inverter consisting of components	
①	Technical data of the inverter	①	Technical data of the component
④	Technical data of the control unit Type and serial number of the inverter	②	Type and serial number of the component
		③	Technical data, type and serial number of the safety module



## The modular system

### The concept

Thanks to its flexible concept and modular structure consisting of power unit, control unit and safety module, the inverter can be optimally adapted to the application.

This provides the user with a flexible logistics concept - ordered as a complete inverter or single components.

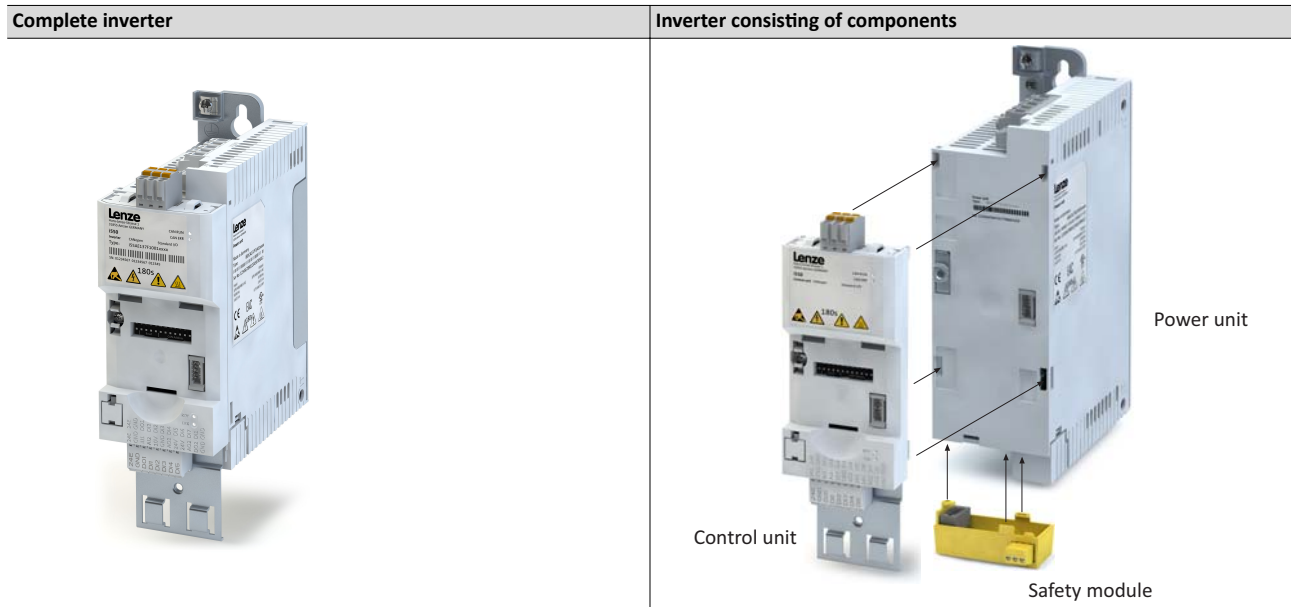

### Power unit

The power unit is the power section of the inverter.

It is available in the power range from 0.25 kW to 75 kW.

### Control unit

The control unit is the open and closed-loop control unit.

It contains I/O connections, an optional network, the interface for diagnostic modules, LED status displays and the memory module.

### Safety module

The optional safety module is available with the functional safety STO (Safe torque off).

# Product information

The modular system  
Topologies / network



## Topologies / network

The inverters can be equipped with different fieldbus networks.

The topologies and protocols typical for the prevailing networks are supported.

Currently available networks:

	<p>CANopen® is a communication protocol based on CAN. CANopen® is a registered community trademark of the CAN user organisation CiA® (CAN in Automation e. V.). Device descriptions for the download: EDS files for Lenze devices</p>
	<p>The Modbus protocol is an open communication protocol based on a client/server architecture and developed for the communication with programmable logic controllers. The further development is carried out by the international user organisation Modbus Organization, USA.</p>
	<p>PROFIBUS® (Process Field Bus) is a widely-used fieldbus system for the automation of machines and production plants. PROFIBUS® is a registered trademark and patented technology licensed by the PROFIBUS &amp; PROFINET International (PI) user organisation. Device descriptions for the download: GSD files for Lenze devices</p>
	<p>EtherCAT® (Ethernet for Controller and Automation Technology) is an Ethernet-based fieldbus system which fulfils the application profile for industrial realtime systems EtherCAT® is a registered trademark and patented technology, licensed by Beckhoff Automation GmbH, Germany. Device descriptions for the download: XML/ESI files for Lenze devices</p>
	<p>EtherNet/IP™ (EtherNet Industrial Protocol) is a fieldbus system based on Ethernet which uses the Common Industrial Protocol™ (CIP™) for data exchange. EtherNet/IP™ and Common Industrial Protocol™ (CIP™) are trademarks and patented technologies, licensed by the user organisation ODVA (Open DeviceNet Vendor Association), USA. Device descriptions for the download: EDS files for Lenze devices</p>
	<p>PROFINET® (Process Field Network) is a real-time capable fieldbus system based on Ethernet. PROFINET® is a registered trademark and patented technology licensed by the PROFIBUS &amp; PROFINET International (PI) user organisation. Device descriptions for the download: GSDML files for Lenze devices</p>
	<p>Ethernet POWERLINK is and Ethernet-based fieldbus system which fulfils the application profile for industrial real-time systems. POWERLINK is an open technology. Detailed information on POWERLINK can be found on the web page of the Ethernet POWERLINK Standardization Group (EPSG): <a href="http://www.ethernet-powerlink.org">http://www.ethernet-powerlink.org</a></p>

More information on the supported networks can be found at <http://www.lenze.com>





## Product information

The modular system  
Ways of commissioning

### Ways of commissioning

There are three methods to commission the inverter quickly and easily.

Thanks to Lenze's engineering philosophy, the high functionality is still easy to grasp. Parameterisation and set-up are impressive thanks to clear structure and simple dialogues, leading to the desired outcome quickly and reliably.

- Keypad  
If it's only a matter of setting a few key parameters such as acceleration and deceleration time, this can be done quickly on the keypad.



- Smart-Keypad-App for Android  
The intuitive smartphone app enables adjustment to a simple application such as a conveyor belt.

The Lenze Smart keypad app can be found in the Google Play Store.

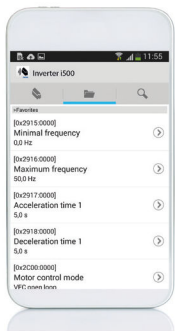

- »EASY Starter«  
If functions such as the holding brake control or sequencer need to be set, it's best to use the »EASY Starter« engineering tool.



# Product information

Functions  
Overview



## Functions

### Overview

With regard to their functionality, the inverters i550 are adapted to extensive applications. This is also reflected in the total scope of the products.

Functions	
Motor control	Monitoring
V/f characteristic control linear/square-law (VFC plus)	Short circuit
V/f characteristic control (VFC closed loop)	earth fault
Energy saving function (VFC-ECO)	Device overload ( $i^*t$ )
Sensorless vector control (SLVC)	Motor overload ( $i^2*t$ )
Sensorless control for synchronous motors (SL-PSM) (up to 22 kW, from 30 kW ... 75 kW: in preparation)	Mains phase failure
Servo control for asynchronous motors (SC-ASM)	Stalling protection
Motor functions	Motor current limit
Flying restart circuit	Maximum torque
Slip compensation	Ultimate motor current
DC braking	Motor speed
Oscillation damping	Load loss detection
Skip frequencies	Motor temperature
Automatic identification of the motor data	Diagnostics
Brake energy management	Error history buffer
Holding brake control	Logbook
Voltage add – function	LED status display
Rotational Energy Ride Through (RERT)	Keypad language selection German, English
Speed feedback (HTL encoder)	Network
Brake resistor control (brake chopper integrated)	CANopen
Frequency setpoint	Modbus RTU
DC-bus connection (400V devices)	Modbus TCP
Application functions	PROFIBUS
Process controller	EtherCAT
Access protection	EtherNet/IP
Process controller - idle state and rinse function	PROFINET
Freely assignable favourite menu	POWERLINK
Parameter change-over	Safety functions
S-shaped ramps for smooth acceleration	STO (Safe torque off)
Motor potentiometer	
Flexible I/O configuration	
Automatic restart	
OEM parameter set	
Complete control with 8-key keypad	
UPS operation	
Frequency output via digital output DO1	
"Light Duty" load characteristic can be adjusted for selected inverters	



## Motor control types

The following table contains the possible control types with Lenze motors.

Motors	V/f characteristic control VFCplus	Sensorless vector control SLVC	ASM servo control SC ASM
Three-phase AC motors			
MD	•	•	•
MF	•	•	•
mH	•	•	•
m500	•	•	•

Lenze synchronous servo motors are not suitable for the use with inverters, e. g. the MCS, MCM or m850 types.

# Product information

Features  
Motor setting range



## Features

### Motor setting range

#### Rated point 120 Hz



Only possible with Lenze MF motors.

The rated motor torque is available up to 120 Hz.

Compared to the 50-Hz operation, the setting range increases by 2.5 times.

Thus, a smaller motor can be selected at the same rated power.

#### V/f at 120 Hz

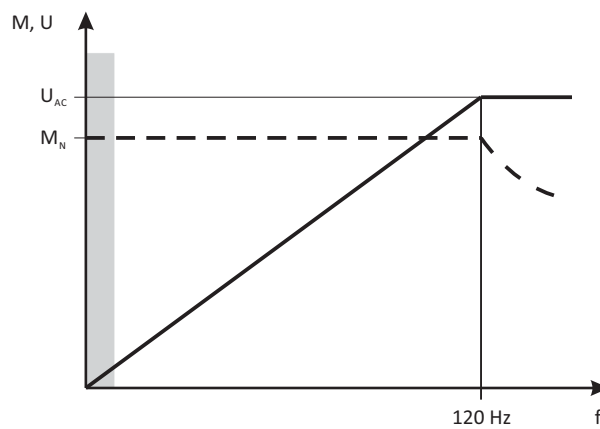

V Voltage  
M Torque  
f Frequency

$U_{AC}$  Mains voltage  
 $M_{rated}$  Rated torque

#### Rated point 87 Hz

The rated motor torque is available up to 87 Hz.

Compared to the 50-Hz operation, the setting range increases by 1.74 times.

For this purpose, a motor with 230/400 V in star connection is driven by a 400-V inverter.

The inverter must be dimensioned for a rated motor current of 230 V.



**V/f at 87 Hz**

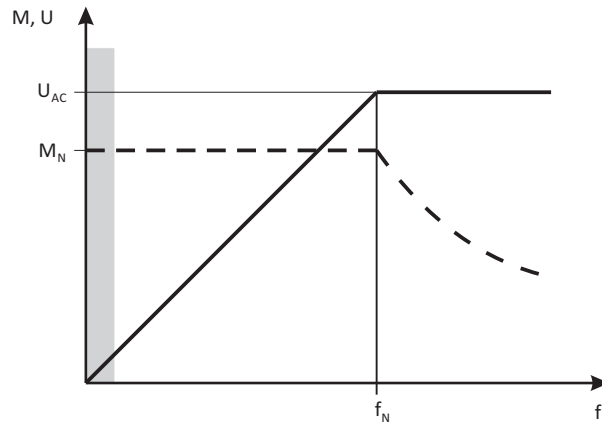

V Voltage  
M Torque  
f Frequency

$U_{AC}$  Mains voltage  
 $M_{rated}$  Rated torque  
 $f_{rated}$  Rated frequency

**Rated point 50 Hz**

The rated motor torque is available up to 50 Hz.

**V/f at 50 Hz**

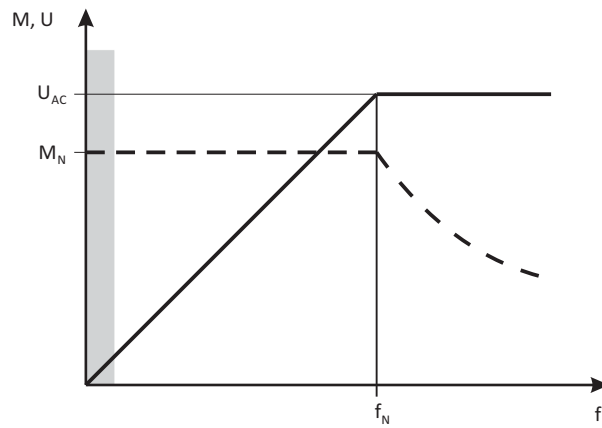

V Voltage  
M Torque  
f Frequency

$U_{AC}$  Mains voltage  
 $M_{rated}$  Rated torque  
 $f_{rated}$  Rated frequency

# Product information

The name of the product

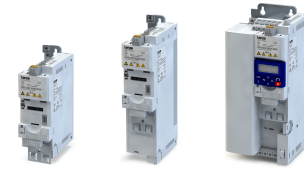

## The name of the product

When the technical data of the different versions were listed, the product name was entered because it is easier to read than the individual type code of the product. The product name is also used for the accessories. The assignment of product name and order code can be found in the Order chapter.

The product name contains the power in kW, the mains voltage class 120 V, 230 V or 400 V and the number of phases.

In the product name, the power information always refers to the "Heavy Duty" load characteristic.

The 1/3-phase inverters are marked at the end with "-2".

"C" marks the "Cabinet" version = inverter for the installation into the control cabinet.

In tables, the first 9 digits of the corresponding product code are used to identify the products:

### 1-phase mains connection 120 V

Inverter series	Type	Rated power	Rated mains voltage	Number of phases	Product name
		kW	V		
i550	C	0.25	120	1	i550-C0.25/120-1
		0.37			i550-C0.37/120-1
		0.75			i550-C0.75/120-1
		1.1			i550-C1.1/120-1

### 1-phase mains connection 230/240 V

Inverter series	Type	Rated power	Rated mains voltage	Number of phases	Product name
		kW	V		
i550	C	0.25	230	1	i550-C0.25/230-1
				1/3	i550-C0.25/230-2
		0.37		1	i550-C0.37/230-1
				1/3	i550-C0.37/230-2
		0.55		1	i550-C0.55/230-1
				1/3	i550-C0.55/230-2
		0.75		1	i550-C0.75/230-1
				1/3	i550-C0.75/230-2
		1.1		1	i550-C1.1/230-1
				1/3	i550-C1.1/230-2
		1.5		1	i550-C1.5/230-1
				1/3	i550-C1.5/230-2
		2.2		1	i550-C2.2/230-1
				1/3	i550-C2.2/230-2

### 3-phase mains connection 230/240 V

Inverter series	Type	Rated power	Rated mains voltage	Number of phases	Product name
		kW	V		
i550	C	0.25	240	1/3	i550-C0.25/230-2
		0.37			i550-C0.37/230-2
		0.55			i550-C0.55/230-2
		0.75			i550-C0.75/230-2
		1.1			i550-C1.1/230-2
		1.5			i550-C1.5/230-2
		2.2			i550-C2.2/230-2
		4			i550-C4.0/230-3
		5.5		i550-C5.5/230-3	



# Product information

The name of the product

## 3-phase mains connection 400 V

Inverter series	Type	Rated power		Rated mains voltage	Number of phases	Product name
		Light duty	Heavy Duty			
		kW	kW			
i550	C	-	0.37	400	3	i550-C0.37/400-3
			0.55			i550-C0.55/400-3
			0.75			i550-C0.75/400-3
			1.1			i550-C1.1/400-3
			1.5			i550-C1.5/400-3
			2.2			i550-C2.2/400-3
		4	3			i550-C3.0/400-3
		5.5	4			i550-C4.0/400-3
		7.5	5.5			i550-C5.5/400-3
		11	7.5			i550-C7.5/400-3
		15	11			i550-C11/400-3
		18.5	15			i550-C15/400-3
		22	18.5			i550-C18/400-3
		30	22			i550-C22/400-3
		37	30			i550-C30/400-3
		45	37			i550-C37/400-3
		55	45			i550-C45/400-3
		75	55			i550-C55/400-3
90	75	i550-C75/400-3				

## 3-phase mains connection 480 V

Inverter series	Type	Rated power		Rated mains voltage	Number of phases	Product name
		Light duty	Heavy Duty			
		kW	kW			
i550	C	-	0.37	480	3	i550-C0.37/400-3
			0.55			i550-C0.55/400-3
			0.75			i550-C0.75/400-3
			1.1			i550-C1.1/400-3
			1.5			i550-C1.5/400-3
			2.2			i550-C2.2/400-3
		4	3			i550-C3.0/400-3
		5.5	4			i550-C4.0/400-3
		7.5	5.5			i550-C5.5/400-3
		11	7.5			i550-C7.5/400-3
		15	11			i550-C11/400-3
		18.5	15			i550-C15/400-3
		22	18.5			i550-C18/400-3
		30	22			i550-C22/400-3
		37	30			i550-C30/400-3
		45	37			i550-C37/400-3
		55	45			i550-C45/400-3
		75	55			i550-C55/400-3
90	75	i550-C75/400-3				

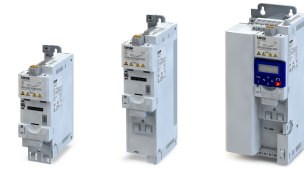

## Project planning

### Project planning process

#### Dimensioning

#### 3 methods for dimensioning

**Fast:** Selection of the inverter based on the motor data of a 4-pole asynchronous motor.

**Detailed:** In order to optimise the selection of the inverter and all drive components, it is worth to execute the detailed system dimensioning based on the physical requirements of the application. For this purpose, Lenze provides the «Drive Solution Designer» (DSD) design program.

**Manual:** The following chapter guides you step by step to the selection of a drive system.

#### Workflow of a configuration process

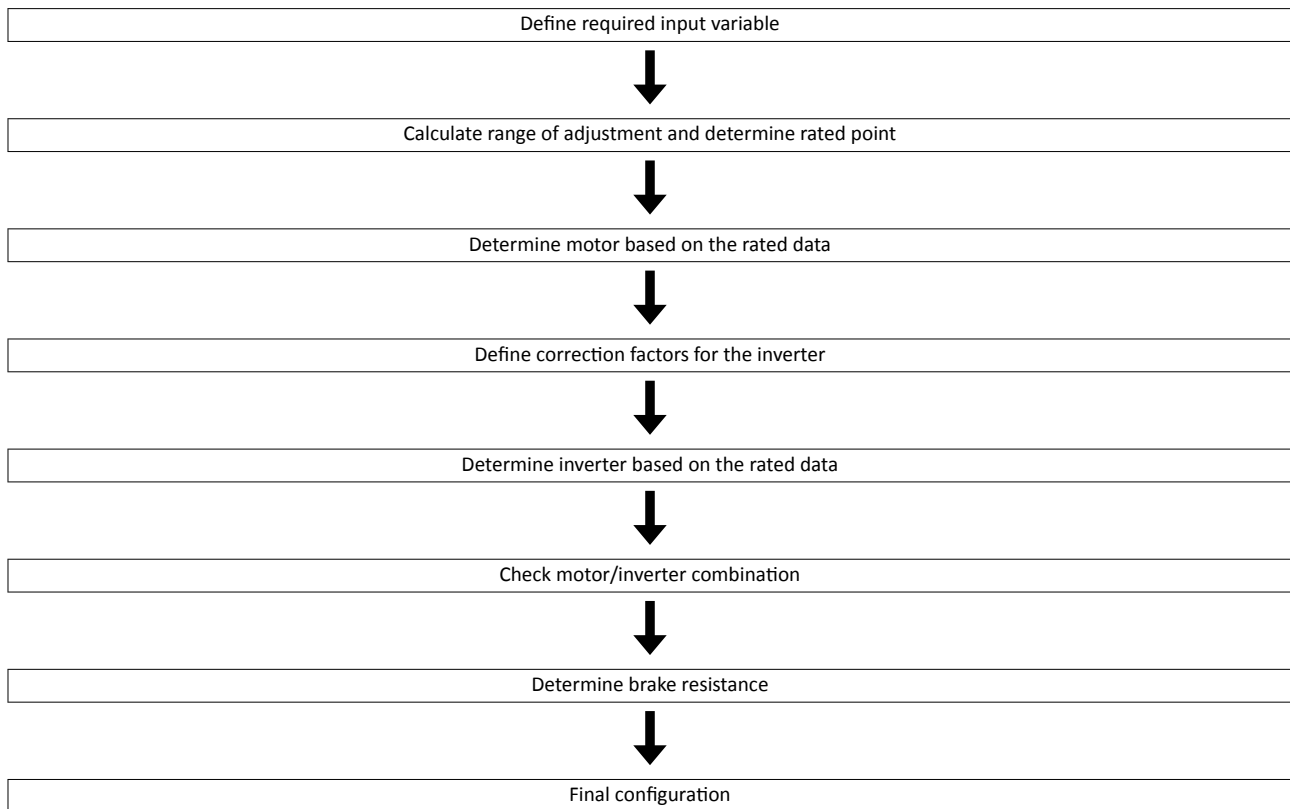

#### Define required input variables

Operating mode			S1 or S6
Max. load torque	$M_{L,max}$	Nm	
Max. load speed	$n_{L,max}$	rpm	
Min. load speed	$n_{L,min}$	rpm	
Site altitude	H	m	
Temperature in the control cabinet	$T_U$	°C	





### Calculate range of adjustment and determine rated point

	Calculation
Setting range	$V = \frac{n_{L,max}}{n_{L,min}}$

	Setting range	Rated point
Motor with integral fan	≤ 2.50 (20 - 50 Hz)	50 Hz
	≤ 4.35 (20 - 87Hz)	87 Hz
	≤ 6 (20 - 120Hz)	120 Hz
Motor with blower	≤ 10.0 (5 - 50 Hz)	50 Hz
Motor with integral fan (reduced torque)	≤ 17.4 (5 - 87Hz)	87 Hz
	≤ 24 (5 - 120Hz)	120 Hz

### Determine motor based on the rated data

			Check
Rated torque			
Operating mode S1	$M_{rated}$	Nm	$M_N \geq \frac{M_{L,max}}{T_{H,Mot} \times T_{U,Mot}}$
Operating mode S6	$M_{rated}$	Nm	$M_N \geq \frac{M_{L,max}}{2 \times T_{H,Mot} \times T_{U,Mot}}$
Rated speed	$n_{rated}$	rpm	$n_{rated} \geq n_{L,max}$ $\frac{n_n}{V} \leq n_{L,min}$

			Note
Rated torque	$M_{rated}$	Nm	→ Rated motor data
Rated speed	$n_{rated}$	rpm	
Rated point at		Hz	→ setting range
Power factor	$\cos \varphi$		→ Rated motor data
Rated current	$I_{N,MOT}$	A	
Rated power	$P_{rated}$	kW	
Correction factor - site altitude	$T_{H,MOT}$		→ Technical motor data
Correction factor - ambient temperature	$T_{U,MOT}$		
Select motor			

### Correction factors for the inverter

Site altitude Amsl	H			
[m]	≤ 1000	≤ 2000	≤ 3000	≤ 4000
$k_{H,INV}$	1.00	0.95	0.90	0.85

Temperature in the control cabinet	$T_U$			
[°C]	≤ 40	≤ 45	≤ 50	≤ 55

Switching frequency		$T_U$			
2 or 4 kHz	$k_{TU,INV}$	≤ 40	≤ 45	≤ 50	≤ 55
8 or 16 kHz		1.00	0.875	0.750	0.625

Switching frequency with the "Light Duty" load characteristic		$T_U$			
2 or 4 kHz	$k_{TU,INV}$	≤ 40	≤ 45	≤ 50	≤ 55
8 or 16 kHz		-	-	-	-

### Determine inverter based on the rated data

			Check
Output current			
Continuous operation	$I_{out}$	A	$I_{out} \geq I_{N,Mot} / (k_{H,INV} \times k_{TU,INV})$
Overcurrent operation cycle 15 s	$I_{out}$	A	$I_{out} \geq I_{N,Mot} \times 2 / (k_{H,INV} \times k_{TU,INV})$
Overcurrent operation cycle 180 s	$I_{out}$	A	$I_{out} \geq I_{N,Mot} \times 1.5 / (k_{H,INV} \times k_{TU,INV})$

# Project planning

Project planning process  
Dimensioning



## Determine the inverter based on the rated data for the "Light Duty" load characteristic

			Check
Output current			
Continuous operation	$I_{out}$	A	$I_{out} \geq I_{N,Mot} / (k_{H,INV} \times k_{TU,INV})$
Overcurrent operation cycle 15 s	$I_{out}$	A	$I_{out} \geq I_{N,Mot} \times 1.65 / (k_{H,INV} \times k_{TU,INV})$
Overcurrent operation cycle 180 s	$I_{out}$	A	$I_{out} \geq I_{N,Mot} \times 1.25 / (k_{H,INV} \times k_{TU,INV})$

## Check motor/inverter combination

			Calculation
Motor torque	M	Nm	$M = \sqrt{\left(\frac{I_{out,INV}}{I_{N,MOT}}\right)^2 - (1 - \cos\varphi^2)} \times \frac{M_N}{\cos\varphi}$

			Check
Overload capacity of the inverter			$\frac{M_{L,max}}{M} \leq 1.5$

## Braking operation without additional measures

To decelerate small masses, the "DC injection brake DCB" function can be parameterised. DC-injection braking enables a quick deceleration of the drive to standstill without the need for an external brake resistor.

- A code can be used to select the braking current.
- The maximum braking torque to be realised by the DC braking current amounts to approx. 20 ... 30 % of the rated motor torque. It is lower compared to braking action in generator mode with external brake resistor.
- Automatic DC-injection braking (Auto-DCB) improves the starting performance of the motor when the operation mode without speed feedback is used.

## Braking operation with external brake resistor

To decelerate greater moments of inertia or with a longer operation in generator mode an external brake resistor is required. It converts braking energy into heat.

The brake resistor is connected if the DC-bus voltage exceeds the switching threshold. überschreitet. This prevents the controller from setting pulse inhibit through the "Overvoltage" fault and the drive from coasting. The external brake resistor serves to control the braking process at any time.

The brake chopper integrated in the controller connects the external brake resistor.

## Determine brake resistance

			Application	
			With active load	With passive load
Rated power	$P_{rated}$	kW	$P_N \geq P_{max} \times \eta_e \times \eta_m \times \frac{t_1}{t_2}$	$P_N \geq \frac{P_{max} \times \eta_e \times \eta_m \times t_1}{2} \times \frac{t_1}{t_2}$
Thermal capacity	$C_{th}$	kWs	$C_{th} \geq P_{max} \times \eta_e \times \eta_m \times t_1$	$C_{th} \geq \frac{P_{max} \times \eta_e \times \eta_m \times t_1}{2}$
Rated resistance	$R_{rated}$	$\Omega$	$R_N \geq \frac{U_{DC}^2}{P_{max} \times \eta_e \times \eta_m}$	

- Active load Can start to move independent of the drive (e.g. unwinder)
- Passive load Can stop independent of the drive (e.g. horizontal travelling drives, centrifuges, fans)
- $U_{DC}$  [V] Switching threshold - brake chopper
- $P_{max}$  [W] Maximum occurring braking power
- $\eta_e$  Electrical efficiency
- $\eta_m$  Mechanical efficiency
- $t_1$  [s] Braking time
- $t_2$  [s] Cycle time = time between two successive braking processes ( $t_1$  + dead time)



## Final configuration

Product extensions and accessories can be found here:

- [Product extensions](#)  132
- [Accessories](#)  156

## Operation in motor and generator mode

The energy analysis differs between operation in motor mode and generator mode.

During operation in motor mode, the energy flows from the supplying mains via the inverter to the motor which converts electrical energy into mechanical energy (e. g. for lifting a load).

During operation in generator mode, the energy flows back from the motor to the inverter. The motor converts the mechanical energy into electrical energy - it acts as a generator (e. g. when lowering a load).

The drive brakes the load in a controlled manner.

The energy recovery causes a rise in the DC-bus voltage. If this voltage exceeds an upper limit, the output stage of the inverter will be blocked to prevent the device from being destroyed.

The drive coasts until the DC-bus voltage reaches the permissible value range again.

In order that the excessive energy can be dissipated, a brake resistor or a regenerative module is required.

# Project planning

Project planning process  
Overcurrent operation



## Overcurrent operation

The inverters can be driven at higher amperages beyond the rated current if the duration of this overcurrent operation is time limited.

Two utilisation cycles of 15 s and 180 s are defined. Within these utilisation cycles, an overcurrent is possible for a certain time if afterwards an accordingly long recovery phase takes place.

### Cycle 15 s

During this operation, the inverter may be loaded for 3 s with up to 200 % of the rated current if afterwards a recovery time of 12 s with max. 75 % of the rated current is observed. A cycle corresponds to 15 s.

### Cycle 180 s

During this operation, the inverter may be loaded for 60 s with up to 150 % of the rated current if afterwards a recovery time of 120 s with max. 75 % of the rated current is observed. A cycle corresponds to 180 s.

The monitoring of the device utilisation ( $I_{xt}$ ) causes the set error response if one of the two utilisation values exceeds the threshold of 100 %.



The maximum output currents correspond to the switching frequencies and the overload behaviour of the inverters are given in the rated data.

In case of rotating frequencies < 10 Hz, the time-related overload behaviour may be reduced.

The graphics shows a cycle. The basic conditions given in the table (graphics field highlighted in grey) have to be complied with in order that the inverter will not be overloaded. Both cycles can be combined with each other.

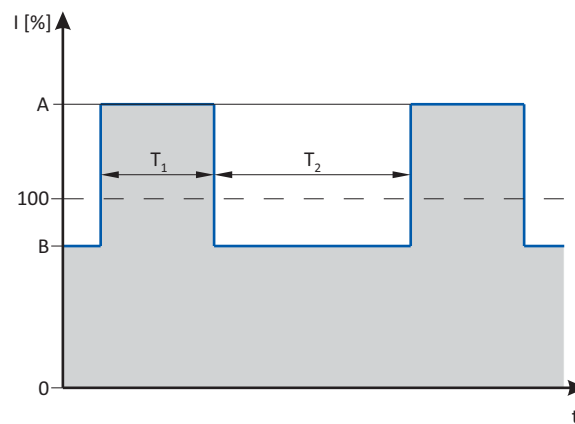

	Max. output current	Max. overload time	Max. output current during the recovery time	Min. recovery time
	A	$T_1$	B	$T_2$
	%	s	%	s
Cycle 15 s	200	3	75	12
Cycle 180 s	150	60	75	120



## Inverter load characteristics

The inverter has two different load characteristics: "Light Duty" and "Heavy Duty". The "Light Duty" load characteristic allows for a higher output current with restrictions regarding overload capacity, ambient temperature and switching frequency. This allows the motor required for the application to be driven by a less powerful inverter. Select the load characteristic according to the application.

## Heavy Duty compared to Light Duty

The table compares both possible configurations:

	Heavy Duty	Light duty
Characteristics	High dynamic requirements	Low dynamic requirements
Typical applications	Main tool drives, travelling drives, hoist drives, winders, forming drives and conveyors	Pumps, fans, general horizontal materials handling technology and line drives
Overload capacity	3 s/200 %, 60 s/150 % see technical data	restricted see technical data

Devices with Light Duty load characteristic: See [85](#), [111](#)



### "Light Duty" load characteristic

In order to avoid irreversible damages of the inverter/motor:

- Check whether the inverter can be operated with the "Light Duty" load characteristic.
- Comply with all data for this load characteristic and the corresponding mains voltage range. This comprises, among other things, the information on the type of installation as well as the required fuses, cable cross-sections, mains chokes and filters.
- Set parameters only in accordance with specifications.

# Project planning

Safety instructions  
Application as directed

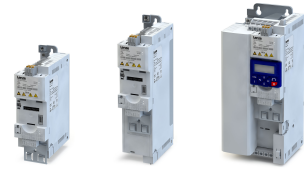

---

## Safety instructions

Disregarding the following basic safety measures and safety information may lead to severe personal injury and damage to property!

Observe all specifications of the corresponding documentation supplied. This is the precondition for safe and trouble-free operation and for obtaining the product features specified.

Please observe the specific safety information in the other sections!

## Application as directed

- The product must only be operated under the operating conditions prescribed in this documentation.
- The product meets the protection requirements of 2014/35/EU: Low-Voltage Directive 2014/35/EU: Low-Voltage Directive.
- The product is not a machine in terms of 2006/42/EC: Machinery Directive 2006/42/EC: Machinery Directive.
- Commissioning or starting the operation as directed of a machine with the product is not permitted until it has been ensured that the machine meets the regulations of the EC Directive 2006/42/EC: Machinery Directive 2006/42/EC: Machinery Directive; observe EN 60204-1 EN 60204-1.
- Commissioning or starting the operation as directed is only allowed when there is compliance with the EMC Directive 2014/30/EU 2014/30/EU.
- The harmonised standard EN 61800-5-1 EN 61800-5-1 is used for the inverters.
- The product is not a household appliance, but is only designed as component for commercial or professional use in terms of EN 61000-3-2 EN 61000-3-2.
- The product can be used according to the technical data if drive systems have to comply with categories according to EN 61800-3 EN 61800-3.

In residential areas, the product may cause EMC interferences. The operator is responsible for taking interference suppression measures.

- The product must only be actuated with motors that are suitable for the operation with inverters.
  - Lenze L-force motors meet the requirements
  - Exception: m240 motors are designed for mains operation only.



---

## Handling

### Transport, storage

Observe the notes regarding transport, storage and correct handling. Ensure proper handling and avoid mechanical stress. Do not bend any components and do not change any insulation distances during transport or handling. Do not touch any electronic components and contacts. Inverters contain electrostatically sensitive components which can easily be damaged by inappropriate handling. Do not damage or destroy any electrical components since thereby your health could be endangered!

### Installation

The technical data and supply conditions can be obtained from the nameplate and the documentation. They must be strictly observed.

The inverters have to be installed and cooled according to the regulations given in the corresponding documentation. Observe the climatic conditions according to the technical data. The ambient air must not exceed the degree of pollution 2 according to EN 61800-5-1/EN 61800-5-1.

### Electrical connection

When working on live inverters, observe the applicable national regulations for the prevention of accidents.

The electrical installation must be carried out according to the appropriate regulations (e. g. cable cross-sections, fuses, PE connection). Additional information can be obtained from the documentation.

This documentation contains information on installation in compliance with EMC (shielding, earthing, filter, and cables). These notes must also be observed for CE-marked inverters. The manufacturer of the system is responsible for compliance with the limit values demanded by EMC legislation. The inverters must be installed in housings (e. g. control cabinets) to meet the limit values for radio interferences valid at the site of installation. The housings must enable an EMC-compliant installation. Observe in particular that e. g. the control cabinet doors have a circumferential metal connection to the housing. Reduce housing openings and cutouts to a minimum.

Inverters may cause a DC current in the PE conductor. If a residual current device (RCD) is used for protection against direct or indirect contact for an inverter with three-phase supply, only a residual current device (RCD) of type B is permissible on the supply side of the inverter. If the inverter has a single-phase supply, a residual current device (RCD) of type A is also permissible. Apart from using a residual current device (RCD), other protective measures can be taken as well, e. g. electrical isolation by double or reinforced insulation or isolation from the supply system by means of a transformer.

### Operation

If necessary, systems including inverters must be equipped with additional monitoring and protection devices according to the valid safety regulations.

After the inverter has been disconnected from the supply voltage, all live components and power terminals must not be touched immediately because capacitors can still be charged. Please observe the corresponding stickers on the inverter.

All protection covers and doors must be shut during operation.

You may adapt the inverters to your application by parameter setting within the limits available. For this, observe the notes in the documentation.

### Safety functions

Certain inverter versions support safety functions (e. g. "safe torque off", formerly "safe standstill") according to the requirements of the EC Machinery Directive 2006/42/EC. The notes on the integrated safety provided in this documentation must be observed.

### Maintenance and servicing

The inverters do not require any maintenance if the prescribed operating conditions are observed.

# Project planning

Safety instructions  
Residual hazards



---

## Disposal

In accordance with the current provisions, inverters and accessories have to be disposed of by means of professional recycling. Inverters contain recyclable raw material such as metal, plastics and electronic components.

## Residual hazards

Even if notes given are taken into consideration and protective measures are implemented, the occurrence of residual risks cannot be fully prevented.

The user must take the residual hazards mentioned into consideration in the risk assessment for his/her machine/system.

If the above is disregarded, this can lead to severe injuries to persons and damage to property!

## Protection of persons

Before working on the inverter, check if no voltage is applied to the power terminals.

- Depending on the device, the power terminals X105 remain live for up to 3 ... 20 minutes.
- The power terminals X100 and X105 remain live even when the motor is stopped.

## Motor protection

With some settings of the inverter, the connected motor can be overheated.

- E. g. by longer operation of self-ventilated motors at low speed.
- E. g. by longer operation of the DC-injection brake.

## Protection of the machine/system

Drives can reach dangerous overspeeds.

- E. g. by setting high output frequencies in connection with motors and machines not suitable for this purpose.
- The inverters do not provide protection against such operating conditions. For this purpose, use additional components.

Switch contactors in the motor cable only if the controller is inhibited.

- Switching while the inverter is enabled is only permissible if no monitoring functions are activated.

## Motor

If there is a short circuit of two power transistors, a residual movement of up to  $180^\circ$ /number of pole pairs can occur at the motor! (For 4-pole motor: residual movement max.  $180^\circ/2 = 90^\circ$ ).

## Parameter set transfer

During the parameter set transfer, control terminals of the inverters can adopt undefined states.

- Thus, the control terminal of the digital input signals have to be removed before the transfer.
- This ensures that the inverter is inhibited. The control terminals are in a defined state.





## Control cabinet structure

### Control cabinet requirements

- Protection against electromagnetic interferences
- Compliance with the ambient conditions of the installed components

### Mounting plate requirements

- The mounting plate must be electrically conductive.
  - Use zinc-coated mounting plates or mounting plates made of V2A.
  - Varnished mounting plates are unsuitable, even if the varnish is removed from the contact surfaces.
- When using several mounting plates, make a conductive connection over a large surface (e. g. using grounding strips).

### Arrangement of components

- Division into power and control areas

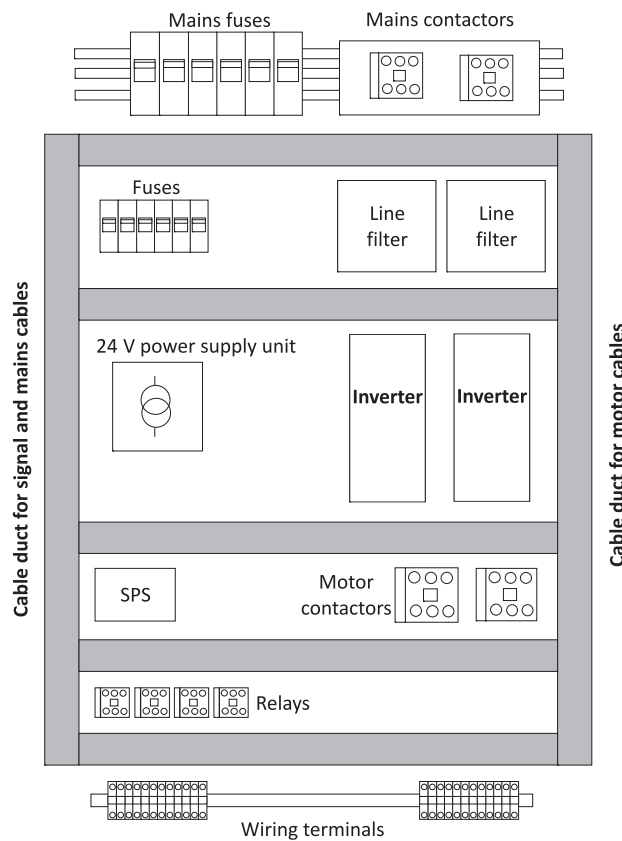
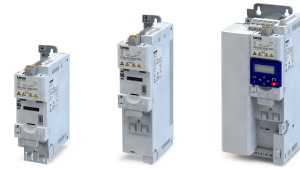

Fig. 1: Example for the ideal arrangement of components in the control cabinet

# Project planning

Control cabinet structure  
Earthing concept



---

## Cables

### Requirements

- The cables used must correspond to the requirements at the location (e. g. EN 60204–1/EN 60204–1, UL).
- The cable cross-section must be dimensioned for the assigned fusing. Observe national and regional regulations.
- You must observe the regulations for minimum cross-sections of PE conductors. The cross-section of the PE conductor must be at least as large as the cross-section of the power connections.

### Installation inside the control cabinet

- Always install cables close to the mounting plate (reference potential), as freely suspended cables act like aerials.
- Use separated cable channels for motor cables and control cables. Do not mix up different cable types in one cable channel.
- Lead the cables to the terminals in a straight line (avoid tangles of cables).
- Minimise coupling capacities and coupling inductances by avoiding unnecessary cable lengths and reserve loops.
- Short-circuit unused cores to the reference potential.
- Install the cables of a 24 V DC supply (positive and negative cable) close to each other or twisted over the entire length to avoid loops.

### Installation outside the control cabinet

- In the case of greater cable lengths, a greater cable distance between the cables is required.
- In the case of parallel routing (cable trays) of cables with different types of signals, the degree of interference can be minimised by using a metallic cable separator or isolated cable ducts.

## Earthing concept

- Set up the earthing system with a star topology.
- Connect all components (inverters, filters, chokes) to a central earthing point (PE rail).
- Comply with the corresponding minimum cross-sections of the cables.
- When using several mounting plates, make a conductive connection over a large surface (e. g. using grounding strips).



### EMC-compliant installation

Structure of a CE-typical drive system

The drive system (frequency inverter and drive) corresponds to 2014/30/EU: EMC Directive if it is installed according to the specifications of the CE-typical drive system.

The structure in the control cabinet must support the EMC-compliant installation with shielded cables.

- Please use highly conductive shield connections.
- Connect the housing with shielding effect to the grounded mounting plate with a surface as large as possible, e. g. of inverters and RFI filters.
- Use central earthing points.

Matching accessories makes effective shielding easier.

- Shield sheets
- Shield clips/shield clamps
- Metallic cable ties

### Mains connection, DC supply

- Inverters, mains chokes, or mains filters may only be connected to the mains via unshielded single cores or unshielded cables.
- When a line filter is used, shield the cable between mains filter or RFI filter and inverter if its length exceeds 300 mm. Unshielded cores must be twisted.
- In DC-bus operation or DC supply, use shielded cables.
  - Only certain inverters are provided with this connection facility.

### Voltages for the DC-bus operation

Voltage on the motor side $V_{AC}$	DC supply $V_{DC}$	Voltage range $V_{DC}$	
400	565	480 - 0 % ... 622 + 0 %	2/PE
480	675	577 - 0 % ... 747 + 0 %	

# Project planning

Control cabinet structure  
EMC-compliant installation



## Motor cable

- Only use low-capacitance and shielded motor cables with braid made of tinned or nickel-plated copper.
  - The overlap rate of the braid must be at least 70 % with an overlap angle of 90 °.
  - Shields made of steel braids are not suitable.
- Shield the cable for motor temperature monitoring (PTC or thermal contact) and install it separately from the motor cable.
  - In Lenze system cables, the cable for brake control is integrated into the motor cable. If this cable is not required for brake control, it can also be used to connect the motor temperature monitoring up to a length of 50 m.
  - Only certain inverters are provided with this connection facility.
- Connect the shield with a large surface and fix it with metal cable binders or conductive clamp. The following is suitable for the connection of the shield:
  - The mounting plate
  - A central grounding rail
  - A shield sheet, optional where necessary
- This is optimal:
  - The motor cable is separated from the mains cables and control cables.
  - The motor cable only crosses mains cables and control cables at right angles.
  - The motor cable is not interrupted.
- If the motor cable must be opened all the same (e. g. by chokes, contactors, or terminals):
  - The unshielded cable ends must not be longer than 100 mm (depending on the cable cross-section).
  - Install chokes, contactors, terminals etc. spatially separated from other components (with a minimum distance of 100 mm).
  - Install the shield of the motor cable directly before and behind the point of separation to the mounting plate with a large surface.
- Connect the shield with a large surface to PE in the terminal box of the motor at the motor housing.
  - Metal EMC cable glands at the motor terminal box ensure a large surface connection of the shield with the motor housing.

## Control cables

- Install the cables so that no induction-sensitive loops arise.
- Distance of shield connections of control cables to shield connections of motor cables and DC cables:
  - At least 50 mm
- Control cables for analog signals:
  - Must always be shielded
  - Connect the shield on one side of the inverter
- Control cables for digital signals:

	Cable length		
	< ca. 5 m	ca. 5 m ... ca. 30 m	> ca. 30 m
Design	unshielded option	unshielded twisted option	always shielded connected on both sides

## Network cables

- Cables and wiring must comply with the specifications and requirements of the used network.
  - Ensures the reliable operation of the network in typical systems.



## Technical data

### Standards and operating conditions

#### Conformities/approvals

Conformity		
CE	2014/35/EU	Low-Voltage Directive
	2014/30/EU	EMC Directive (reference: CE-typical drive system)
EAC	TR TC 004/2011	Eurasian conformity: safety of low voltage equipment
	TP TC 020/2011	Eurasian conformity: electromagnetic compatibility of technical means
RoHS 2	2011/65/EU	Restrictions for the use of specific hazardous materials in electric and electronic devices
Approval		
UL	UL 61800-5-1	for USA and Canada (requirements of the CSA 22.2 No. 274)
		File No. E132659

#### Protection of persons and device protection

Enclosure		
IP20	EN 60529	
Type 1	NEMA 250	Protection against contact
Open type		only in UL-approved systems
Insulation resistance		
Overvoltage category III	EN 61800-5-1	0 ... 2000 m a.m.s.l.
Overvoltage category II		above 2000 m a.m.s.l.
Control circuit isolation		
Safe mains isolation by double/reinforced insulation	EN 61800-5-1	
Protective measures against		
Short circuit		Earth fault strength depends on the operating status
earth fault		
Overvoltage		
Motor stalling		
Leakage current		
> 3.5 mA AC, > 10 mA DC	EN 61800-5-1	Observe regulations and safety instructions!
Starting current		
≤ 3 x rated mains current		

#### EMC data

Actuation on public supply systems		
Implement measures to limit the radio interference to be expected:		The machine or plant manufacturer is responsible for compliance with the requirements for the machine/plant!
< 1 kW: with mains choke	EN 61000-3-2	
> 1 kW at mains current ≤ 16 A: without additional measures		
Mains current > 16 A: with mains choke or mains filter, with dimensioning for rated power. $R_{sce} \geq 120$ is to be met.	EN 61000-3-12	RSCE: short-circuit power ratio at the connection point of the machine/plant to the public network.
Noise emission		
Category C1	EN 61800-3	Type-dependent, for motor cable lengths see rated data
Category C2		
Noise immunity		
Meets requirement in compliance with	EN 61800-3	

# Technical data

Standards and operating conditions  
Electrical supply conditions



## Motor connection

Requirements to the shielded motor cable		
Capacitance per unit length		
C-core-core/C-core-shield < 75/150 pF/m		≤ 2.5 mm <sup>2</sup> / AWG 14
C-core-core/C-core-shield < 150/300 pF/m		≥ 4 mm <sup>2</sup> / AWG 12
Electric strength		
U <sub>o</sub> /U = 0.6/1.0 kV		U <sub>o</sub> = r.m.s. value external conductor to PE
U ≥ 600 V	UL	U = r.m.s. value external conductor/external conductor

## Environmental conditions

Energy efficiency		
Class IE2	EN 50598-2	Reference: Lenze setting (switching frequency 8 kHz variable)
Climate		
1K3 (-25 ... +60 °C)	EN 60721-3-1	Storage
2K3 (-25 ... +70 °C)	EN 60721-3-2	Transport
3K3 (-10 ... +55 °C)	EN 60721-3-3	operation
		Operation at a switching frequency of 2 or 4 kHz: above +45°C, reduce rated output current by 2.5 %/°C
		Operation at a switching frequency of 8 or 16 kHz: above +40°C, reduce rated output current by 2.5 %/°C
Site altitude		
0 ... 1000 m a.m.s.l.		
1000 ... 4000 m a.m.s.l.		Reduce rated output current by 5 %/1000 m
Pollution		
Degree of pollution 2	EN 61800-5-1	
Vibration resistance		
Transport		
2M2 (sine, shock)	EN 60721-3-2	
operation		
Amplitude 1 mm	Germanischer Lloyd	5 ... 13.2 Hz
Acceleration resistant up to 0.7 g		13.2 ... 100 Hz
Amplitude 0.075 mm	EN 61800-5-1	10 ... 57 Hz
Acceleration resistant up to 1 g		57 ... 150 Hz

## Electrical supply conditions

The connection to different supply forms enables a worldwide application of the inverters.

The following is supported:

- [1-phase mains connection 120 V](#) 47
- [1-phase mains connection 230/240 V](#) 51
- [3-phase mains connection 230/240 V](#) 62
- [3-phase mains connection 400 V](#) 69
- [3-phase mains connection 400 V "light duty"](#) 85
- [3-phase mains connection 480 V](#) 96
- [3-phase mains connection 480 V "Light Duty"](#) 111

Permissible mains systems		
TT		Voltage against earth: max. 300 V
TN		
IT		Apply the measures described for IT systems!
		IT systems are not relevant for UL-approved systems



## 1-phase mains connection 120 V



EMC filters are **not integrated** in inverters for this mains connection.

### Rated data

The output currents apply to these operating conditions:

- At a switching frequency of 2 kHz or 4 kHz: Max. ambient temperature 45°C.
- At a switching frequency of 8 kHz or 16 kHz: Max. ambient temperature 40 °C.

Inverter		i550-C0.25/120-1	i550-C0.37/120-1	i550-C0.75/120-1	i550-C1.1/120-1
<b>Rated power</b>	<b>kW</b>	<b>0.25</b>	<b>0.37</b>	<b>0.75</b>	<b>1.1</b>
Mains voltage range		1/N/PE AC 90 V ... 132 V, 45 Hz ... 65 Hz			
Output voltage		3 AC 0 V ... 240 V			
Rated mains current					
without mains choke	A	6.8	9.6	16.8	22.9
with mains choke	A	6	8.5	14.7	17.1
Apparent output power	kVA	0.6	0.9	1.6	2.2
Output current					
2 kHz	A	1.7	2.4	4.2	6
4 kHz	A	1.7	2.4	4.2	6
8 kHz	A	1.7	2.4	4.2	6
16 kHz	A	1.1	1.6	2.8	4
Power loss					
4 kHz	W	16	21	29	40
8 kHz	W	18	23	35	47
at controller inhibit	W	6	6	6	6
Overcurrent cycle 180 s					
Max. output current	A	2.6	3.6	6.3	9
Overload time	s	60	60	60	60
Recovery time	s	120	120	120	120
Max. output current during the recovery time	A	1.3	1.8	3.2	4.5
Overcurrent cycle 15 s					
Max. output current	A	3.4	4.8	8.4	12
Overload time	s	3	3	3	3
Recovery time	s	12	12	12	12
Max. output current during the recovery time	A	1.3	1.8	3.2	4.5
Cyclic mains switching		3 times per minute			
Brake chopper					
Max. output current	A	2.2	2.2	8.3	8.3
Min. brake resistance	Ω	180	180	47	47
Max. motor cable length shielded					
without EMC category	m	50			
Weight	kg	1		1.35	

# Technical data

1-phase mains connection 120 V  
Fusing and terminal data

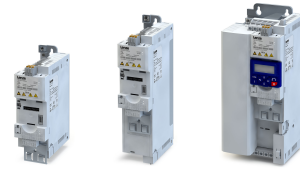

## Fusing and terminal data

Fuse data			
Inverter		i550-C0.25/120-1 i550-C0.37/120-1	i550-C0.75/120-1 i550-C1.1/120-1
Cable installation in compliance with		EN 60204-1	
Installation method		B2	
operation		without mains choke	
Fuse			
Characteristics		gG/gL or gRL	
Max. rated current	A	16	25
Circuit breaker			
Characteristics		B	
Max. rated current	A	16	25
operation		with mains choke	
Fuse			
Characteristics		gG/gL or gRL	
Max. rated current	A	16	25
Circuit breaker			
Characteristics		B	
Max. rated current	A	16	25
Earth-leakage circuit breaker			
1-phase mains connection		≥ 30 mA, type A or B	

Fuse data			
Inverter		i550-C0.25/120-1 i550-C0.37/120-1	i550-C0.75/120-1 i550-C1.1/120-1
Cable installation in compliance with		US National Electrical Code NFPA 70 / Canadian Electrical Code C22.1	
operation		without mains choke	
Fuse			
Characteristics		all acc. to UL 248 / Class CC	
Max. rated current	A	15	30
Circuit breaker			
Characteristics		-	
Max. rated current	A	15	30
operation		with mains choke	
Fuse			
Characteristics		all acc. to UL 248 / Class CC	
Max. rated current	A	15	30
Circuit breaker			
Characteristics		-	
Max. rated current	A	15	30
Earth-leakage circuit breaker			
1-phase mains connection		≥ 30 mA, type A or B	





# Technical data

1-phase mains connection 120 V  
Fusing and terminal data

<b>Mains connection</b>			
<b>Inverter</b>		<b>i550-C0.25/120-1 i550-C0.37/120-1</b>	<b>i550-C0.75/120-1 i550-C1.1/120-1</b>
Connection		X100	
Connection type		pluggable screw terminal	
Min. cable cross-section	mm <sup>2</sup>	1	
Max. cable cross-section	mm <sup>2</sup>	2.5	6
Stripping length	mm	8	
Tightening torque	Nm	0.5	0.7
Required tool		0.5 x 3.0	0.6 x 3.5

<b>PE</b>			
<b>Inverter</b>		<b>i550-C0.25/120-1 i550-C0.37/120-1 i550-C0.75/120-1 i550-C1.1/120-1</b>	
Connection		PE	
Connection type		PE screw	
Min. cable cross-section	mm <sup>2</sup>	1.5	
Max. cable cross-section	mm <sup>2</sup>	6	
Stripping length	mm	10	
Tightening torque	Nm	2	
Required tool		TORX TX20	

<b>Motor connection</b>			
<b>Inverter</b>		<b>i550-C0.25/120-1 i550-C0.37/120-1 i550-C0.75/120-1 i550-C1.1/120-1</b>	
Connection		X105	
Connection type		pluggable screw terminal	
Min. cable cross-section	mm <sup>2</sup>	1	
Max. cable cross-section	mm <sup>2</sup>	2.5	
Stripping length	mm	8	
Tightening torque	Nm	0.5	
Required tool		0.5 x 3.0	

# Technical data

1-phase mains connection 120 V  
Mains chokes

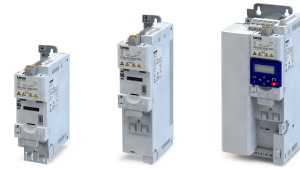

## Brake resistors

Inverter	Brake resistor					
	Order code	Rated resistance	Rated power	Thermal capacity	Dimensions (h x b x t)	Weight
		$\Omega$	W	kWs	mm	kg
i550-C0.25/120-1	ERBM180R050W	180	50	7.5	175 x 21 x 40	0.28
i550-C0.37/120-1						
i550-C0.75/120-1	ERBP047R200W	47	200	30	320 x 41 x 122	1
i550-C1.1/120-1						

## Mains chokes

Inverter	Mains choke					
	Order code	Number of phases	Output current	Inductance	Dimensions (h x b x t)	Weight
			A	mH	mm	kg
i550-C0.25/120-1	ELN1-0500H009	1	9	5	75 x 66 x 82	1.1
i550-C0.37/120-1						
i550-C0.75/120-1	ELN1-0250H018		18	2.5	96 x 96 x 90	2.1
i550-C1.1/120-1						

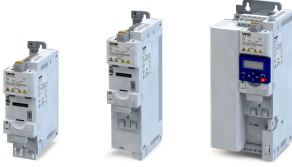

### 1-phase mains connection 230/240 V

Consider the following when selecting the inverters:

- **EMC filters** are **integrated** in the inverters i550-Cxxx/230-1.
- **EMC filters** are **not integrated** in the inverters i550-Cxxx/230-2.

# Technical data

1-phase mains connection 230/240 V  
Rated data



## Rated data

The output currents apply to these operating conditions:

- At a switching frequency of 2 kHz or 4 kHz: Max. ambient temperature 45°C.
- At a switching frequency of 8 kHz or 16 kHz: Max. ambient temperature 40 °C.

Inverter		i550-C0.25/230-1	i550-C0.25/230-2	i550-C0.37/230-1	i550-C0.37/230-2
<b>Rated power</b>	<b>kW</b>	<b>0.25</b>		<b>0.37</b>	
Mains voltage range		1/N/PE AC 170 V ... 264 V, 45 Hz ... 65 Hz			
Output voltage		3 AC 0 V ... 230 V/240 V			
Rated mains current					
without mains choke	A	4	4	5.7	5.7
with mains choke	A	3.6	3.6	4.8	4.8
Apparent output power	kVA	0.6		0.9	
Output current					
2 kHz	A	-	-	-	-
4 kHz	A	1.7	1.7	2.4	2.4
8 kHz	A	1.7	1.7	2.4	2.4
16 kHz	A	1.1	1.1	1.6	1.6
Power loss					
4 kHz	W	15	15	18	18
8 kHz	W	15	15	20	20
at controller inhibit	W	6	6	6	6
Overcurrent cycle 180 s					
Max. output current	A	2.6	2.6	3.6	3.6
Overload time	s	60	60	60	60
Recovery time	s	120	120	120	120
Max. output current during the recovery time	A	1.3	1.3	1.8	1.8
Overcurrent cycle 15 s					
Max. output current	A	3.4	3.4	4.8	4.8
Overload time	s	3	3	3	3
Recovery time	s	12	12	12	12
Max. output current during the recovery time	A	1.3	1.3	1.8	1.8
Cyclic mains switching		3 times per minute			
Brake chopper					
Max. output current	A	2.2	2.2	2.2	2.2
Min. brake resistance	Ω	180	180	180	180
Max. motor cable length shielded					
without EMC category	m	50			
Category C1 (2 kHz, 4 kHz, 8 kHz)	m	3	-	3	-
Category C2	m	15	-	15	-
Weight	kg	0.8			

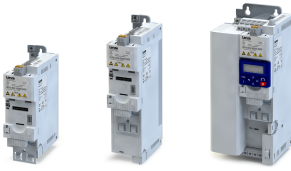

# Technical data

1-phase mains connection 230/240 V  
Rated data

Inverter		i550-C0.55/230-1	i550-C0.55/230-2	i550-C0.75/230-1	i550-C0.75/230-2
<b>Rated power</b>	<b>kW</b>	<b>0.55</b>		<b>0.75</b>	
Mains voltage range		1/N/PE AC 170 V ... 264 V, 45 Hz ... 65 Hz			
Output voltage		3 AC 0 V ... 230 V/240 V			
Rated mains current					
without mains choke	A	7.6	7.6	10	10
with mains choke	A	7.1	7.1	8.8	8.8
Apparent output power	kVA	1.2		1.6	
Output current					
2 kHz	A	3.2	3.2	4.2	4.2
4 kHz	A	3.2	3.2	4.2	4.2
8 kHz	A	3.2	3.2	4.2	4.2
16 kHz	A	2.1	2.1	2.8	2.8
Power loss					
4 kHz	W	23	23	29	29
8 kHz	W	25	25	33	33
at controller inhibit	W	6	6	6	6
Overcurrent cycle 180 s					
Max. output current	A	4.8	4.8	6.3	6.3
Overload time	s	60	60	60	60
Recovery time	s	120	120	120	120
Max. output current during the recovery time	A	2.4	2.4	3.2	3.2
Overcurrent cycle 15 s					
Max. output current	A	6.4	6.4	8.4	8.4
Overload time	s	3	3	3	3
Recovery time	s	12	12	12	12
Max. output current during the recovery time	A	2.4	2.4	3.2	3.2
Cyclic mains switching		3 times per minute			
Brake chopper					
Max. output current	A	3.9	3.9	3.9	3.9
Min. brake resistance	Ω	100	100	100	100
Max. motor cable length shielded					
without EMC category	m	50			
Category C1 (2 kHz, 4 kHz, 8 kHz)	m	3	-	3	-
Category C2	m	20	-	20	-
Weight	kg	1			

# Technical data

1-phase mains connection 230/240 V

Rated data



Inverter		i550-C1.1/230-1	i550-C1.1/230-2	i550-C1.5/230-1	i550-C1.5/230-2
<b>Rated power</b>	<b>kW</b>	<b>1.1</b>		<b>1.5</b>	
Mains voltage range		1/N/PE AC 170 V ... 264 V, 45 Hz ... 65 Hz			
Output voltage		3 AC 0 V ... 230 V/240 V			
Rated mains current					
without mains choke	A	14.3	14.3	16.7	16.7
with mains choke	A	11.9	11.9	13.9	13.9
Apparent output power	kVA	2.2		2.6	
Output current					
2 kHz	A	6	6	7	7
4 kHz	A	6	6	7	7
8 kHz	A	6	6	7	7
16 kHz	A	4	4	4.7	4.7
Power loss					
4 kHz	W	37	37	43	43
8 kHz	W	42	42	50	50
at controller inhibit	W	6	6	6	6
Overcurrent cycle 180 s					
Max. output current	A	9	9	10.5	10.5
Overload time	s	60	60	60	60
Recovery time	s	120	120	120	120
Max. output current during the recovery time	A	4.5	4.5	5.3	5.3
Overcurrent cycle 15 s					
Max. output current	A	12	12	14	14
Overload time	s	3	3	3	3
Recovery time	s	12	12	12	12
Max. output current during the recovery time	A	4.5	4.5	5.3	5.3
Cyclic mains switching		3 times per minute			
Brake chopper					
Max. output current	A	12	12	12	12
Min. brake resistance	Ω	33	33	33	33
Max. motor cable length shielded					
without EMC category	m	50			
Category C1 (2 kHz, 4 kHz, 8 kHz)	m	3	-	3	-
Category C2	m	20	-	20	-
Weight	kg	1.35			



# Technical data

1-phase mains connection 230/240 V  
Rated data

Inverter		i550-C2.2/230-1	i550-C2.2/230-2
<b>Rated power</b>	<b>kW</b>	<b>2.2</b>	
Mains voltage range		1/N/PE AC 170 V ... 264 V, 45 Hz ... 65 Hz	
Output voltage		3 AC 0 V ... 230 V/240 V	
Rated mains current			
without mains choke	A	22.5	22.5
with mains choke	A	16.9	16.9
Apparent output power	kVA	3.6	
Output current			
2 kHz	A	9.6	9.6
4 kHz	A	9.6	9.6
8 kHz	A	9.6	9.6
16 kHz	A	6.4	6.4
Power loss			
4 kHz	W	60	60
8 kHz	W	70	70
at controller inhibit	W	6	6
Overcurrent cycle 180 s			
Max. output current	A	14.4	14.4
Overload time	s	60	60
Recovery time	s	120	120
Max. output current during the recovery time	A	7.2	7.2
Overcurrent cycle 15 s			
Max. output current	A	19.2	19.2
Overload time	s	3	3
Recovery time	s	12	12
Max. output current during the recovery time	A	7.2	7.2
Cyclic mains switching		3 times per minute	
Brake chopper			
Max. output current	A	12	12
Min. brake resistance	Ω	33	33
Max. motor cable length shielded			
without EMC category	m	50	
Category C1 (2 kHz, 4 kHz, 8 kHz)	m	3	-
Category C2	m	20	-
Weight	kg	1.35	

# Technical data

1-phase mains connection 230/240 V  
Fusing and terminal data



## Fusing and terminal data

Fuse data					
Inverter		i550-C0.25/230-1 i550-C0.37/230-1	i550-C0.25/230-2 i550-C0.37/230-2	i550-C0.55/230-1 i550-C0.75/230-1	i550-C0.55/230-2 i550-C0.75/230-2
Cable installation in compliance with		EN 60204-1			
Installation method		B2			
operation		without mains choke			
Fuse		gG/gL or gRL			
Characteristics		gG/gL or gRL			
Max. rated current	A	10	10	16	16
Circuit breaker		B			
Characteristics		B			
Max. rated current	A	10	10	16	16
operation		with mains choke			
Fuse		gG/gL or gRL			
Characteristics		gG/gL or gRL			
Max. rated current	A	10	10	16	16
Circuit breaker		B			
Characteristics		B			
Max. rated current	A	10	10	16	16
Earth-leakage circuit breaker		≥ 30 mA, type A or B			
1-phase mains connection		≥ 30 mA, type A or B			
3-phase mains connection		-	≥ 30 mA, type B	-	≥ 30 mA, type B

Fuse data			
Inverter		i550-C1.1/230-1 i550-C1.5/230-1 i550-C2.2/230-1	i550-C1.1/230-2 i550-C1.5/230-2 i550-C2.2/230-2
Cable installation in compliance with		EN 60204-1	
Installation method		B2	
operation		without mains choke	
Fuse		gG/gL or gRL	
Characteristics		gG/gL or gRL	
Max. rated current	A	25	25
Circuit breaker		B	
Characteristics		B	
Max. rated current	A	25	25
operation		with mains choke	
Fuse		gG/gL or gRL	
Characteristics		gG/gL or gRL	
Max. rated current	A	25	25
Circuit breaker		B	
Characteristics		B	
Max. rated current	A	25	25
Earth-leakage circuit breaker		≥ 30 mA, type A or B	
1-phase mains connection		≥ 30 mA, type A or B	
3-phase mains connection		-	≥ 30 mA, type B





# Technical data

1-phase mains connection 230/240 V  
Fusing and terminal data

Fuse data					
Inverter		i550-C0.25/230-1 i550-C0.37/230-1 i550-C0.55/230-1 i550-C0.75/230-1	i550-C0.25/230-2 i550-C0.37/230-2 i550-C0.55/230-2 i550-C0.75/230-2	i550-C1.1/230-1 i550-C1.5/230-1 i550-C2.2/230-1	i550-C1.1/230-2 i550-C1.5/230-2 i550-C2.2/230-2
Cable installation in compliance with operation		US National Electrical Code NFPA 70 / Canadian Electrical Code C22.1 without mains choke			
Fuse		all acc. to UL 248 / Class CC			
Characteristics		all acc. to UL 248 / Class CC			
Max. rated current	A	15	15	30	30
Circuit breaker		-			
Characteristics		-			
Max. rated current	A	15	15	30	30
operation		with mains choke			
Fuse		all acc. to UL 248 / Class CC			
Characteristics		all acc. to UL 248 / Class CC			
Max. rated current	A	15	15	30	30
Circuit breaker		-			
Characteristics		-			
Max. rated current	A	15	15	30	30
Earth-leakage circuit breaker		≥ 30 mA, type A or B			
1-phase mains connection		≥ 30 mA, type A or B			
3-phase mains connection		-	≥ 30 mA, type B	-	≥ 30 mA, type B

# Technical data

1-phase mains connection 230/240 V  
Fusing and terminal data



Mains connection			
Inverter		i550-C0.25/230-1 i550-C0.25/230-2 i550-C0.37/230-1 i550-C0.37/230-2 i550-C0.55/230-1 i550-C0.55/230-2 i550-C0.75/230-1 i550-C0.75/230-2	i550-C1.1/230-1 i550-C1.1/230-2 i550-C1.5/230-1 i550-C1.5/230-2 i550-C2.2/230-1 i550-C2.2/230-2
Connection		X100	
Connection type		pluggable screw terminal	
Min. cable cross-section	mm <sup>2</sup>	1	
Max. cable cross-section	mm <sup>2</sup>	2.5	6
Stripping length	mm	8	
Tightening torque	Nm	0.5	0.7
Required tool		0.5 x 3.0	0.6 x 3.5

PE			
Inverter		i550-C0.25/230-1 i550-C0.25/230-2 i550-C0.37/230-1 i550-C0.37/230-2 i550-C0.55/230-1 i550-C0.55/230-2 i550-C0.75/230-1 i550-C0.75/230-2 i550-C1.1/230-1 i550-C1.1/230-2 i550-C1.5/230-1 i550-C1.5/230-2 i550-C2.2/230-1 i550-C2.2/230-2	
Connection		PE	
Connection type		PE screw	
Min. cable cross-section	mm <sup>2</sup>	1.5	
Max. cable cross-section	mm <sup>2</sup>	6	
Stripping length	mm	10	
Tightening torque	Nm	2	
Required tool		TORX TX20	

Motor connection			
Inverter		i550-C0.25/230-1 i550-C0.25/230-2 i550-C0.37/230-1 i550-C0.37/230-2 i550-C0.55/230-1 i550-C0.55/230-2 i550-C0.75/230-1 i550-C0.75/230-2 i550-C1.1/230-1 i550-C1.1/230-2 i550-C1.5/230-1 i550-C1.5/230-2 i550-C2.2/230-1 i550-C2.2/230-2	
Connection		X105	
Connection type		pluggable screw terminal	
Min. cable cross-section	mm <sup>2</sup>	1	
Max. cable cross-section	mm <sup>2</sup>	2.5	
Stripping length	mm	8	
Tightening torque	Nm	0.5	
Required tool		0.5 x 3.0	



# Technical data

1-phase mains connection 230/240 V  
Mains chokes

## Brake resistors

Inverter	Brake resistor					
	Order code	Rated resistance	Rated power	Thermal capacity	Dimensions (h x b x t)	Weight
		Ω	W	kWs	mm	kg
i550-C0.25/230-1	ERBM180R050W	180	50	7.5	175 x 21 x 40	0.28
i550-C0.25/230-2						
i550-C0.37/230-1						
i550-C0.37/230-2						
i550-C0.55/230-1	ERBM100R100W	100	100	15	240 x 80 x 95	0.37
i550-C0.55/230-2						
i550-C0.75/230-1						
i550-C0.75/230-2						
i550-C1.1/230-1	ERBP033R200W	33	200	30	240 x 41 x 122	1
	ERBP033R300W		300	45	320 x 41 x 122	1.4
i550-C1.1/230-2	ERBP033R200W		200	30	240 x 41 x 122	1
	ERBP033R300W		300	45	320 x 41 x 122	1.4
i550-C1.5/230-1	ERBP033R200W		200	30	240 x 41 x 122	1
	ERBP033R300W		300	45	320 x 41 x 122	1.4
i550-C1.5/230-2	ERBP033R200W		200	30	240 x 41 x 122	1
	ERBP033R300W		300	45	320 x 41 x 122	1.4
i550-C2.2/230-1	ERBP033R200W		200	30	240 x 41 x 122	1
	ERBP033R300W		300	45	320 x 41 x 122	1.4
i550-C2.2/230-2	ERBP033R200W		200	30	240 x 41 x 122	1
	ERBP033R300W		300	45	320 x 41 x 122	1.4

## Mains chokes

Inverter	Mains choke					
	Order code	Number of phases	Output current	Inductance	Dimensions (h x b x t)	Weight
			A	mH	mm	kg
i550-C0.25/230-1	ELN1-0900H005	1	5	9	75 x 66 x 82	1.1
i550-C0.25/230-2						
i550-C0.37/230-1						
i550-C0.37/230-2						
i550-C0.55/230-1	ELN1-0500H009		9	5	75 x 66 x 82	1.1
i550-C0.55/230-2						
i550-C0.75/230-1						
i550-C0.75/230-2						
i550-C1.1/230-1	ELN1-0250H018	18	2.5	96 x 96 x 90	2.1	
i550-C1.1/230-2						
i550-C1.5/230-1						
i550-C1.5/230-2						
i550-C2.2/230-1						
i550-C2.2/230-2						

# Technical data

1-phase mains connection 230/240 V  
RFI filters / Mains filters



## RFI filters / Mains filters

Basic information on RFI filters, mains filters and EMC: from [163](#)

### Maximum motor cable lengths and FI operation

Mains connection			1-phase, 230 V		
Inverter			i550-C0.25/230-1 i550-C0.37/230-1	i550-C0.55/230-1 i550-C0.75/230-1	i550-C1.1/230-1 i550-C1.5/230-1 i550-C2.2/230-1
Without RFI filter					
without EMC category	Max. motor cable length shielded	m	50	50	50
Thermal limitation	Max. motor cable length unshielded	m	100	100	200
With integrated RFI filter					
Category C1	Max. motor cable length shielded	m	3	3	3
Category C2		m	15	20	20
	Earth-leakage circuit breaker	mA	30	30	30
RFI filter Low Leakage					
Category C1	Max. motor cable length shielded	m	5	5	5
	Earth-leakage circuit breaker	mA	10	10	10
RFI filter Short Distance					
Category C1	Max. motor cable length shielded	m	25	25	25
Category C2		m	50	50	50
	Earth-leakage circuit breaker	mA	30	30	30
RFI filter Long Distance					
Category C1	Max. motor cable length shielded	m	50	50	50
Category C2		m	50	50	50
	Earth-leakage circuit breaker	mA	300	300	300



# Technical data

1-phase mains connection 230/240 V  
RFI filters / Mains filters

## Low Leakage

Inverter	RFI filter			
	Order code	Output current	Dimensions (h x b x t)	Weight
		A	mm	kg
i550-C0.25/230-1	IOFAE175B100L0000S	9	276 x 60 x 50	1
i550-C0.37/230-1				
i550-C0.55/230-1				
i550-C0.75/230-1				
i550-C1.1/230-1	IOFAE222B100L0000S	21.8	346 x 60 x 50	1.4
i550-C1.5/230-1				
i550-C2.2/230-1				

## Short Distance

Inverter	RFI filter			
	Order code	Output current	Dimensions (h x b x t)	Weight
		A	mm	kg
i550-C0.25/230-1	IOFAE175B100S0000S	9	276 x 60 x 50	0.85
i550-C0.37/230-1				
i550-C0.55/230-1				
i550-C0.75/230-1				
i550-C1.1/230-1	IOFAE222B100S0000S	21.8	346 x 60 x 50	1.2
i550-C1.5/230-1				
i550-C2.2/230-1				

## Long Distance

Inverter	RFI filter			
	Order code	Output current	Dimensions (h x b x t)	Weight
		A	mm	kg
i550-C0.25/230-1	IOFAE175B100D0000S	9	276 x 60 x 50	0.85
i550-C0.37/230-1				
i550-C0.55/230-1				
i550-C0.75/230-1				
i550-C1.1/230-1	IOFAE222B100D0000S	21.8	346 x 60 x 50	1.2
i550-C1.5/230-1				
i550-C2.2/230-1				

## Technical data

3-phase mains connection 230/240 V



---

### 3-phase mains connection 230/240 V



**EMC filters are not integrated** in inverters for this mains connection.

---



**Rated data**

The output currents apply to these operating conditions:

- At a switching frequency of 2 kHz or 4 kHz: Max. ambient temperature 45°C.
- At a switching frequency of 8 kHz or 16 kHz: Max. ambient temperature 40 °C.

Inverter		i550-C0.25/230-2	i550-C0.37/230-2	i550-C0.55/230-2	i550-C0.75/230-2
<b>Rated power</b>	<b>kW</b>	<b>0.25</b>	<b>0.37</b>	<b>0.55</b>	<b>0.75</b>
Mains voltage range		3/PE AC 170 V ... 264 V, 45 Hz ... 65 Hz			
Output voltage		3 AC 0 V ... 230 V/240 V			
Rated mains current					
without mains choke	A	2.6	3.9	4.8	6.4
with mains choke	A	2	3	3.8	5.1
Apparent output power	kVA	0.6	0.9	1.2	1.6
Output current					
2 kHz	A	-	-	3.2	4.2
4 kHz	A	1.7	2.4	3.2	4.2
8 kHz	A	1.7	2.4	3.2	4.2
16 kHz	A	1.1	1.6	2.1	2.8
Power loss					
4 kHz	W	15	18	23	29
8 kHz	W	15	20	25	33
at controller inhibit	W	6	6	6	6
Overcurrent cycle 180 s					
Max. output current	A	2.6	3.6	4.8	6.3
Overload time	s	60	60	60	60
Recovery time	s	120	120	120	120
Max. output current during the recovery time	A	1.3	1.8	2.4	3.2
Overcurrent cycle 15 s					
Max. output current	A	3.4	4.8	6.4	8.4
Overload time	s	3	3	3	3
Recovery time	s	12	12	12	12
Max. output current during the recovery time	A	1.3	1.8	2.4	3.2
Cyclic mains switching		3 times per minute			
Brake chopper					
Max. output current	A	2.2	2.2	3.9	3.9
Min. brake resistance	Ω	180	180	100	100
Max. motor cable length shielded					
without EMC category	m	50			
Weight	kg	0.8		1	

# Technical data

3-phase mains connection 230/240 V

Rated data



Inverter		i550-C1.1/230-2	i550-C1.5/230-2	i550-C2.2/230-2	i550-C4.0/230-3
<b>Rated power</b>	<b>kW</b>	<b>1.1</b>	<b>1.5</b>	<b>2.2</b>	<b>4</b>
Mains voltage range		3/PE AC 170 V ... 264 V, 45 Hz ... 65 Hz			
Output voltage		3 AC 0 V ... 230 V/240 V			
Rated mains current					
without mains choke	A	7.8	9.5	13.6	20.6
with mains choke	A	5.6	6.8	9.8	15.7
Apparent output power	kVA	2.2	2.6	3.6	6.4
Output current					
2 kHz	A	6	7	9.6	16.5
4 kHz	A	6	7	9.6	16.5
8 kHz	A	6	7	9.6	16.5
16 kHz	A	4	4.7	6.4	11
Power loss					
4 kHz	W	37	43	60	115
8 kHz	W	42	50	70	130
at controller inhibit	W	6	6	6	6
Overcurrent cycle 180 s					
Max. output current	A	9	10.5	14.4	24.8
Overload time	s	60	60	60	60
Recovery time	s	120	120	120	120
Max. output current during the recovery time	A	4.5	5.3	7.2	12.4
Overcurrent cycle 15 s					
Max. output current	A	12	14	19.2	33
Overload time	s	3	3	3	3
Recovery time	s	12	12	12	12
Max. output current during the recovery time	A	4.5	5.3	7.2	12.4
Cyclic mains switching		3 times per minute			
Brake chopper					
Max. output current	A	12	12	12	26
Min. brake resistance	Ω	33	33	33	15
Max. motor cable length shielded					
without EMC category	m	50			
Weight	kg	1.35			2.1





# Technical data

3-phase mains connection 230/240 V  
Rated data

Inverter		i550-C5.5/230-3	
<b>Rated power</b>	<b>kW</b>	<b>5.5</b>	
Mains voltage range		3/PE AC 170 V ... 264 V, 45 Hz ... 65 Hz	
Output voltage		3 AC 0 V ... 230 V/240 V	
Rated mains current			
without mains choke	A	28.8	
with mains choke	A	21.9	
Apparent output power	kVA	8.7	
Output current			
2 kHz	A	23	
4 kHz	A	23	
8 kHz	A	23	
16 kHz	A	15.3	
Power loss			
4 kHz	W	175	
8 kHz	W	195	
at controller inhibit	W	6	
Overcurrent cycle 180 s			
Max. output current	A	34.5	
Overload time	s	60	
Recovery time	s	120	
Max. output current during the recovery time	A	17.3	
Overcurrent cycle 15 s			
Max. output current	A	46	
Overload time	s	3	
Recovery time	s	12	
Max. output current during the recovery time	A	17.3	
Cyclic mains switching		3 times per minute	
Brake chopper			
Max. output current	A	26	
Min. brake resistance	Ω	15	
Max. motor cable length shielded			
without EMC category	m	50	
Weight	kg	2.1	

# Technical data

3-phase mains connection 230/240 V  
Fusing and terminal data



## Fusing and terminal data

Fuse data					
Inverter		i550-C0.25/230-2 i550-C0.37/230-2	i550-C0.55/230-2 i550-C0.75/230-2	i550-C1.1/230-2 i550-C1.5/230-2 i550-C2.2/230-2	i550-C4.0/230-3 i550-C5.5/230-3
Cable installation in compliance with		EN 60204-1			
Installation method		B2			C
operation		without mains choke			
Fuse		gG/gL or gRL			
Characteristics		gG/gL or gRL			
Max. rated current	A	10	16	25	32
Circuit breaker		B			
Characteristics		B			
Max. rated current	A	10	16	25	32
operation		with mains choke			
Fuse		gG/gL or gRL			
Characteristics		gG/gL or gRL			
Max. rated current	A	10	16	25	32
Circuit breaker		B			
Characteristics		B			
Max. rated current	A	10	16	25	32
Earth-leakage circuit breaker					
1-phase mains connection		≥ 30 mA, type A or B			-
3-phase mains connection		≥ 30 mA, type B			≥ 300 mA, type B

Fuse data					
Inverter		i550-C0.25/230-2 i550-C0.37/230-2 i550-C0.55/230-2 i550-C0.75/230-2	i550-C1.1/230-2 i550-C1.5/230-2 i550-C2.2/230-2	i550-C4.0/230-3 i550-C5.5/230-3	
Cable installation in compliance with		US National Electrical Code NFPA 70 / Canadian Electrical Code C22.1			
operation		without mains choke			
Fuse		all acc. to UL 248 / Class CC			
Characteristics		all acc. to UL 248 / Class CC			all acc. to UL 248 / Class J, T, R
Max. rated current	A	15	30	40	
Circuit breaker		-			
Characteristics		-			
Max. rated current	A	15	30	-	
operation		with mains choke			
Fuse		all acc. to UL 248 / Class CC			
Characteristics		all acc. to UL 248 / Class CC			all acc. to UL 248 / Class J, T, R
Max. rated current	A	15	30	40	
Circuit breaker		-			
Characteristics		-			
Max. rated current	A	15	30	-	
Earth-leakage circuit breaker					
1-phase mains connection		≥ 30 mA, type A or B			-
3-phase mains connection		≥ 30 mA, type B			≥ 300 mA, type B

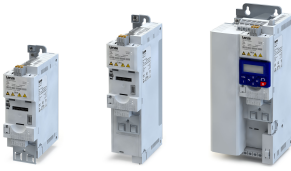

# Technical data

3-phase mains connection 230/240 V  
Fusing and terminal data

Mains connection				
<b>Inverter</b>		i550-C0.25/230-2 i550-C0.37/230-2 i550-C0.55/230-2 i550-C0.75/230-2	i550-C1.1/230-2 i550-C1.5/230-2 i550-C2.2/230-2	i550-C4.0/230-3 i550-C5.5/230-3
Connection		X100		
Connection type		pluggable screw terminal		Screw terminal
Min. cable cross-section	mm <sup>2</sup>	1		1.5
Max. cable cross-section	mm <sup>2</sup>	2.5	6	
Stripping length	mm	8		9
Tightening torque	Nm	0.5	0.7	0.5
Required tool		0.5 x 3.0	0.6 x 3.5	

PE				
<b>Inverter</b>		i550-C0.25/230-2 i550-C0.37/230-2 i550-C0.55/230-2 i550-C0.75/230-2 i550-C1.1/230-2 i550-C1.5/230-2 i550-C2.2/230-2 i550-C4.0/230-3 i550-C5.5/230-3		
Connection		PE		
Connection type		PE screw		
Min. cable cross-section	mm <sup>2</sup>	1.5		
Max. cable cross-section	mm <sup>2</sup>	6		
Stripping length	mm	10		
Tightening torque	Nm	2		
Required tool		TORX TX20		

Motor connection				
<b>Inverter</b>		i550-C0.25/230-2 i550-C0.37/230-2 i550-C0.55/230-2 i550-C0.75/230-2 i550-C1.1/230-2 i550-C1.5/230-2 i550-C2.2/230-2	i550-C4.0/230-3 i550-C5.5/230-3	
Connection		X105		
Connection type		pluggable screw terminal		Screw terminal
Min. cable cross-section	mm <sup>2</sup>	1		1.5
Max. cable cross-section	mm <sup>2</sup>	2.5		6
Stripping length	mm	8		9
Tightening torque	Nm	0.5		
Required tool		0.5 x 3.0		0.6 x 3.5

# Technical data

3-phase mains connection 230/240 V  
Mains chokes



## Brake resistors

Inverter	Brake resistor						
	Order code	Rated resistance	Rated power	Thermal capacity	Dimensions (h x b x t)	Weight	
		Ω	W	kWs	mm	kg	
i550-C0.25/230-2	ERBM180R050W	180	50	7.5	175 x 21 x 40	0.28	
i550-C0.37/230-2							
i550-C0.55/230-2	ERBM100R100W	100	100	15	240 x 80 x 95	0.37	
i550-C0.75/230-2							
i550-C1.1/230-2	ERBP033R200W	33	200	30	240 x 41 x 122	1	
	ERBP033R300W		300	45	320 x 41 x 122	1.4	
i550-C1.5/230-2	ERBP033R200W		200	30	240 x 41 x 122	1	
	ERBP033R300W		300	45	320 x 41 x 122	1.4	
i550-C2.2/230-2	ERBP033R200W		200	30	240 x 41 x 122	1	
	ERBP033R300W		300	45	320 x 41 x 122	1.4	
i550-C4.0/230-3	ERBP027R200W		27	200	30	320 x 41 x 122	1
	ERBS027R600W			600	90		550 x 110 x 105
	ERBS015R800W		15	800	120	710 x 110 x 105	3.9
	ERBS015R01K2			1200	180	1020 x 110 x 105	5.6
i550-C5.5/230-3	ERBP027R200W		27	200	30	320 x 41 x 122	1
	ERBS027R600W			600	90	550 x 110 x 105	3.1
	ERBS015R800W	15	800	120	710 x 110 x 105	3.9	
	ERBS015R01K2		1200	180	1020 x 110 x 105	5.6	

## Mains chokes

Inverter	Mains choke					
	Order code	Number of phases	Output current	Inductance	Dimensions (h x b x t)	Weight
			A	mH	mm	kg
i550-C0.25/230-2	EZAELN3002B153	3	2	14.7	56 x 77 x 100	0.53
i550-C0.37/230-2	EZAELN3004B742		4	7.35	60 x 95 x 115	1.31
i550-C0.55/230-2						
i550-C0.75/230-2	EZAELN3006B492		6	4.9	69 x 95 x 120	1.45
i550-C1.1/230-2	EZAELN3008B372		8	3.68	85 x 120 x 140	1.9
i550-C1.5/230-2						
i550-C2.2/230-2						
i550-C4.0/230-3	EZAELN3016B182		16	1.84	95 x 120 x 140	2.7
i550-C5.5/230-3	EZAELN3025B122		25	1.18	110 x 155 x 170	5.8



### 3-phase mains connection 400 V

#### Rated data

The output currents apply to these operating conditions:

- At a switching frequency of 2 kHz or 4 kHz: Max. ambient temperature 45°C.
- At a switching frequency of 8 kHz or 16 kHz: Max. ambient temperature 40 °C.

Inverter		i550-C0.37/400-3	i550-C0.55/400-3	i550-C0.75/400-3	i550-C1.1/400-3
<b>Rated power</b>	<b>kW</b>	<b>0.37</b>	<b>0.55</b>	<b>0.75</b>	<b>1.1</b>
Mains voltage range		3/PE AC 340 V ... 528 V, 45 Hz ... 65 Hz			
Output voltage		3 AC 0 V ... 400 V			
Rated mains current					
without mains choke	A	1.8	2.5	3.3	4.4
with mains choke	A	1.4	2	2.6	3
Apparent output power	kVA	0.9	1.2	1.6	2.2
Output current					
2 kHz	A	-	1.8	2.4	3.2
4 kHz	A	1.3	1.8	2.4	3.2
8 kHz	A	1.3	1.8	2.4	3.2
16 kHz	A	0.9	1.2	1.6	2.1
Power loss					
4 kHz	W	20	25	32	40
8 kHz	W	24	31	40	51
at controller inhibit	W	6	6	6	6
Overcurrent cycle 180 s					
Max. output current	A	2	2.7	3.6	4.8
Overload time	s	60	60	60	60
Recovery time	s	120	120	120	120
Max. output current during the recovery time	A	1	1.4	1.8	2.4
Overcurrent cycle 15 s					
Max. output current	A	2.6	3.6	4.8	6.4
Overload time	s	3	3	3	3
Recovery time	s	12	12	12	12
Max. output current during the recovery time	A	1	1.4	1.8	2.4
Cyclic mains switching		3 times per minute			
Brake chopper					
Max. output current	A	2	2	2	4.3
Min. brake resistance	Ω	390	390	390	180
Max. motor cable length shielded					
without EMC category	m	15	50		
Category C1 (2 kHz, 4 kHz, 8 kHz)	m	3			-
Category C2	m	15	20		
Weight	kg	0.8	1		1.35

# Technical data

3-phase mains connection 400 V

Rated data



Inverter		i550-C1.5/400-3	i550-C2.2/400-3	i550-C3.0/400-3	i550-C4.0/400-3
<b>Rated power</b>	<b>kW</b>	<b>1.5</b>	<b>2.2</b>	<b>3</b>	<b>4</b>
Mains voltage range		3/PE AC 340 V ... 528 V, 45 Hz ... 65 Hz			
Output voltage		3 AC 0 V ... 400 V			
Rated mains current					
without mains choke	A	5.4	7.8	9.6	12.5
with mains choke	A	3.7	5.3	6.9	9
Apparent output power	kVA	2.6	3.8	4.9	6.4
Output current					
2 kHz	A	3.9	5.6	7.3	9.5
4 kHz	A	3.9	5.6	7.3	9.5
8 kHz	A	3.9	5.6	7.3	9.5
16 kHz	A	2.6	3.7	4.9	6.3
Power loss					
4 kHz	W	48	66	85	110
8 kHz	W	61	85	110	140
at controller inhibit	W	6	6	6	6
Overcurrent cycle 180 s					
Max. output current	A	5.9	8.4	11	14.3
Overload time	s	60	60	60	60
Recovery time	s	120	120	120	120
Max. output current during the recovery time	A	2.9	4.2	5.5	7.1
Overcurrent cycle 15 s					
Max. output current	A	7.8	11.2	14.6	19
Overload time	s	3	3	3	3
Recovery time	s	12	12	12	12
Max. output current during the recovery time	A	2.9	4.2	5.5	7.1
Cyclic mains switching		3 times per minute			
Brake chopper					
Max. output current	A	4.3	4.3	9.5	16.6
Min. brake resistance	Ω	180	150	82	47
Max. motor cable length shielded					
without EMC category	m	50			
Category C1 (2 kHz, 4 kHz, 8 kHz)	m	-			
Category C2	m	20			
Weight	kg	1.35		2.3	

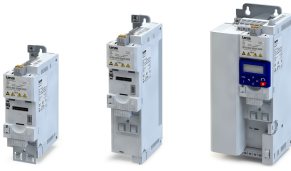

# Technical data

3-phase mains connection 400 V  
Rated data

Inverter		i550-C5.5/400-3	i550-C7.5/400-3	i550-C11/400-3	i550-C15/400-3
<b>Rated power</b>	<b>kW</b>	<b>5.5</b>	<b>7.5</b>	<b>11</b>	<b>15</b>
Mains voltage range		3/PE AC 340 V ... 528 V, 45 Hz ... 65 Hz			
Output voltage		3 AC 0 V ... 400 V			
Rated mains current					
without mains choke	A	17.2	20	28.4	38.7
with mains choke	A	12.4	15.7	22.3	28.8
Apparent output power	kVA	8.7	11	16	22
Output current					
2 kHz	A	13	16.5	23.5	32
4 kHz	A	13	16.5	23.5	32
8 kHz	A	13	16.5	23.5	32
16 kHz	A	8.7	11	15.7	21.3
Power loss					
4 kHz	W	145	185	260	360
8 kHz	W	190	240	340	460
at controller inhibit	W	6	6	6	18
Overcurrent cycle 180 s					
Max. output current	A	19.5	25	35	48
Overload time	s	60	60	60	60
Recovery time	s	120	120	120	120
Max. output current during the recovery time	A	9.8	12.4	17.6	24
Overcurrent cycle 15 s					
Max. output current	A	26	33	47	64
Overload time	s	3	3	3	3
Recovery time	s	12	12	12	12
Max. output current during the recovery time	A	9.8	12.4	17.6	24
Cyclic mains switching		3 times per minute			
Brake chopper					
Max. output current	A	16.6	29	29	43
Min. brake resistance	Ω	47	27	27	18
Max. motor cable length shielded					
without EMC category	m	50	100		
Category C1 (2 kHz, 4 kHz, 8 kHz)	m	-			
Category C2	m	20			
Weight	kg	2.3	3.7		10.3

# Technical data

3-phase mains connection 400 V

Rated data

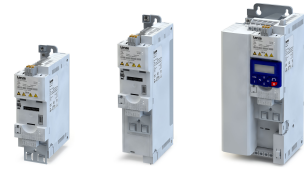

Inverter		i550-C18/400-3	i550-C22/400-3	i550-C30/400-3	i550-C37/400-3
<b>Rated power</b>	<b>kW</b>	<b>18.5</b>	<b>22</b>	<b>30</b>	<b>37</b>
Mains voltage range		3/PE AC 340 V ... 528 V, 45 Hz ... 65 Hz			
Output voltage		3 AC 0 V ... 400 V			
Rated mains current					
without mains choke	A	48.4	-	-	-
with mains choke	A	36	42	54.9	68
Apparent output power	kVA	27	32	41	51
Output current					
2 kHz	A	40	47	61	76
4 kHz	A	40	47	61	76
8 kHz	A	40	47	61	76
16 kHz	A	26.6	31.3	40.7	50.7
Power loss					
4 kHz	W	450	520	680	840
8 kHz	W	570	670	880	1100
at controller inhibit	W	18	18	25	25
Overcurrent cycle 180 s					
Max. output current	A	60	71	92	114
Overload time	s	60	60	60	60
Recovery time	s	120	120	120	120
Max. output current during the recovery time	A	30	35	46	57
Overcurrent cycle 15 s					
Max. output current	A	80	94	122	152
Overload time	s	3	3	3	3
Recovery time	s	12	12	12	12
Max. output current during the recovery time	A	30	35	46	57
Cyclic mains switching		3 times per minute			
Brake chopper					
Max. output current	A	52	52	98	98
Min. brake resistance	Ω	15	15	7.5	7.5
Max. motor cable length shielded					
without EMC category	m	100			
Category C1 (2 kHz, 4 kHz, 8 kHz)	m	-			
Category C2	m	20			
Weight	kg	10.3		17.2	



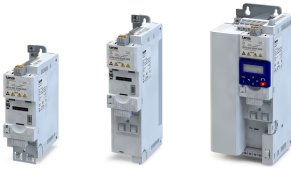

# Technical data

3-phase mains connection 400 V  
Rated data

Inverter		i550-C45/400-3	i550-C55/400-3	i550-C75/400-3
<b>Rated power</b>	<b>kW</b>	<b>45</b>	<b>55</b>	<b>75</b>
Mains voltage range		3/PE AC 340 V ... 528 V, 45 Hz ... 65 Hz		
Output voltage		3 AC 0 V ... 400 V		
Rated mains current				
without mains choke	A	-	-	-
with mains choke	A	80	99	135
Apparent output power	kVA	60	75	100
Output current				
2 kHz	A	89	110	150
4 kHz	A	89	110	150
8 kHz	A	89	110	150
16 kHz	A	59.4	73.4	100
Power loss				
4 kHz	W	980	1210	1640
8 kHz	W	1280	1580	2140
at controller inhibit	W	25	30	30
Overcurrent cycle 180 s				
Max. output current	A	134	165	225
Overload time	s	60	60	60
Recovery time	s	120	120	120
Max. output current during the recovery time	A	67	83	113
Overcurrent cycle 15 s				
Max. output current	A	178	220	300
Overload time	s	3	3	3
Recovery time	s	12	12	12
Max. output current during the recovery time	A	67	83	113
Cyclic mains switching		3 times per minute	1 time per minute	
Brake chopper				
Max. output current	A	98	166	166
Min. brake resistance	Ω	7.5	4.7	4.7
Max. motor cable length shielded				
without EMC category	m	100		
Category C1 (2 kHz, 4 kHz, 8 kHz)	m	-		
Category C2	m	20		
Weight	kg	17.2	24	

# Technical data

3-phase mains connection 400 V  
Fusing and terminal data

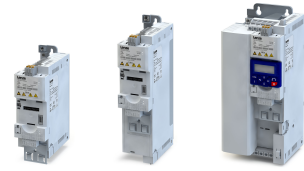

## Fusing and terminal data

Fuse data					
Inverter		i550-C0.37/400-3 i550-C0.55/400-3 i550-C0.75/400-3	i550-C1.1/400-3 i550-C1.5/400-3 i550-C2.2/400-3	i550-C3.0/400-3 i550-C4.0/400-3 i550-C5.5/400-3	i550-C7.5/400-3 i550-C11/400-3
Cable installation in compliance with		EN 60204-1			
Installation method		B2			
operation		without mains choke			
Fuse		gG/gL or gRL			
Characteristics		gG/gL or gRL			
Max. rated current	A	10	16	25	32
Circuit breaker		B			
Characteristics		B			
Max. rated current	A	10	16	25	32
operation		with mains choke			
Fuse		gG/gL or gRL			
Characteristics		gG/gL or gRL			
Max. rated current	A	10	16	25	32
Circuit breaker		B			
Characteristics		B			
Max. rated current	A	10	16	25	32
Earth-leakage circuit breaker					
3-phase mains connection		≥ 30 mA, type B		≥ 300 mA, type B	

Fuse data					
Inverter		i550-C15/400-3 i550-C18/400-3	i550-C22/400-3	i550-C30/400-3	i550-C37/400-3
Cable installation in compliance with		EN 60204-1			
Installation method		B2		C	
operation		without mains choke			
Fuse		gG/gL or gRL		-	
Characteristics		gG/gL or gRL		-	
Max. rated current	A	63	-	-	-
Circuit breaker		B		-	
Characteristics		B		-	
Max. rated current	A	63	-	-	-
operation		with mains choke			
Fuse		gG/gL or gRL			
Characteristics		gG/gL or gRL			
Max. rated current	A	63	63	80	100
Circuit breaker		B			
Characteristics		B			
Max. rated current	A	63	63	80	100
Earth-leakage circuit breaker					
3-phase mains connection		≥ 300 mA, type B			



# Technical data

3-phase mains connection 400 V  
Fusing and terminal data

Fuse data			
Inverter		i550-C45/400-3	i550-C55/400-3 i550-C75/400-3
Cable installation in compliance with		EN 60204-1	
Installation method		C	F
operation			
Fuse			
Characteristics		-	
Max. rated current	A	-	-
Circuit breaker			
Characteristics		-	
Max. rated current	A	-	-
operation		with mains choke	
Fuse			
Characteristics		gG/gL or gRL	gR
Max. rated current	A	125	160
Circuit breaker			
Characteristics		B	-
Max. rated current	A	125	-
Earth-leakage circuit breaker			
3-phase mains connection		≥ 300 mA, type B	

Fuse data					
Inverter		i550-C0.37/400-3 i550-C0.55/400-3 i550-C0.75/400-3 i550-C1.1/400-3 i550-C1.5/400-3 i550-C2.2/400-3	i550-C3.0/400-3 i550-C4.0/400-3 i550-C5.5/400-3	i550-C7.5/400-3	i550-C11/400-3
Cable installation in compliance with		US National Electrical Code NFPA 70 / Canadian Electrical Code C22.1			
operation		without mains choke			
Fuse					
Characteristics		all acc. to UL 248 / Class CC		all acc. to UL 248 / Class J, T, R	
Max. rated current	A	15	25	40	40
Circuit breaker					
Characteristics		-			
Max. rated current	A	-	25	35	-
operation		with mains choke			
Fuse					
Characteristics		all acc. to UL 248 / Class CC		all acc. to UL 248 / Class J, T, R	
Max. rated current	A	15	25	40	40
Circuit breaker					
Characteristics		-			
Max. rated current	A	-	25	35	-
Earth-leakage circuit breaker					
3-phase mains connection		≥ 30 mA, type B	≥ 300 mA, type B		

# Technical data

3-phase mains connection 400 V  
Fusing and terminal data



Fuse data					
Inverter		i550-C15/400-3 i550-C18/400-3	i550-C22/400-3	i550-C30/400-3	i550-C37/400-3
Cable installation in compliance with operation		US National Electrical Code NFPA 70 / Canadian Electrical Code C22.1			
Fuse		without mains choke			
Characteristics		all acc. to UL 248 / Class J, T, R		-	
Max. rated current	A	70	-	-	-
Circuit breaker					
Characteristics		-	-	-	-
Max. rated current	A	-	-	-	-
operation		with mains choke			
Fuse		all acc. to UL 248 / Class J, T, R			
Max. rated current	A	70	70	80	100
Circuit breaker					
Characteristics		-	-	-	-
Max. rated current	A	-	-	-	-
Earth-leakage circuit breaker					
3-phase mains connection		≥ 300 mA, type B			

Fuse data			
Inverter		i550-C45/400-3	i550-C55/400-3 i550-C75/400-3
Cable installation in compliance with operation		US National Electrical Code NFPA 70 / Canadian Electrical Code C22.1	
Fuse			
Characteristics		-	
Max. rated current	A	-	-
Circuit breaker			
Characteristics		-	-
Max. rated current	A	-	-
operation		with mains choke	
Fuse			
Characteristics		all acc. to UL 248 / Class J, T, R	acc. to UL 248 / Class J (recommended: HSJ by Mersen)
Max. rated current	A	125	200
Circuit breaker			
Characteristics		-	-
Max. rated current	A	-	-
Earth-leakage circuit breaker			
3-phase mains connection		≥ 300 mA, type B	

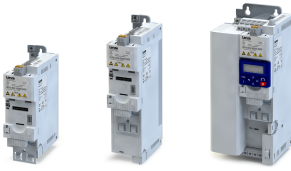

# Technical data

3-phase mains connection 400 V  
Fusing and terminal data

Mains connection					
Inverter		i550-C0.37/400-3 i550-C0.55/400-3 i550-C0.75/400-3 i550-C1.1/400-3 i550-C1.5/400-3 i550-C2.2/400-3	i550-C3.0/400-3 i550-C4.0/400-3 i550-C5.5/400-3	i550-C7.5/400-3 i550-C11/400-3	i550-C15/400-3 i550-C18/400-3 i550-C22/400-3
Connection		X100			
Connection type		pluggable screw terminal	Screw terminal		
Min. cable cross-section	mm <sup>2</sup>	1	1.5		
Max. cable cross-section	mm <sup>2</sup>	2.5	6	16	35
Stripping length	mm	8	9	11	18
Tightening torque	Nm	0.5		1.2	3.8
Required tool		0.5 x 3.0	0.6 x 3.5	0.8 x 4.0	0.8 x 5.5

Mains connection			
Inverter		i550-C30/400-3 i550-C37/400-3 i550-C45/400-3	i550-C55/400-3 i550-C75/400-3
Connection		X100	
Connection type		Screw terminal	
Min. cable cross-section	mm <sup>2</sup>	10	25
Max. cable cross-section	mm <sup>2</sup>	50	95
Stripping length	mm	19	22
Tightening torque	Nm	4	10
Required tool		Allen key 4.0	Allen key 6.0

PE				
Inverter		i550-C0.37/400-3 i550-C0.55/400-3 i550-C0.75/400-3 i550-C1.1/400-3 i550-C1.5/400-3 i550-C2.2/400-3 i550-C3.0/400-3 i550-C4.0/400-3 i550-C5.5/400-3	i550-C7.5/400-3 i550-C11/400-3	i550-C15/400-3 i550-C18/400-3 i550-C22/400-3 i550-C30/400-3 i550-C37/400-3 i550-C45/400-3 i550-C55/400-3 i550-C75/400-3
Connection		PE		
Connection type		PE screw		
Min. cable cross-section	mm <sup>2</sup>	1.5	2.5	4
Max. cable cross-section	mm <sup>2</sup>	6	16	25
Stripping length	mm	10	11	16
Tightening torque	Nm	2	3.4	4
Required tool		TORX TX20	PZ2	

Motor connection					
Inverter		i550-C0.37/400-3 i550-C0.55/400-3 i550-C0.75/400-3 i550-C1.1/400-3 i550-C1.5/400-3 i550-C2.2/400-3	i550-C3.0/400-3 i550-C4.0/400-3 i550-C5.5/400-3	i550-C7.5/400-3 i550-C11/400-3	i550-C15/400-3 i550-C18/400-3 i550-C22/400-3
Connection		X105			
Connection type		pluggable screw terminal	Screw terminal		
Min. cable cross-section	mm <sup>2</sup>	1	1.5		
Max. cable cross-section	mm <sup>2</sup>	2.5	6	16	35
Stripping length	mm	8	9	11	18
Tightening torque	Nm	0.5		1.2	3.8
Required tool		0.5 x 3.0	0.6 x 3.5	0.8 x 4.0	0.8 x 5.5

# Technical data

3-phase mains connection 400 V  
Fusing and terminal data



<b>Motor connection</b>			
<b>Inverter</b>		<b>i550-C30/400-3 i550-C37/400-3 i550-C45/400-3</b>	<b>i550-C55/400-3 i550-C75/400-3</b>
Connection		X105	
Connection type		Screw terminal	
Min. cable cross-section	mm <sup>2</sup>	10	25
Max. cable cross-section	mm <sup>2</sup>	50	95
Stripping length	mm	19	22
Tightening torque	Nm	4	10
Required tool		Allen key 4.0	Allen key 6.0

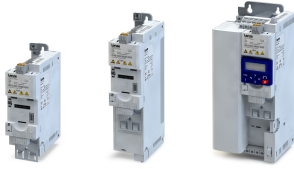

## Technical data

3-phase mains connection 400 V  
Brake resistors

### Brake resistors

Inverter	Brake resistor						
	Order code	Rated resistance	Rated power	Thermal capacity	Dimensions (h x b x t)	Weight	
		Ω	W	kWs	mm	kg	
i550-C0.37/400-3	ERBM390R100W	390	100	15	235 x 21 x 40	0.37	
i550-C0.55/400-3							
i550-C0.75/400-3							
i550-C1.1/400-3	ERBP180R200W	180	200	30	240 x 41 x 122	1	
	ERBP180R300W		300	45	320 x 41 x 122	1.4	
i550-C1.5/400-3	ERBP180R200W		200	30	240 x 41 x 122	1	
	ERBP180R300W		300	45	320 x 41 x 122	1.4	
i550-C2.2/400-3	ERBP180R200W		200	30	240 x 41 x 122	1	
	ERBP180R300W		300	45	320 x 41 x 122	1.4	
i550-C3.0/400-3	ERBP082R200W		82	200		30	666 x 124 x 122
	ERBS082R780W			780	117	3.6	
i550-C4.0/400-3	ERBP047R200W		47	200	30	320 x 41 x 122	1
	ERBS047R400W			400	60	400 x 110 x 105	2.3
	ERBS047R800W	800		120	710 x 110 x 105	4	
i550-C5.5/400-3	ERBP047R200W	200		30	320 x 41 x 122	1	
	ERBS047R400W	400		60	400 x 110 x 105	2.3	
	ERBS047R800W	800		120	710 x 110 x 105	4	
i550-C7.5/400-3	ERBP027R200W	27		200	30	320 x 41 x 122	1
	ERBS027R600W			600	90	550 x 110 x 105	3.1
	ERBS027R01K2			1200	180	1020 x 110 x 105	5.6
i550-C11/400-3	ERBP027R200W			200	30	320 x 41 x 122	1
	ERBS027R600W		600	90	550 x 110 x 105	3.1	
	ERBS027R01K2		1200	180	1020 x 110 x 105	5.6	
i550-C15/400-3	ERBS018R800W		18	800	120	710 x 110 x 105	3.9
	ERBS018R01K4			1400	210	1110 x 110 x 105	6.2
	ERBS018R02K8			2800	420	1110 x 200 x 105	12
	ERBG018R04K3			4300	645	486 x 426 x 302	13.5
i550-C18/400-3	ERBS015R800W	15	800	120	710 x 110 x 105	3.9	
	ERBS015R01K2		1200	180	1020 x 110 x 105	5.6	
	ERBS015R02K4		2400	420	1020 x 200 x 105	10	
	ERBG015R06K2		6200	930	486 x 526 x 302	17	
i550-C22/400-3	ERBS015R800W		800	120	710 x 110 x 105	3.9	
	ERBS015R01K2		1200	180	1020 x 110 x 105	5.6	
	ERBS015R02K4		2400	420	1020 x 200 x 105	10	
	ERBG015R06K2		6200	930	486 x 526 x 302	17	
i550-C30/400-3	ERBG075D01K9		7.5	1900	285	486 x 236 x 302	9.5
i550-C37/400-3							
i550-C45/400-3							
i550-C55/400-3	ERBG005R02K6	5	2600	390	486 x 326 x 302	11	
i550-C75/400-3							

# Technical data

3-phase mains connection 400 V  
Mains chokes



## Mains chokes

Inverter	Mains choke					
	Order code	Number of phases	Output current	Inductance	Dimensions (h x b x t)	Weight
			A	mH	mm	kg
i550-C0.37/400-3	EZAELN3002B203	3	1.5	19.6	56 x 77 x 100	0.52
i550-C0.55/400-3	EZAELN3002B153		2	14.7		0.53
i550-C0.75/400-3	EZAELN3004B742		4	7.35	60 x 95 x 115	1.31
i550-C1.1/400-3						
i550-C1.5/400-3	EZAELN3006B492		6	4.9	69 x 95 x 120	1.45
i550-C2.2/400-3						
i550-C3.0/400-3	EZAELN3008B372		8	3.68	85 x 120 x 140	1.9
i550-C4.0/400-3	EZAELN3010B292					10
i550-C5.5/400-3	EZAELN3016B182		16	1.84	95 x 120 x 140	2.7
i550-C7.5/400-3						
i550-C11/400-3	EZAELN3025B122		25	1.18	110 x 155 x 170	5.8
i550-C15/400-3	EZAELN3030B981					30
i550-C18/400-3	EZAELN3040B741		40	0.74	112 x 185 x 200	6.8
i550-C22/400-3	EZAELN3045B651					45
i550-C30/400-3	EZAELN3063B471		63	0.47	122 x 185 x 210	9.65
i550-C37/400-3	EZAELN3080B371					
i550-C45/400-3				80	0.37	125 x 210 x 240
i550-C55/400-3	EZAELN3100B301		100	0.3	139 x 267 x 205	16.5
i550-C75/400-3	EZAELN3160B191					





### RFI filters / Mains filters

Basic information on RFI filters, mains filters and EMC: from [163](#)

#### Maximum motor cable lengths and FI operation

Mains connection			3-phase, 400 V/480 V			
Inverter			i550-C0.37/400-3	i550-C0.55/400-3 i550-C0.75/400-3	i550-C1.1/400-3 i550-C1.5/400-3 i550-C2.2/400-3	i550-C3.0/400-3 i550-C4.0/400-3 i550-C5.5/400-3
Without RFI filter						
Without EMC category Thermal limitation	Max. motor cable length shielded	m	15	50	50	100
	Max. motor cable length unshielded	m	30	100	200	200
With integrated RFI filter						
Category C1	Max. motor cable length shielded	m	3	3	-	-
Category C2		m	15	20	20	20
	Earth-leakage circuit breaker	mA	30	30	30	300
RFI filter Low Leakage						
Category C1	Max. motor cable length shielded	m	-	-	-	-
	Earth-leakage circuit breaker	mA	-	-	-	-
RFI filter Short Distance						
Category C1	Max. motor cable length shielded	m	15	25	25	25
Category C2		m	15	50	50	50
	Earth-leakage circuit breaker	mA	30	30	30	30
RFI filter Long Distance						
Category C1	Max. motor cable length shielded	m	15	50	50	50
Category C2		m	15	50	50	100
	Earth-leakage circuit breaker	mA	300	300	300	300

# Technical data

3-phase mains connection 400 V  
RFI filters / Mains filters



Mains connection			3-phase, 400 V/480 V			
Inverter			i550-C7.5/400-3 i550-C11/400-3	i550-C15/400-3 i550-C18/400-3 i550-C22/400-3	i550-C30/400-3 i550-C37/400-3 i550-C45/400-3	i550-C55/400-3 i550-C75/400-3
Without RFI filter						
Without EMC category	Max. motor cable length shielded	m	100	100	100	100
Thermal limitation	Max. motor cable length unshielded	m	200	200	200	200
With integrated RFI filter						
Category C1	Max. motor cable length shielded	m	-	-	-	-
Category C2		m	20	20	20	20
	Earth-leakage circuit breaker	mA	300	300	300	300
RFI filter Low Leakage						
Category C1	Max. motor cable length shielded	m	-	-	-	-
	Earth-leakage circuit breaker	mA	-	-	-	-
RFI filter Short Distance						
Category C1	Max. motor cable length shielded	m	25	-	-	-
Category C2		m	50	-	-	-
	Earth-leakage circuit breaker	mA	30	-	-	-
RFI filter Long Distance				<i>from 22 kW: Mains filter</i>		
Category C1	Max. motor cable length shielded	m	50	50	50	50
Category C2		m	100	50	50	50
	Earth-leakage circuit breaker	mA	300	300	300	300



## Technical data

3-phase mains connection 400 V  
RFI filters / Mains filters

### Short Distance

Inverter	RFI filter			
	Order code	Output current	Dimensions (h x b x t)	Weight
		A	mm	kg
i550-C0.37/400-3	I0FAE175F100S0000S	3.3	276 x 60 x 50	0.9
i550-C0.55/400-3				
i550-C0.75/400-3				
i550-C1.1/400-3	I0FAE222F100S0000S	7.3	346 x 60 x 50	1.1
i550-C1.5/400-3				
i550-C2.2/400-3				
i550-C3.0/400-3	I0FAE255F100S0000S	18	346 x 90 x 60	2.1
i550-C4.0/400-3				
i550-C5.5/400-3				
i550-C7.5/400-3				
i550-C11/400-3	I0FAE311F100S0000S	29	371 x 120 x 60	2.4

### Long Distance

Inverter	RFI filter			
	Order code	Output current	Dimensions (h x b x t)	Weight
		A	mm	kg
i550-C0.37/400-3	I0FAE175F100D0000S	3.3	276 x 60 x 50	0.9
i550-C0.55/400-3				
i550-C0.75/400-3				
i550-C1.1/400-3	I0FAE222F100D0000S	7.3	346 x 60 x 50	1.1
i550-C1.5/400-3				
i550-C2.2/400-3				
i550-C3.0/400-3	I0FAE255F100D0000S	18	346 x 90 x 60	1.7
i550-C4.0/400-3				
i550-C5.5/400-3				
i550-C7.5/400-3				
i550-C11/400-3	I0FAE311F100D0000S	29	371 x 120 x 60	2
i550-C15/400-3	E84AZESR1834LD	50.4	436 x 205 x 90	7.5
i550-C18/400-3				
i550-C22/400-3	E84AZESM2234LD	42	590 x 250 x 105	14
i550-C30/400-3	E84AZESM3034LD	55		23
i550-C37/400-3	E84AZESM3734LD	68		25
i550-C45/400-3	E84AZESM4534LD	80		30

From 22 kW, long distance mains filters are used. Mains filters are a combination of mains choke and RFI filter.

# Technical data

3-phase mains connection 400 V  
Sine filter

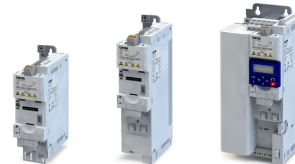

## Sine filter

Inverter		Sine filter		
	Switching frequency	Order code	Rated inductance	Max. output frequency
	kHz		mH	Hz
i550-C0.37/400-3	4 8	EZS3-004A200	11.0	150
i550-C0.55/400-3				
i550-C0.75/400-3				
i550-C1.1/400-3		EZS3-010A200	5.10	
i550-C1.5/400-3				
i550-C2.2/400-3				
i550-C3.0/400-3		EZS3-017A200	3.07	
i550-C4.0/400-3				
i550-C5.5/400-3				
i550-C7.5/400-3		EZS3-024A200	2.50	
i550-C11/400-3		EZS3-032A200	2.00	
i550-C15/400-3		EZS3-037A200	1.70	
i550-C18/400-3		EZS3-048A200	1.20	
i550-C22/400-3		EZS3-048A200	1.20	
i550-C30/400-3		EZS3-061A200	1.00	
i550-C37/400-3		EZS3-090A200	0.8	
i550-C45/400-3		EZS3-090A200	0.8	
i550-C55/400-3		EZS3-115A200	0.7	
i550-C75/400-3	EZS3-150A200	0.5		



### 3-phase mains connection 400 V "light duty"

#### Rated data

The output currents apply to these operating conditions:

- At a switching frequency of 2 kHz or 4 kHz: Ambient temperature above 40 °C with a rated output current reduced by 2.5 %/°C.
- If the load characteristic "Light Duty" and the switching frequencies 8 kHz or 16 kHz are selected, only the values of the load characteristic "Heavy Duty" are reached.

Inverter		i550-C3.0/400-3	i550-C4.0/400-3	i550-C5.5/400-3	i550-C7.5/400-3
<b>Rated power</b>	<b>kW</b>	<b>4</b>	<b>5.5</b>	<b>7.5</b>	<b>11</b>
Mains voltage range		3/PE AC 340 V ... 528 V, 45 Hz ... 65 Hz			
Output voltage		3 AC 0 V ... 400 V			
Rated mains current					
without mains choke	A	10.3	14	18.3	28
with mains choke	A	8.2	11	14.5	22
Apparent output power	kVA	5.9	8	10.5	15
Output current					
2 kHz	A	8.8	11.9	15.6	23
4 kHz	A	8.8	11.9	15.6	23
Power loss					
4 kHz	W	100	133	173	253
at controller inhibit	W	6	6	6	6
Overcurrent cycle 180 s					
Max. output current	A	11	14.3	19.5	23.6
Overload time	s	60	60	60	60
Recovery time	s	120	120	120	120
Max. output current during the recovery time	A	5.5	7.1	9.8	12.4
Overcurrent cycle 15 s					
Max. output current	A	14.6	19	26	33
Overload time	s	3	3	3	3
Recovery time	s	12	12	12	12
Max. output current during the recovery time	A	5.5	7.1	9.8	12.4
Cyclic mains switching		3 times per minute			
Brake chopper					
Max. output current	A	9.5	16.6	16.6	29
Min. brake resistance	Ω	82	47	47	27
Max. motor cable length shielded					
without EMC category	m	50			100
Category C2	m	20			
Weight	kg	2.3			3.7

# Technical data

3-phase mains connection 400 V "light duty"

Rated data



Inverter		i550-C11/400-3	i550-C15/400-3	i550-C18/400-3	i550-C22/400-3
<b>Rated power</b>	<b>kW</b>	<b>15</b>	<b>18.5</b>	<b>22</b>	<b>30</b>
Mains voltage range		3/PE AC 340 V ... 528 V, 45 Hz ... 65 Hz			
Output voltage		3 AC 0 V ... 400 V			
Rated mains current					
without mains choke	A	-	48	-	-
with mains choke	A	27.1	36	43	55
Apparent output power	kVA	19	26	32	38
Output current					
2 kHz	A	28.2	38.4	48	56.4
4 kHz	A	28.2	38.4	48	56.4
Power loss					
4 kHz	W	309	430	533	623
at controller inhibit	W	6	18	18	18
Overcurrent cycle 180 s					
Max. output current	A	35	48	60	71
Overload time	s	60	60	60	60
Recovery time	s	120	120	120	120
Max. output current during the recovery time	A	17.6	24	30	35
Overcurrent cycle 15 s					
Max. output current	A	47	64	80	94
Overload time	s	3	3	3	3
Recovery time	s	12	12	12	12
Max. output current during the recovery time	A	17.6	24	30	35
Cyclic mains switching		3 times per minute			
Brake chopper					
Max. output current	A	29	43	52	52
Min. brake resistance	Ω	27	18	15	15
Max. motor cable length shielded					
without EMC category	m	100			
Category C2	m	20			
Weight	kg	3.7	10.3		



# Technical data

3-phase mains connection 400 V "light duty"  
Rated data

Inverter		i550-C30/400-3	i550-C37/400-3	i550-C45/400-3	i550-C55/400-3
<b>Rated power</b>	<b>kW</b>	<b>37</b>	<b>45</b>	<b>55</b>	<b>75</b>
Mains voltage range		3/PE AC 340 V ... 528 V, 45 Hz ... 65 Hz			
Output voltage		3 AC 0 V ... 400 V			
Rated mains current					
without mains choke	A	-	-	-	-
with mains choke	A	69	86	100	119
Apparent output power	kVA	49	61	72	89
Output current					
2 kHz	A	73.2	91.2	107	132
4 kHz	A	73.2	91.2	107	132
Power loss					
4 kHz	W	810	1004	1171	1446
at controller inhibit	W	25	25	25	30
Overcurrent cycle 180 s					
Max. output current	A	92	114	134	165
Overload time	s	60	60	60	60
Recovery time	s	120	120	120	120
Max. output current during the recovery time	A	46	57	67	83
Overcurrent cycle 15 s					
Max. output current	A	122	152	178	220
Overload time	s	3	3	3	3
Recovery time	s	12	12	12	12
Max. output current during the recovery time	A	46	57	67	83
Cyclic mains switching		3 times per minute			1 time per minute
Brake chopper					
Max. output current	A	98	98	98	166
Min. brake resistance	Ω	7.5	7.5	7.5	4.7
Max. motor cable length shielded					
without EMC category	m	100			
Category C2	m	20			
Weight	kg	17.2			24

# Technical data

3-phase mains connection 400 V "light duty"

Rated data

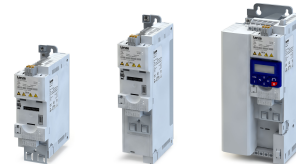

Inverter		i550-C75/400-3
<b>Rated power</b>	<b>kW</b>	<b>90</b>
Mains voltage range		3/PE AC 340 V ... 528 V, 45 Hz ... 65 Hz
Output voltage		3 AC 0 V ... 400 V
Rated mains current		
without mains choke	A	-
with mains choke	A	160
Apparent output power	kVA	121
Output current		
2 kHz	A	180
4 kHz	A	180
Power loss		
4 kHz	W	1961
at controller inhibit	W	30
Overcurrent cycle 180 s		
Max. output current	A	225
Overload time	s	60
Recovery time	s	120
Max. output current during the recovery time	A	113
Overcurrent cycle 15 s		
Max. output current	A	300
Overload time	s	3
Recovery time	s	12
Max. output current during the recovery time	A	113
Cyclic mains switching		1 time per minute
Brake chopper		
Max. output current	A	166
Min. brake resistance	Ω	4.7
Max. motor cable length shielded		
without EMC category	m	100
Category C2	m	20
Weight	kg	24



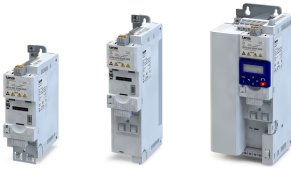

# Technical data

3-phase mains connection 400 V "light duty"  
Fusing and terminal data

## Fusing and terminal data

Fuse data					
Inverter		i550-C3.0/400-3 i550-C4.0/400-3 i550-C5.5/400-3	i550-C7.5/400-3	i550-C11/400-3	i550-C15/400-3
Cable installation in compliance with		EN 60204-1			
Installation method		B2			
operation		without mains choke			without mains choke
Fuse					
Characteristics		gG/gL or gRL		-	gG/gL or gRL
Max. rated current	A	25	32	-	63
Circuit breaker					
Characteristics		B		-	B
Max. rated current	A	25	32	-	63
operation		with mains choke			
Fuse					
Characteristics		gG/gL or gRL			
Max. rated current	A	25	32	32	63
Circuit breaker					
Characteristics		B			
Max. rated current	A	25	32	32	63
Earth-leakage circuit breaker					
3-phase mains connection		≥ 300 mA, type B			

Fuse data					
Inverter		i550-C18/400-3 i550-C22/400-3	i550-C30/400-3	i550-C37/400-3	i550-C45/400-3
Cable installation in compliance with		EN 60204-1			
Installation method		B2	C		
operation					
Fuse					
Characteristics		-			
Max. rated current	A	-	-	-	-
Circuit breaker					
Characteristics		-			
Max. rated current	A	-	-	-	-
operation		with mains choke			
Fuse					
Characteristics		gG/gL or gRL			
Max. rated current	A	63	80	100	125
Circuit breaker					
Characteristics		B			
Max. rated current	A	63	80	100	125
Earth-leakage circuit breaker					
3-phase mains connection		≥ 300 mA, type B			

# Technical data

3-phase mains connection 400 V "light duty"  
Fusing and terminal data

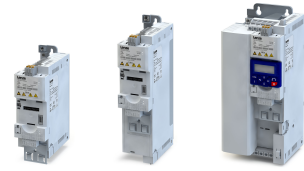

Fuse data				
Inverter		i550-C55/400-3 i550-C75/400-3	i550-C90/400-3	
Cable installation in compliance with		EN 60204-1		
Installation method		F		
operation				
Fuse				
Characteristics		-		
Max. rated current	A	-	-	
Circuit breaker				
Characteristics		-		
Max. rated current	A	-	-	
operation		with mains choke		
Fuse				
Characteristics		gR		
Max. rated current	A	160	300	
Circuit breaker				
Characteristics		-		
Max. rated current	A	-	-	
Earth-leakage circuit breaker				
3-phase mains connection		≥ 300 mA, type B		

Fuse data							
Inverter		i550-C3.0/400-3 i550-C4.0/400-3 i550-C5.5/400-3	i550-C7.5/400-3	i550-C11/400-3	i550-C15/400-3		
Cable installation in compliance with		US National Electrical Code NFPA 70 / Canadian Electrical Code C22.1					
operation		without mains choke			without mains choke		
Fuse							
Characteristics		all acc. to UL 248 / Class CC	all acc. to UL 248 / Class J, T, R	-	all acc. to UL 248 / Class J, T, R		
Max. rated current	A	25	40	-	70		
Circuit breaker							
Characteristics		-					
Max. rated current	A	25	35	-	-		
operation		with mains choke					
Fuse							
Characteristics		all acc. to UL 248 / Class CC	all acc. to UL 248 / Class J, T, R				
Max. rated current	A	25	40	40	70		
Circuit breaker							
Characteristics		-					
Max. rated current	A	25	35	-	-		
Earth-leakage circuit breaker							
3-phase mains connection		≥ 300 mA, type B					



# Technical data

3-phase mains connection 400 V "light duty"  
Fusing and terminal data

Fuse data					
Inverter		i550-C18/400-3 i550-C22/400-3	i550-C30/400-3	i550-C37/400-3	i550-C45/400-3
Cable installation in compliance with operation		US National Electrical Code NFPA 70 / Canadian Electrical Code C22.1			
Fuse					
Characteristics		-			
Max. rated current	A	-	-	-	-
Circuit breaker					
Characteristics		-	-	-	-
Max. rated current	A	-	-	-	-
operation		with mains choke			
Fuse					
Characteristics		all acc. to UL 248 / Class J, T, R			
Max. rated current	A	70	80	100	125
Circuit breaker					
Characteristics		-	-	-	-
Max. rated current	A	-	-	-	-
Earth-leakage circuit breaker					
3-phase mains connection		≥ 300 mA, type B			

Fuse data			
Inverter		i550-C55/400-3 i550-C75/400-3	i550-C90/400-3
Cable installation in compliance with operation		US National Electrical Code NFPA 70 / Canadian Electrical Code C22.1	
Fuse			
Characteristics		-	
Max. rated current	A	-	-
Circuit breaker			
Characteristics		-	-
Max. rated current	A	-	-
operation		with mains choke	
Fuse			
Characteristics		acc. to UL 248 / Class J (recommended: HSJ by Mersen)	all acc. to UL 248 / Class J, T, R
Max. rated current	A	200	300
Circuit breaker			
Characteristics		-	-
Max. rated current	A	-	-
Earth-leakage circuit breaker			
3-phase mains connection		≥ 300 mA, type B	

# Technical data

3-phase mains connection 400 V "light duty"  
Fusing and terminal data



Mains connection					
Inverter		i550-C3.0/400-3 i550-C4.0/400-3 i550-C5.5/400-3	i550-C7.5/400-3 i550-C11/400-3	i550-C15/400-3 i550-C18/400-3 i550-C22/400-3	i550-C30/400-3 i550-C37/400-3 i550-C45/400-3
Connection		X100			
Connection type		Screw terminal			
Min. cable cross-section	mm <sup>2</sup>	1.5			10
Max. cable cross-section	mm <sup>2</sup>	6	16	35	50
Stripping length	mm	9	11	18	19
Tightening torque	Nm	0.5	1.2	3.8	4
Required tool		0.6 x 3.5	0.8 x 4.0	0.8 x 5.5	Allen key 4.0

Mains connection			
Inverter		i550-C55/400-3 i550-C75/400-3	i550-C90/400-3
Connection		X100	
Connection type		Screw terminal	
Min. cable cross-section	mm <sup>2</sup>	25	35
Max. cable cross-section	mm <sup>2</sup>	95	150
Stripping length	mm	22	28
Tightening torque	Nm	10	18
Required tool		Allen key 6.0	Allen key 8.0

Motor connection					
Inverter		i550-C3.0/400-3 i550-C4.0/400-3 i550-C5.5/400-3	i550-C7.5/400-3 i550-C11/400-3	i550-C15/400-3 i550-C18/400-3 i550-C22/400-3	i550-C30/400-3 i550-C37/400-3 i550-C45/400-3
Connection		X105			
Connection type		Screw terminal			
Min. cable cross-section	mm <sup>2</sup>	1.5			10
Max. cable cross-section	mm <sup>2</sup>	6	16	35	50
Stripping length	mm	9	11	18	19
Tightening torque	Nm	0.5	1.2	3.8	4
Required tool		0.6 x 3.5	0.8 x 4.0	0.8 x 5.5	Allen key 4.0

Motor connection			
Inverter		i550-C55/400-3 i550-C75/400-3	i550-C90/400-3
Connection		X105	
Connection type		Screw terminal	
Min. cable cross-section	mm <sup>2</sup>	25	35
Max. cable cross-section	mm <sup>2</sup>	95	150
Stripping length	mm	22	28
Tightening torque	Nm	10	18
Required tool		Allen key 6.0	Allen key 8.0



## Technical data

3-phase mains connection 400 V "light duty"  
Mains chokes

### Brake resistors

Inverter	Brake resistor					
	Order code	Rated resistance	Rated power	Thermal capacity	Dimensions (h x b x t)	Weight
		Ω	W	kWs	mm	kg
i550-C3.0/400-3	ERBP082R200W	82	200	30	320 x 41 x 122	1
	ERBS082R780W		780	117	666 x 124 x 122	3.6
i550-C4.0/400-3	ERBP047R200W	47	200	30	320 x 41 x 122	1
	ERBS047R400W		400	60	400 x 110 x 105	2.3
	ERBS047R800W		800	120	710 x 110 x 105	4
i550-C5.5/400-3	ERBP047R200W	47	200	30	320 x 41 x 122	1
	ERBS047R400W		400	60	400 x 110 x 105	2.3
	ERBS047R800W		800	120	710 x 110 x 105	4
i550-C7.5/400-3	ERBP027R200W	27	200	30	320 x 41 x 122	1
	ERBS027R600W		600	90	550 x 110 x 105	3.1
	ERBS027R01K2		1200	180	1020 x 110 x 105	5.6
i550-C11/400-3	ERBP027R200W	27	200	30	320 x 41 x 122	1
	ERBS027R600W		600	90	550 x 110 x 105	3.1
	ERBS027R01K2		1200	180	1020 x 110 x 105	5.6
i550-C15/400-3	ERBS018R800W	18	800	120	710 x 110 x 105	3.9
	ERBS018R01K4		1400	210	1110 x 110 x 105	6.2
	ERBS018R02K8		2800	420	1110 x 200 x 105	12
	ERBG018R04K3		4300	645	486 x 426 x 302	13.5
i550-C18/400-3	ERBS015R800W	15	800	120	710 x 110 x 105	3.9
	ERBS015R01K2		1200	180	1020 x 110 x 105	5.6
	ERBS015R02K4		2400	420	1020 x 200 x 105	10
	ERBG015R06K2		6200	930	486 x 526 x 302	17
i550-C22/400-3	ERBS015R800W	15	800	120	710 x 110 x 105	3.9
	ERBS015R01K2		1200	180	1020 x 110 x 105	5.6
	ERBS015R02K4		2400	420	1020 x 200 x 105	10
	ERBG015R06K2		6200	930	486 x 526 x 302	17
i550-C30/400-3	ERBG075D01K9	7.5	1900	285	486 x 236 x 302	9.5
i550-C37/400-3						
i550-C45/400-3						
i550-C55/400-3	ERBG005R02K6	5	2600	390	486 x 326 x 302	11
i550-C75/400-3						

### Mains chokes

Inverter	Mains choke					
	Order code	Number of phases	Output current	Inductance	Dimensions (h x b x t)	Weight
			A	mH	mm	kg
i550-C3.0/400-3	EZAELN3010B292	3	10	2.94	85 x 120 x 140	2
i550-C4.0/400-3			16	1.84	95 x 120 x 140	2.7
i550-C5.5/400-3			25	1.18	110 x 155 x 170	5.8
i550-C7.5/400-3	EZAELN3025B122	3	30	0.98	112 x 185 x 200	5.85
i550-C11/400-3			40	0.74		6.8
i550-C15/400-3	EZAELN3040B741	3	45	0.65	122 x 185 x 210	8.25
i550-C18/400-3			63	0.47		9.65
i550-C30/400-3	EZAELN3080B371	3	80	0.37	125 x 210 x 240	12.5
i550-C37/400-3			90	0.33	115 x 267 x 205	11.5
i550-C45/400-3	EZAELN3100B301	3	100	0.3	139 x 267 x 205	16.5
i550-C55/400-3			125	0.24	139 x 291 x 215	17.5
i550-C75/400-3	EZAELN3160B191	3	160	0.19	149 x 291 x 215	22.5

# Technical data

3-phase mains connection 400 V "light duty"  
RFI filters / Mains filters



## RFI filters / Mains filters

Basic information on RFI filters, mains filters and EMC: from [163](#)

### Maximum motor cable lengths and FI operation

Mains connection			3-phase, 400 V/480 V, Light Duty			
Inverter			i550-C3.0/400-3 i550-C4.0/400-3 i550-C5.5/400-3	i550-C7.5/400-3 i550-C11/400-3	i550-C15/400-3 i550-C18/400-3 i550-C22/400-3	i550-C30/400-3 i550-C37/400-3 i550-C45/400-3 i550-C55/400-3 i550-C75/400-3
Without RFI filter						
Without EMC category Thermal limitation	Max. motor cable length shielded	m	100	100	100	100
	Max. motor cable length unshielded	m	200	200	200	200
With integrated RFI filter						
Category C1	Max. motor cable length shielded	m	-	-	-	-
Category C2		m	20	20	20	20
	Earth-leakage circuit breaker	mA	300	300	300	300
RFI filter Low Leakage						
Category C1	Max. motor cable length shielded	m	-	-	-	-
	Earth-leakage circuit breaker	mA	-	-	-	-
RFI filter Short Distance						
Category C1	Max. motor cable length shielded	m	25	25	-	-
Category C2		m	50	50	-	-
	Earth-leakage circuit breaker	mA	30	30	-	-
RFI filter Long Distance						
Category C1	Max. motor cable length shielded	m	50	50	-	-
Category C2		m	100	100	-	-
	Earth-leakage circuit breaker	mA	300	300	-	-

### Short Distance

Inverter	RFI filter			
	Order code	Output current	Dimensions (h x b x t)	Weight
		A	mm	kg
i550-C3.0/400-3	I0FAE255F100S0000S	18	346 x 90 x 60	2.1
i550-C4.0/400-3				
i550-C5.5/400-3				
i550-C7.5/400-3	I0FAE311F100S0000S	29	371 x 120 x 60	2.4
i550-C11/400-3				

### Long Distance

Inverter	RFI filter			
	Order code	Output current	Dimensions (h x b x t)	Weight
		A	mm	kg
i550-C3.0/400-3	I0FAE255F100D0000S	18	346 x 90 x 60	1.7
i550-C4.0/400-3				
i550-C5.5/400-3				
i550-C7.5/400-3	I0FAE311F100D0000S	29	371 x 120 x 60	2
i550-C11/400-3				



# Technical data

3-phase mains connection 400 V "light duty"  
Sine filter

## Sine filter

Inverter		Sine filter			
	Switching frequency	Order code	Rated inductance	Max. output frequency	
	kHz		mH	Hz	
i550-C3.0/400-3	4	EZS3-010A200	5.10	150	
i550-C4.0/400-3		EZS3-017A200	3.07		
i550-C5.5/400-3		EZS3-024A200	2.50		
i550-C7.5/400-3		EZS3-032A200	2.00		
i550-C11/400-3		EZS3-048A200	1.20		
i550-C15/400-3		EZS3-048A200	1.20		
i550-C18/400-3		EZS3-061A200	1.00		
i550-C22/400-3		EZS3-090A200	0.8		
i550-C30/400-3		EZS3-090A200	0.8		
i550-C37/400-3		EZS3-115A200	0.7		
i550-C45/400-3		EZS3-150A200	0.5		
i550-C55/400-3		EZS3-180A200	0.4		90
i550-C75/400-3					

# Technical data

3-phase mains connection 480 V  
Rated data



## 3-phase mains connection 480 V

### Rated data

The output currents apply to these operating conditions:

- At a switching frequency of 2 kHz or 4 kHz: Max. ambient temperature 45°C.
- At a switching frequency of 8 kHz or 16 kHz: Max. ambient temperature 40 °C.

Inverter		i550-C0.37/400-3	i550-C0.55/400-3	i550-C0.75/400-3	i550-C1.1/400-3
<b>Rated power</b>	<b>kW</b>	<b>0.37</b>	<b>0.55</b>	<b>0.75</b>	<b>1.1</b>
Mains voltage range		3/PE AC 340 V ... 528 V, 45 Hz ... 65 Hz			
Output voltage		3 AC 0 V ... 480 V			
Rated mains current					
without mains choke	A	1.5	2.1	2.8	3.7
with mains choke	A	1.2	1.7	2.2	2.5
Apparent output power	kVA	0.9	1.2	1.6	2.2
Output current					
2 kHz	A	-	1.6	2.1	3
4 kHz	A	1.1	1.6	2.1	3
8 kHz	A	1.1	1.6	2.1	3
16 kHz	A	0.7	1.1	1.4	2
Power loss					
4 kHz	W	20	25	32	40
8 kHz	W	24	31	40	51
at controller inhibit	W	6	6	6	6
Overcurrent cycle 180 s					
Max. output current	A	1.7	2.4	3.2	4.5
Overload time	s	60	60	60	60
Recovery time	s	120	120	120	120
Max. output current during the recovery time	A	0.8	1.2	1.6	2.3
Overcurrent cycle 15 s					
Max. output current	A	2.2	3.2	4.2	6
Overload time	s	3	3	3	3
Recovery time	s	12	12	12	12
Max. output current during the recovery time	A	0.8	1.2	1.6	2.3
Cyclic mains switching		3 times per minute			
Brake chopper					
Max. output current	A	2	2	2	4.3
Min. brake resistance	Ω	390	390	390	180
Max. motor cable length shielded					
without EMC category	m	15	50		
Category C1 (2 kHz, 4 kHz, 8 kHz)	m	3			-
Category C2	m	15	20		
Weight	kg	0.8	1		1.35



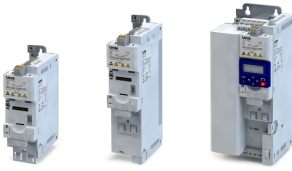

# Technical data

3-phase mains connection 480 V  
Rated data

Inverter		i550-C1.5/400-3	i550-C2.2/400-3	i550-C3.0/400-3	i550-C4.0/400-3
<b>Rated power</b>	<b>kW</b>	<b>1.5</b>	<b>2.2</b>	<b>3</b>	<b>4</b>
Mains voltage range		3/PE AC 340 V ... 528 V, 45 Hz ... 65 Hz			
Output voltage		3 AC 0 V ... 480 V			
Rated mains current					
without mains choke	A	4.5	6.5	8	10.5
with mains choke	A	3.1	4.4	5.8	7.5
Apparent output power	kVA	2.6	3.8	4.9	6.4
Output current					
2 kHz	A	3.5	4.8	6.3	8.2
4 kHz	A	3.5	4.8	6.3	8.2
8 kHz	A	3.5	4.8	6.3	8.2
16 kHz	A	2.3	3.2	4.2	5.5
Power loss					
4 kHz	W	48	66	85	110
8 kHz	W	61	85	110	140
at controller inhibit	W	6	6	6	6
Overcurrent cycle 180 s					
Max. output current	A	5.3	7.2	9.5	12.3
Overload time	s	60	60	60	60
Recovery time	s	120	120	120	120
Max. output current during the recovery time	A	2.6	3.6	4.8	6.2
Overcurrent cycle 15 s					
Max. output current	A	7	9.6	12.6	16.4
Overload time	s	3	3	3	3
Recovery time	s	12	12	12	12
Max. output current during the recovery time	A	2.6	3.6	4.7	6.2
Cyclic mains switching		3 times per minute			
Brake chopper					
Max. output current	A	4.3	4.3	9.5	16.6
Min. brake resistance	Ω	180	150	82	47
Max. motor cable length shielded					
without EMC category	m	50			
Category C1 (2 kHz, 4 kHz, 8 kHz)	m	-			
Category C2	m	20			
Weight	kg	1.35		2.3	

# Technical data

3-phase mains connection 480 V

Rated data

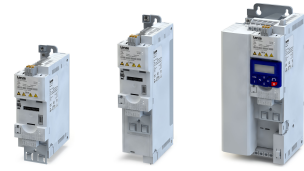

Inverter		i550-C5.5/400-3	i550-C7.5/400-3	i550-C11/400-3	i550-C15/400-3
<b>Rated power</b>	<b>kW</b>	<b>5.5</b>	<b>7.5</b>	<b>11</b>	<b>15</b>
Mains voltage range		3/PE AC 340 V ... 528 V, 45 Hz ... 65 Hz			
Output voltage		3 AC 0 V ... 480 V			
Rated mains current					
without mains choke	A	14.3	16.6	23.7	32.3
with mains choke	A	10.3	13.1	18.6	24
Apparent output power	kVA	8.7	11	16	22
Output current					
2 kHz	A	11	14	21	27
4 kHz	A	11	14	21	27
8 kHz	A	11	14	21	27
16 kHz	A	7.3	9.3	14	18
Power loss					
4 kHz	W	145	185	260	360
8 kHz	W	190	240	340	460
at controller inhibit	W	6	6	6	18
Overcurrent cycle 180 s					
Max. output current	A	16.5	21	31.5	40.5
Overload time	s	60	60	60	60
Recovery time	s	120	120	120	120
Max. output current during the recovery time	A	8.3	10.5	15.8	20.3
Overcurrent cycle 15 s					
Max. output current	A	22	28	42	54
Overload time	s	3	3	3	3
Recovery time	s	12	12	12	12
Max. output current during the recovery time	A	8.3	10.5	15.8	20.3
Cyclic mains switching		3 times per minute			
Brake chopper					
Max. output current	A	16.6	29	29	43
Min. brake resistance	Ω	47	27	27	18
Max. motor cable length shielded					
without EMC category	m	50	100		
Category C1 (2 kHz, 4 kHz, 8 kHz)	m	-			
Category C2	m	20			
Weight	kg	2.3	3.7		10.3

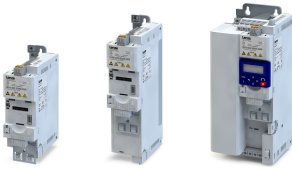

# Technical data

3-phase mains connection 480 V  
Rated data

Inverter		i550-C18/400-3	i550-C22/400-3	i550-C30/400-3	i550-C37/400-3
<b>Rated power</b>	<b>kW</b>	<b>18.5</b>	<b>22</b>	<b>30</b>	<b>37</b>
Mains voltage range		3/PE AC 340 V ... 528 V, 45 Hz ... 65 Hz			
Output voltage		3 AC 0 V ... 480 V			
Rated mains current					
without mains choke	A	40.3	47.4	-	-
with mains choke	A	30	35.3	45.7	57
Apparent output power	kVA	27	32	41	51
Output current					
2 kHz	A	34	40.4	52	65
4 kHz	A	34	40.4	52	65
8 kHz	A	34	40.4	52	65
16 kHz	A	22.6	26.9	34.7	43.4
Power loss					
4 kHz	W	450	520	680	840
8 kHz	W	570	670	880	1100
at controller inhibit	W	18	18	25	25
Overcurrent cycle 180 s					
Max. output current	A	51	61	78	98
Overload time	s	60	60	60	60
Recovery time	s	120	120	120	120
Max. output current during the recovery time	A	25.5	30	39	49
Overcurrent cycle 15 s					
Max. output current	A	68	81	104	130
Overload time	s	3	3	3	3
Recovery time	s	12	12	12	12
Max. output current during the recovery time	A	25.5	30	39	49
Cyclic mains switching		3 times per minute			
Brake chopper					
Max. output current	A	52	52	98	98
Min. brake resistance	Ω	15	15	7.5	7.5
Max. motor cable length shielded					
without EMC category	m	100			
Category C1 (2 kHz, 4 kHz, 8 kHz)	m	-			
Category C2	m	20			
Weight	kg	10.3		17.2	

# Technical data

3-phase mains connection 480 V

Rated data

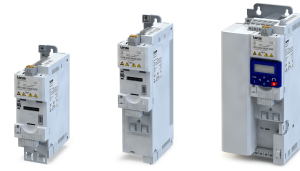

Inverter		i550-C45/400-3	i550-C55/400-3	i550-C75/400-3
<b>Rated power</b>	<b>kW</b>	<b>45</b>	<b>55</b>	<b>75</b>
Mains voltage range		3/PE AC 340 V ... 528 V, 45 Hz ... 65 Hz		
Output voltage		3 AC 0 V ... 480 V		
Rated mains current				
without mains choke	A	-	-	-
with mains choke	A	66.7	83	113
Apparent output power	kVA	60	75	100
Output current				
2 kHz	A	77	96	124
4 kHz	A	77	96	124
8 kHz	A	77	96	124
16 kHz	A	51.4	64	82.7
Power loss				
4 kHz	W	980	1210	1640
8 kHz	W	1280	1580	2140
at controller inhibit	W	25	30	30
Overcurrent cycle 180 s				
Max. output current	A	116	144	186
Overload time	s	60	60	60
Recovery time	s	120	120	120
Max. output current during the recovery time	A	58	72	93
Overcurrent cycle 15 s				
Max. output current	A	154	192	248
Overload time	s	3	3	3
Recovery time	s	12	12	12
Max. output current during the recovery time	A	58	72	93
Cyclic mains switching		3 times per minute	1 time per minute	
Brake chopper				
Max. output current	A	98	166	166
Min. brake resistance	Ω	7.5	4.7	4.7
Max. motor cable length shielded				
without EMC category	m	100		
Category C1 (2 kHz, 4 kHz, 8 kHz)	m	-		
Category C2	m	20		
Weight	kg	17.2	24	



# Technical data

3-phase mains connection 480 V  
Fusing and terminal data

## Fusing and terminal data

Fuse data					
Inverter		i550-C0.37/400-3 i550-C0.55/400-3 i550-C0.75/400-3	i550-C1.1/400-3 i550-C1.5/400-3 i550-C2.2/400-3	i550-C3.0/400-3 i550-C4.0/400-3 i550-C5.5/400-3	i550-C7.5/400-3 i550-C11/400-3
Cable installation in compliance with		EN 60204-1			
Installation method		B2			
operation		without mains choke			
Fuse		gG/gL or gRL			
Characteristics		gG/gL or gRL			
Max. rated current	A	10	16	25	32
Circuit breaker		B			
Characteristics		B			
Max. rated current	A	10	16	25	32
operation		with mains choke			
Fuse		gG/gL or gRL			
Characteristics		gG/gL or gRL			
Max. rated current	A	10	16	25	32
Circuit breaker		B			
Characteristics		B			
Max. rated current	A	10	16	25	32
Earth-leakage circuit breaker					
3-phase mains connection		≥ 30 mA, type B		≥ 300 mA, type B	

Fuse data					
Inverter		i550-C15/400-3 i550-C18/400-3 i550-C22/400-3	i550-C30/400-3	i550-C37/400-3	i550-C45/400-3
Cable installation in compliance with		EN 60204-1			
Installation method		B2	C		
operation		without mains choke			
Fuse		gG/gL or gRL			
Characteristics		gG/gL or gRL	-		
Max. rated current	A	63	-	-	-
Circuit breaker		B			
Characteristics		B	-		
Max. rated current	A	63	-	-	-
operation		with mains choke			
Fuse		gG/gL or gRL			
Characteristics		gG/gL or gRL			
Max. rated current	A	63	80	100	125
Circuit breaker		B			
Characteristics		B			
Max. rated current	A	63	80	100	125
Earth-leakage circuit breaker					
3-phase mains connection		≥ 300 mA, type B			

# Technical data

3-phase mains connection 480 V  
Fusing and terminal data



Fuse data		
Inverter		i550-C55/400-3 i550-C75/400-3
Cable installation in compliance with		EN 60204-1
Installation method		F
operation		
Fuse		
Characteristics		-
Max. rated current	A	-
Circuit breaker		
Characteristics		-
Max. rated current	A	-
operation		with mains choke
Fuse		
Characteristics		gR
Max. rated current	A	160
Circuit breaker		
Characteristics		-
Max. rated current	A	-
Earth-leakage circuit breaker		
3-phase mains connection		≥ 300 mA, type B

Fuse data					
Inverter		i550-C0.37/400-3 i550-C0.55/400-3 i550-C0.75/400-3 i550-C1.1/400-3 i550-C1.5/400-3 i550-C2.2/400-3	i550-C3.0/400-3 i550-C4.0/400-3 i550-C5.5/400-3	i550-C7.5/400-3	i550-C11/400-3
Cable installation in compliance with		US National Electrical Code NFPA 70 / Canadian Electrical Code C22.1			
operation		without mains choke			
Fuse					
Characteristics		all acc. to UL 248 / Class CC		all acc. to UL 248 / Class J, T, R	
Max. rated current	A	15	25	40	40
Circuit breaker					
Characteristics		-			
Max. rated current	A	-	25	35	-
operation		with mains choke			
Fuse					
Characteristics		all acc. to UL 248 / Class CC		all acc. to UL 248 / Class J, T, R	
Max. rated current	A	15	25	40	40
Circuit breaker					
Characteristics		-			
Max. rated current	A	-	25	35	-
Earth-leakage circuit breaker					
3-phase mains connection		≥ 30 mA, type B	≥ 300 mA, type B		



## Technical data

3-phase mains connection 480 V  
Fusing and terminal data

<b>Fuse data</b>					
<b>Inverter</b>		<b>i550-C15/400-3 i550-C18/400-3 i550-C22/400-3</b>	<b>i550-C30/400-3</b>	<b>i550-C37/400-3</b>	<b>i550-C45/400-3</b>
Cable installation in compliance with operation		US National Electrical Code NFPA 70 / Canadian Electrical Code C22.1			
Fuse		without mains choke			
Characteristics		all acc. to UL 248 / Class J, T, R			
Max. rated current	A	70	-	-	-
Circuit breaker		with mains choke			
Characteristics		-	-	-	-
Max. rated current	A	-	-	-	-
Fuse		with mains choke			
Characteristics		all acc. to UL 248 / Class J, T, R			
Max. rated current	A	70	80	100	125
Circuit breaker		with mains choke			
Characteristics		-	-	-	-
Max. rated current	A	-	-	-	-
Earth-leakage circuit breaker		with mains choke			
3-phase mains connection		$\geq 300$ mA, type B			

<b>Fuse data</b>					
<b>Inverter</b>		<b>i550-C55/400-3 i550-C75/400-3</b>			
Cable installation in compliance with operation		US National Electrical Code NFPA 70 / Canadian Electrical Code C22.1			
Fuse		without mains choke			
Characteristics		-			
Max. rated current	A	-			
Circuit breaker		with mains choke			
Characteristics		-			
Max. rated current	A	-			
Fuse		with mains choke			
Characteristics		acc. to UL 248 / Class J (recommended: HSJ by Mersen)			
Max. rated current	A	200			
Circuit breaker		with mains choke			
Characteristics		-			
Max. rated current	A	-			
Earth-leakage circuit breaker		with mains choke			
3-phase mains connection		$\geq 300$ mA, type B			

# Technical data

3-phase mains connection 480 V  
Fusing and terminal data



Mains connection					
Inverter		i550-C0.37/400-3 i550-C0.55/400-3 i550-C0.75/400-3 i550-C1.1/400-3 i550-C1.5/400-3 i550-C2.2/400-3	i550-C3.0/400-3 i550-C4.0/400-3 i550-C5.5/400-3	i550-C7.5/400-3 i550-C11/400-3	i550-C15/400-3 i550-C18/400-3 i550-C22/400-3
Connection		X100			
Connection type		pluggable screw terminal	Screw terminal		
Min. cable cross-section	mm <sup>2</sup>	1	1.5		
Max. cable cross-section	mm <sup>2</sup>	2.5	6	16	35
Stripping length	mm	8	9	11	18
Tightening torque	Nm	0.5		1.2	3.8
Required tool		0.5 x 3.0	0.6 x 3.5	0.8 x 4.0	0.8 x 5.5

Mains connection			
Inverter		i550-C30/400-3 i550-C37/400-3 i550-C45/400-3	i550-C55/400-3 i550-C75/400-3
Connection		X100	
Connection type		Screw terminal	
Min. cable cross-section	mm <sup>2</sup>	10	25
Max. cable cross-section	mm <sup>2</sup>	50	95
Stripping length	mm	19	22
Tightening torque	Nm	4	10
Required tool		Allen key 4.0	Allen key 6.0

PE						
Inverter		i550-C0.37/400-3 i550-C0.55/400-3 i550-C0.75/400-3 i550-C1.1/400-3 i550-C1.5/400-3 i550-C2.2/400-3 i550-C3.0/400-3 i550-C4.0/400-3 i550-C5.5/400-3	i550-C7.5/400-3 i550-C11/400-3	i550-C15/400-3 i550-C18/400-3 i550-C22/400-3 i550-C30/400-3 i550-C37/400-3 i550-C45/400-3 i550-C55/400-3 i550-C75/400-3		
Connection		PE				
Connection type		PE screw				
Min. cable cross-section	mm <sup>2</sup>	1.5	2.5	4		
Max. cable cross-section	mm <sup>2</sup>	6	16	25		
Stripping length	mm	10	11	16		
Tightening torque	Nm	2	3.4	4		
Required tool		TORX TX20		PZ2		

Motor connection					
Inverter		i550-C0.37/400-3 i550-C0.55/400-3 i550-C0.75/400-3 i550-C1.1/400-3 i550-C1.5/400-3 i550-C2.2/400-3	i550-C3.0/400-3 i550-C4.0/400-3 i550-C5.5/400-3	i550-C7.5/400-3 i550-C11/400-3	i550-C15/400-3 i550-C18/400-3 i550-C22/400-3
Connection		X105			
Connection type		pluggable screw terminal	Screw terminal		
Min. cable cross-section	mm <sup>2</sup>	1	1.5		
Max. cable cross-section	mm <sup>2</sup>	2.5	6	16	35
Stripping length	mm	8	9	11	18
Tightening torque	Nm	0.5		1.2	3.8
Required tool		0.5 x 3.0	0.6 x 3.5	0.8 x 4.0	0.8 x 5.5





## Technical data

3-phase mains connection 480 V  
Fusing and terminal data

<b>Motor connection</b>			
<b>Inverter</b>		<b>i550-C30/400-3 i550-C37/400-3 i550-C45/400-3</b>	<b>i550-C55/400-3 i550-C75/400-3</b>
Connection		X105	
Connection type		Screw terminal	
Min. cable cross-section	mm <sup>2</sup>	10	25
Max. cable cross-section	mm <sup>2</sup>	50	95
Stripping length	mm	19	22
Tightening torque	Nm	4	10
Required tool		Allen key 4.0	Allen key 6.0

# Technical data

3-phase mains connection 480 V  
Brake resistors



## Brake resistors

Inverter	Brake resistor						
	Order code	Rated resistance	Rated power	Thermal capacity	Dimensions (h x b x t)	Weight	
		Ω	W	kWs	mm	kg	
i550-C0.37/400-3	ERBM390R100W	390	100	15	235 x 21 x 40	0.37	
i550-C0.55/400-3							
i550-C0.75/400-3							
i550-C1.1/400-3	ERBP180R200W	180	200	30	240 x 41 x 122	1	
	ERBP180R300W		300	45	320 x 41 x 122	1.4	
i550-C1.5/400-3	ERBP180R200W		200	30	240 x 41 x 122	1	
	ERBP180R300W		300	45	320 x 41 x 122	1.4	
i550-C2.2/400-3	ERBP180R200W		200	30	240 x 41 x 122	1	
	ERBP180R300W		300	45	320 x 41 x 122	1.4	
i550-C3.0/400-3	ERBP082R200W		82	200	30	320 x 41 x 122	1
	ERBS082R780W			780	117		666 x 124 x 122
i550-C4.0/400-3	ERBP047R200W		47	200	30	320 x 41 x 122	1
	ERBS047R400W			400	60	400 x 110 x 105	2.3
	ERBS047R800W	800		120	710 x 110 x 105	4	
i550-C5.5/400-3	ERBP047R200W	200		30	320 x 41 x 122	1	
	ERBS047R400W	400		60	400 x 110 x 105	2.3	
	ERBS047R800W	800		120	710 x 110 x 105	4	
i550-C7.5/400-3	ERBP027R200W	27		200	30	320 x 41 x 122	1
	ERBS027R600W			600	90	550 x 110 x 105	3.1
	ERBS027R01K2			1200	180	1020 x 110 x 105	5.6
i550-C11/400-3	ERBP027R200W		200	30	320 x 41 x 122	1	
	ERBS027R600W		600	90	550 x 110 x 105	3.1	
	ERBS027R01K2		1200	180	1020 x 110 x 105	5.6	
i550-C15/400-3	ERBS018R800W		18	800	120	710 x 110 x 105	3.9
	ERBS018R01K4			1400	210	1110 x 110 x 105	6.2
	ERBS018R02K8			2800	420	1110 x 200 x 105	12
	ERBG018R04K3	4300		645	486 x 426 x 302	13.5	
i550-C18/400-3	ERBS015R800W	15	800	120	710 x 110 x 105	3.9	
	ERBS015R01K2		1200	180	1020 x 110 x 105	5.6	
	ERBS015R02K4		2400	420	1020 x 200 x 105	10	
	ERBG015R06K2		6200	930	486 x 526 x 302	17	
i550-C22/400-3	ERBS015R800W		800	120	710 x 110 x 105	3.9	
	ERBS015R01K2		1200	180	1020 x 110 x 105	5.6	
	ERBS015R02K4		2400	420	1020 x 200 x 105	10	
	ERBG015R06K2		6200	930	486 x 526 x 302	17	
i550-C30/400-3	ERBG075D01K9	7.5	1900	285	486 x 236 x 302	9.5	
i550-C37/400-3							
i550-C45/400-3							
i550-C55/400-3	ERBG005R02K6	5	2600	390	486 x 326 x 302	11	
i550-C75/400-3							



# Technical data

3-phase mains connection 480 V  
Mains chokes

## Mains chokes

Inverter	Mains choke					
	Order code	Number of phases	Output current	Inductance	Dimensions (h x b x t)	Weight
			A	mH	mm	kg
i550-C0.37/400-3	EZAELN3002B203	3	1.5	19.6	56 x 77 x 100	0.52
i550-C0.55/400-3	EZAELN3002B153		2	14.7		0.53
i550-C0.75/400-3	EZAELN3004B742		4	7.35	60 x 95 x 115	1.31
i550-C1.1/400-3						
i550-C1.5/400-3	EZAELN3006B492		6	4.9	69 x 95 x 120	1.45
i550-C2.2/400-3						
i550-C3.0/400-3	EZAELN3008B372		8	3.68	85 x 120 x 140	1.9
i550-C4.0/400-3						
i550-C5.5/400-3	EZAELN3016B182		16	1.84	95 x 120 x 140	2.7
i550-C7.5/400-3						
i550-C11/400-3	EZAELN3020B152		20	1.47	95 x 155 x 165	3.8
i550-C15/400-3	EZAELN3025B122		25	1.18	110 x 155 x 170	5.8
i550-C18/400-3	EZAELN3030B981		30	0.98		5.85
i550-C22/400-3	EZAELN3040B741		40	0.74	112 x 185 x 200	6.8
i550-C30/400-3	EZAELN3050B591		50	0.59	112 x 185 x 210	8.35
i550-C37/400-3	EZAELN3063B471		63	0.47	122 x 185 x 210	9.65
i550-C45/400-3	EZAELN3080B371		80	0.37	125 x 210 x 240	12.5
i550-C55/400-3	EZAELN3090B331		90	0.33	115 x 267 x 205	11.5
i550-C75/400-3	EZAELN3125B241		125	0.24	139 x 291 x 215	17.5

# Technical data

3-phase mains connection 480 V  
RFI filters / Mains filters



## RFI filters / Mains filters

Basic information on RFI filters, mains filters and EMC: from [163](#)

### Maximum motor cable lengths and FI operation

Mains connection			3-phase, 400 V/480 V			
Inverter			i550-C0.37/400-3	i550-C0.55/400-3 i550-C0.75/400-3	i550-C1.1/400-3 i550-C1.5/400-3 i550-C2.2/400-3	i550-C3.0/400-3 i550-C4.0/400-3 i550-C5.5/400-3
Without RFI filter						
Without EMC category Thermal limitation	Max. motor cable length shielded	m	15	50	50	100
	Max. motor cable length unshielded	m	30	100	200	200
With integrated RFI filter						
Category C1	Max. motor cable length shielded	m	3	3	-	-
Category C2		m	15	20	20	20
	Earth-leakage circuit breaker	mA	30	30	30	300
RFI filter Low Leakage						
Category C1	Max. motor cable length shielded	m	-	-	-	-
	Earth-leakage circuit breaker	mA	-	-	-	-
RFI filter Short Distance						
Category C1	Max. motor cable length shielded	m	15	25	25	25
Category C2		m	15	50	50	50
	Earth-leakage circuit breaker	mA	30	30	30	30
RFI filter Long Distance						
Category C1	Max. motor cable length shielded	m	15	50	50	50
Category C2		m	15	50	50	100
	Earth-leakage circuit breaker	mA	300	300	300	300



## Technical data

3-phase mains connection 480 V  
RFI filters / Mains filters

Mains connection			3-phase, 400 V/480 V			
Inverter			i550-C7.5/400-3 i550-C11/400-3	i550-C15/400-3 i550-C18/400-3 i550-C22/400-3	i550-C30/400-3 i550-C37/400-3 i550-C45/400-3	i550-C55/400-3 i550-C75/400-3
Without RFI filter						
Without EMC category	Max. motor cable length shielded	m	100	100	100	100
Thermal limitation	Max. motor cable length unshielded	m	200	200	200	200
With integrated RFI filter						
Category C1	Max. motor cable length shielded	m	-	-	-	-
Category C2		m	20	20	20	20
	Earth-leakage circuit breaker	mA	300	300	300	300
RFI filter Low Leakage						
Category C1	Max. motor cable length shielded	m	-	-	-	-
	Earth-leakage circuit breaker	mA	-	-	-	-
RFI filter Short Distance						
Category C1	Max. motor cable length shielded	m	25	-	-	-
Category C2		m	50	-	-	-
	Earth-leakage circuit breaker	mA	30	-	-	-
RFI filter Long Distance				<i>from 22 kW: Mains filter</i>		
Category C1	Max. motor cable length shielded	m	50	50	50	50
Category C2		m	100	50	50	50
	Earth-leakage circuit breaker	mA	300	300	300	300

# Technical data

3-phase mains connection 480 V  
RFI filters / Mains filters

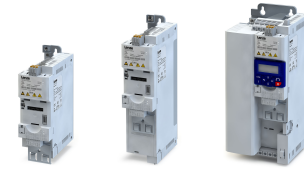

## Short Distance

Inverter	RFI filter			
	Order code	Output current	Dimensions (h x b x t)	Weight
		A	mm	kg
i550-C0.37/400-3	I0FAE175F100S0000S	3.3	276 x 60 x 50	0.9
i550-C0.55/400-3				
i550-C0.75/400-3				
i550-C1.1/400-3	I0FAE222F100S0000S	7.3	346 x 60 x 50	1.1
i550-C1.5/400-3				
i550-C2.2/400-3				
i550-C3.0/400-3	I0FAE255F100S0000S	18	346 x 90 x 60	2.1
i550-C4.0/400-3				
i550-C5.5/400-3				
i550-C7.5/400-3	I0FAE311F100S0000S	29	371 x 120 x 60	2.4
i550-C11/400-3				

## Long Distance

Inverter	RFI filter			
	Order code	Output current	Dimensions (h x b x t)	Weight
		A	mm	kg
i550-C0.37/400-3	I0FAE175F100D0000S	3.3	276 x 60 x 50	0.9
i550-C0.55/400-3				
i550-C0.75/400-3				
i550-C1.1/400-3	I0FAE222F100D0000S	7.3	346 x 60 x 50	1.1
i550-C1.5/400-3				
i550-C2.2/400-3				
i550-C3.0/400-3	I0FAE255F100D0000S	18	346 x 90 x 60	1.7
i550-C4.0/400-3				
i550-C5.5/400-3				
i550-C7.5/400-3	I0FAE311F100D0000S	29	371 x 120 x 60	2
i550-C11/400-3				
i550-C15/400-3	E84AZESR1834LD	50.4	436 x 205 x 90	7.5
i550-C18/400-3				
i550-C22/400-3	E84AZESM2234LD	42	590 x 250 x 105	14
i550-C30/400-3	E84AZESM3034LD	55		23
i550-C37/400-3	E84AZESM3734LD	68		25
i550-C45/400-3	E84AZESM4534LD	80		30

From 22 kW, long distance mains filters are used. Mains filters are a combination of mains choke and RFI filter.



### 3-phase mains connection 480 V "Light Duty"

#### Rated data

The output currents apply to these operating conditions:

- At a switching frequency of 2 kHz or 4 kHz: Ambient temperature above 40 °C with a rated output current reduced by 2.5 %/°C.
- If the load characteristic "Light Duty" and the switching frequencies 8 kHz or 16 kHz are selected, only the values of the load characteristic "Heavy Duty" are reached.

Inverter		i550-C3.0/400-3	i550-C4.0/400-3	i550-C5.5/400-3	i550-C7.5/400-3
<b>Rated power</b>	<b>kW</b>	<b>4</b>	<b>5.5</b>	<b>7.5</b>	<b>11</b>
Mains voltage range		3/PE AC 340 V ... 528 V, 45 Hz ... 65 Hz			
Output voltage		3 AC 0 V ... 480 V			
Rated mains current					
without mains choke	A	8.6	11.2	15.3	22
with mains choke	A	6.8	8.8	12.1	17.2
Apparent output power	kVA	5.9	8	10.5	15
Output current					
2 kHz	A	7.6	9.8	13.2	18.3
4 kHz	A	7.6	9.8	13.2	18.3
Power loss					
4 kHz	W	100	133	173	253
at controller inhibit	W	6	6	6	6
Overcurrent cycle 180 s					
Max. output current	A	9.5	12.3	16.5	21
Overload time	s	60	60	60	60
Recovery time	s	120	120	120	120
Max. output current during the recovery time	A	4.8	6.2	8.3	10.5
Overcurrent cycle 15 s					
Max. output current	A	12.6	16.4	22	28
Overload time	s	3	3	3	3
Recovery time	s	12	12	12	12
Max. output current during the recovery time	A	4.7	6.2	8.3	10.5
Cyclic mains switching		3 times per minute			
Brake chopper					
Max. output current	A	9.5	16.6	16.6	29
Min. brake resistance	Ω	82	47	47	27
Max. motor cable length shielded					
without EMC category	m	50			100
Category C2	m	20			
Weight	kg	2.3			3.7

# Technical data

3-phase mains connection 480 V "Light Duty"

Rated data



Inverter		i550-C11/400-3	i550-C15/400-3	i550-C18/400-3	i550-C22/400-3
<b>Rated power</b>	<b>kW</b>	<b>15</b>	<b>18.5</b>	<b>22</b>	<b>30</b>
Mains voltage range		3/PE AC 340 V ... 528 V, 45 Hz ... 65 Hz			
Output voltage		3 AC 0 V ... 480 V			
Rated mains current					
without mains choke	A	-	40	-	-
with mains choke	A	22.6	30	38	46
Apparent output power	kVA	19	26	32	38
Output current					
2 kHz	A	25.2	32.4	40.8	48.5
4 kHz	A	25.2	32.4	40.8	48.5
Power loss					
4 kHz	W	309	430	533	623
at controller inhibit	W	6	18	18	18
Overcurrent cycle 180 s					
Max. output current	A	31.5	40.5	51	61
Overload time	s	60	60	60	60
Recovery time	s	120	120	120	120
Max. output current during the recovery time	A	15.8	20.3	25.5	30
Overcurrent cycle 15 s					
Max. output current	A	42	54	68	81
Overload time	s	3	3	3	3
Recovery time	s	12	12	12	12
Max. output current during the recovery time	A	15.8	20.3	25.5	30
Cyclic mains switching		3 times per minute			
Brake chopper					
Max. output current	A	29	43	52	52
Min. brake resistance	Ω	27	18	15	15
Max. motor cable length shielded					
without EMC category	m	100			
Category C2	m	20			
Weight	kg	3.7	10.3		





## Technical data

3-phase mains connection 480 V "Light Duty"  
Rated data

Inverter		i550-C30/400-3	i550-C37/400-3	i550-C45/400-3	i550-C55/400-3
<b>Rated power</b>	<b>kW</b>	<b>37</b>	<b>45</b>	<b>55</b>	<b>75</b>
Mains voltage range		3/PE AC 340 V ... 528 V, 45 Hz ... 65 Hz			
Output voltage		3 AC 0 V ... 480 V			
Rated mains current					
without mains choke	A	-	-	-	-
with mains choke	A	59	73	86	105
Apparent output power	kVA	49	61	72	89
Output current					
2 kHz	A	62.4	78	92.4	115
4 kHz	A	62.4	78	92.4	115
Power loss					
4 kHz	W	810	1004	1171	1446
at controller inhibit	W	25	25	25	30
Overcurrent cycle 180 s					
Max. output current	A	78	98	116	144
Overload time	s	60	60	60	60
Recovery time	s	120	120	120	120
Max. output current during the recovery time	A	39	49	58	72
Overcurrent cycle 15 s					
Max. output current	A	104	130	154	192
Overload time	s	3	3	3	3
Recovery time	s	12	12	12	12
Max. output current during the recovery time	A	39	49	58	72
Cyclic mains switching		3 times per minute			1 time per minute
Brake chopper					
Max. output current	A	98	98	98	166
Min. brake resistance	Ω	7.5	7.5	7.5	4.7
Max. motor cable length shielded					
without EMC category	m	100			
Category C2	m	20			
Weight	kg	17.2			24

# Technical data

3-phase mains connection 480 V "Light Duty"

Rated data



Inverter		i550-C75/400-3
<b>Rated power</b>	<b>kW</b>	<b>90</b>
Mains voltage range		3/PE AC 340 V ... 528 V, 45 Hz ... 65 Hz
Output voltage		3 AC 0 V ... 480 V
Rated mains current		
without mains choke	A	-
with mains choke	A	135
Apparent output power	kVA	121
Output current		
2 kHz	A	149
4 kHz	A	149
Power loss		
4 kHz	W	1961
at controller inhibit	W	30
Overcurrent cycle 180 s		
Max. output current	A	186
Overload time	s	60
Recovery time	s	120
Max. output current during the recovery time	A	93
Overcurrent cycle 15 s		
Max. output current	A	248
Overload time	s	3
Recovery time	s	12
Max. output current during the recovery time	A	93
Cyclic mains switching		1 time per minute
Brake chopper		
Max. output current	A	166
Min. brake resistance	Ω	4.7
Max. motor cable length shielded		
without EMC category	m	100
Category C2	m	20
Weight	kg	24



# Technical data

3-phase mains connection 480 V "Light Duty"  
Fusing and terminal data

## Fusing and terminal data

Fuse data					
Inverter		i550-C3.0/400-3 i550-C4.0/400-3 i550-C5.5/400-3	i550-C7.5/400-3	i550-C11/400-3	i550-C15/400-3
Cable installation in compliance with		EN 60204-1			
Installation method		B2			
operation		without mains choke			without mains choke
Fuse					
Characteristics		gG/gL or gRL		-	gG/gL or gRL
Max. rated current	A	25	32	-	63
Circuit breaker					
Characteristics		B		-	B
Max. rated current	A	25	32	-	63
operation		with mains choke			
Fuse					
Characteristics		gG/gL or gRL			
Max. rated current	A	25	32	32	63
Circuit breaker					
Characteristics		B			
Max. rated current	A	25	32	32	63
Earth-leakage circuit breaker					
3-phase mains connection		≥ 300 mA, type B			

Fuse data					
Inverter		i550-C18/400-3 i550-C22/400-3	i550-C30/400-3	i550-C37/400-3	i550-C45/400-3
Cable installation in compliance with		EN 60204-1			
Installation method		B2	C		
operation					
Fuse					
Characteristics		-			
Max. rated current	A	-	-	-	-
Circuit breaker					
Characteristics		-			
Max. rated current	A	-	-	-	-
operation		with mains choke			
Fuse					
Characteristics		gG/gL or gRL			
Max. rated current	A	63	80	100	125
Circuit breaker					
Characteristics		B			
Max. rated current	A	63	80	100	125
Earth-leakage circuit breaker					
3-phase mains connection		≥ 300 mA, type B			

# Technical data

3-phase mains connection 480 V "Light Duty"  
Fusing and terminal data



Fuse data			
Inverter		i550-C55/400-3 i550-C75/400-3	i550-C90/400-3
Cable installation in compliance with		EN 60204-1	
Installation method		F	
operation			
Fuse			
Characteristics		-	
Max. rated current	A	-	-
Circuit breaker			
Characteristics		-	
Max. rated current	A	-	-
operation		with mains choke	
Fuse			
Characteristics		gR	
Max. rated current	A	160	300
Circuit breaker			
Characteristics		-	
Max. rated current	A	-	-
Earth-leakage circuit breaker			
3-phase mains connection		≥ 300 mA, type B	

Fuse data					
Inverter		i550-C3.0/400-3 i550-C4.0/400-3 i550-C5.5/400-3	i550-C7.5/400-3	i550-C11/400-3	i550-C15/400-3
Cable installation in compliance with		US National Electrical Code NFPA 70 / Canadian Electrical Code C22.1			
operation		without mains choke			without mains choke
Fuse					
Characteristics		all acc. to UL 248 / Class CC	all acc. to UL 248 / Class J, T, R	-	all acc. to UL 248 / Class J, T, R
Max. rated current	A	25	40	-	70
Circuit breaker					
Characteristics		-			
Max. rated current	A	25	35	-	-
operation		with mains choke			
Fuse					
Characteristics		all acc. to UL 248 / Class CC	all acc. to UL 248 / Class J, T, R		
Max. rated current	A	25	40	40	70
Circuit breaker					
Characteristics		-			
Max. rated current	A	25	35	-	-
Earth-leakage circuit breaker					
3-phase mains connection		≥ 300 mA, type B			



## Technical data

3-phase mains connection 480 V "Light Duty"  
Fusing and terminal data

Fuse data					
Inverter		i550-C18/400-3 i550-C22/400-3	i550-C30/400-3	i550-C37/400-3	i550-C45/400-3
Cable installation in compliance with operation		US National Electrical Code NFPA 70 / Canadian Electrical Code C22.1			
Fuse					
Characteristics		-			
Max. rated current	A	-	-	-	-
Circuit breaker					
Characteristics		-	-	-	-
Max. rated current	A	-	-	-	-
operation		with mains choke			
Fuse					
Characteristics		all acc. to UL 248 / Class J, T, R			
Max. rated current	A	70	80	100	125
Circuit breaker					
Characteristics		-	-	-	-
Max. rated current	A	-	-	-	-
Earth-leakage circuit breaker					
3-phase mains connection		≥ 300 mA, type B			

Fuse data			
Inverter		i550-C55/400-3 i550-C75/400-3	i550-C90/400-3
Cable installation in compliance with operation		US National Electrical Code NFPA 70 / Canadian Electrical Code C22.1	
Fuse			
Characteristics		-	
Max. rated current	A	-	-
Circuit breaker			
Characteristics		-	-
Max. rated current	A	-	-
operation		with mains choke	
Fuse			
Characteristics		acc. to UL 248 / Class J (recommended: HSJ by Mersen)	all acc. to UL 248 / Class J, T, R
Max. rated current	A	200	300
Circuit breaker			
Characteristics		-	-
Max. rated current	A	-	-
Earth-leakage circuit breaker			
3-phase mains connection		≥ 300 mA, type B	

# Technical data

3-phase mains connection 480 V "Light Duty"  
Fusing and terminal data



Mains connection					
Inverter		i550-C3.0/400-3 i550-C4.0/400-3 i550-C5.5/400-3	i550-C7.5/400-3 i550-C11/400-3	i550-C15/400-3 i550-C18/400-3 i550-C22/400-3	i550-C30/400-3 i550-C37/400-3 i550-C45/400-3
Connection		X100			
Connection type		Screw terminal			
Min. cable cross-section	mm <sup>2</sup>	1.5			10
Max. cable cross-section	mm <sup>2</sup>	6	16	35	50
Stripping length	mm	9	11	18	19
Tightening torque	Nm	0.5	1.2	3.8	4
Required tool		0.6 x 3.5	0.8 x 4.0	0.8 x 5.5	Allen key 4.0

Mains connection			
Inverter		i550-C55/400-3 i550-C75/400-3	i550-C90/400-3
Connection		X100	
Connection type		Screw terminal	
Min. cable cross-section	mm <sup>2</sup>	25	35
Max. cable cross-section	mm <sup>2</sup>	95	150
Stripping length	mm	22	28
Tightening torque	Nm	10	18
Required tool		Allen key 6.0	Allen key 8.0

PE					
Inverter		i550-C3.0/400-3 i550-C4.0/400-3 i550-C5.5/400-3	i550-C7.5/400-3 i550-C11/400-3	i550-C15/400-3 i550-C18/400-3 i550-C22/400-3 i550-C30/400-3 i550-C37/400-3 i550-C45/400-3 i550-C55/400-3 i550-C75/400-3	i550-C90/400-3
Connection		PE			
Connection type		PE screw			PE bolt
Min. cable cross-section	mm <sup>2</sup>	1.5	2.5	4	
Max. cable cross-section	mm <sup>2</sup>	6	16	25	150
Stripping length	mm	10	11	16	-
Tightening torque	Nm	2	3.4	4	10
Required tool		TORX TX20	PZ2		Width across flats 13

Motor connection					
Inverter		i550-C3.0/400-3 i550-C4.0/400-3 i550-C5.5/400-3	i550-C7.5/400-3 i550-C11/400-3	i550-C15/400-3 i550-C18/400-3 i550-C22/400-3	i550-C30/400-3 i550-C37/400-3 i550-C45/400-3
Connection		X105			
Connection type		Screw terminal			
Min. cable cross-section	mm <sup>2</sup>	1.5			10
Max. cable cross-section	mm <sup>2</sup>	6	16	35	50
Stripping length	mm	9	11	18	19
Tightening torque	Nm	0.5	1.2	3.8	4
Required tool		0.6 x 3.5	0.8 x 4.0	0.8 x 5.5	Allen key 4.0



## Technical data

3-phase mains connection 480 V "Light Duty"  
Fusing and terminal data

<b>Motor connection</b>			
<b>Inverter</b>		<b>i550-C55/400-3 i550-C75/400-3</b>	<b>i550-C90/400-3</b>
Connection		X105	
Connection type		Screw terminal	
Min. cable cross-section	mm <sup>2</sup>	25	35
Max. cable cross-section	mm <sup>2</sup>	95	150
Stripping length	mm	22	28
Tightening torque	Nm	10	18
Required tool		Allen key 6.0	Allen key 8.0

# Technical data

3-phase mains connection 480 V "Light Duty"  
Mains chokes



## Brake resistors

Inverter	Brake resistor					
	Order code	Rated resistance	Rated power	Thermal capacity	Dimensions (h x b x t)	Weight
		$\Omega$	W	kWs	mm	kg
i550-C3.0/400-3	ERBP082R200W	82	200	30	320 x 41 x 122	1
	ERBS082R780W		780	117	666 x 124 x 122	3.6
i550-C4.0/400-3	ERBP047R200W	47	200	30	320 x 41 x 122	1
	ERBS047R400W		400	60	400 x 110 x 105	2.3
	ERBS047R800W		800	120	710 x 110 x 105	4
i550-C5.5/400-3	ERBP047R200W	47	200	30	320 x 41 x 122	1
	ERBS047R400W		400	60	400 x 110 x 105	2.3
	ERBS047R800W		800	120	710 x 110 x 105	4
i550-C7.5/400-3	ERBP027R200W	27	200	30	320 x 41 x 122	1
	ERBS027R600W		600	90	550 x 110 x 105	3.1
	ERBS027R01K2		1200	180	1020 x 110 x 105	5.6
i550-C11/400-3	ERBP027R200W	27	200	30	320 x 41 x 122	1
	ERBS027R600W		600	90	550 x 110 x 105	3.1
	ERBS027R01K2		1200	180	1020 x 110 x 105	5.6
i550-C15/400-3	ERBS018R800W	18	800	120	710 x 110 x 105	3.9
	ERBS018R01K4		1400	210	1110 x 110 x 105	6.2
	ERBS018R02K8		2800	420	1110 x 200 x 105	12
	ERBG018R04K3		4300	645	486 x 426 x 302	13.5
i550-C18/400-3	ERBS015R800W	15	800	120	710 x 110 x 105	3.9
	ERBS015R01K2		1200	180	1020 x 110 x 105	5.6
	ERBS015R02K4		2400	420	1020 x 200 x 105	10
	ERBG015R06K2		6200	930	486 x 526 x 302	17
i550-C22/400-3	ERBS015R800W	15	800	120	710 x 110 x 105	3.9
	ERBS015R01K2		1200	180	1020 x 110 x 105	5.6
	ERBS015R02K4		2400	420	1020 x 200 x 105	10
	ERBG015R06K2		6200	930	486 x 526 x 302	17
i550-C30/400-3	ERBG075D01K9	7.5	1900	285	486 x 236 x 302	9.5
i550-C37/400-3						
i550-C45/400-3						
i550-C55/400-3	ERBG005R02K6	5	2600	390	486 x 326 x 302	11
i550-C75/400-3						

## Mains chokes

Inverter	Mains choke					
	Order code	Number of phases	Output current	Inductance	Dimensions (h x b x t)	Weight
			A	mH	mm	kg
i550-C3.0/400-3	EZAELN3008B372	3	8	3.68	85 x 120 x 140	1.9
i550-C4.0/400-3	EZAELN3010B292		10	2.94		2
i550-C5.5/400-3	EZAELN3016B182		16	1.84	95 x 120 x 140	2.7
i550-C7.5/400-3	EZAELN3020B152		20	1.47	95 x 155 x 165	3.8
i550-C11/400-3	EZAELN3025B122		25	1.18	110 x 155 x 170	5.8
i550-C15/400-3	EZAELN3030B981		30	0.98		5.85
i550-C18/400-3	EZAELN3040B741		40	0.74	112 x 185 x 200	6.8
i550-C22/400-3	EZAELN3050B591		50	0.59	112 x 185 x 210	8.35
i550-C30/400-3	EZAELN3063B471		63	0.47	122 x 185 x 210	9.65
i550-C37/400-3	EZAELN3080B371		80	0.37	125 x 210 x 240	12.5
i550-C45/400-3	EZAELN3090B331		90	0.33	115 x 267 x 205	11.5
i550-C55/400-3	EZAELN3125B241		125	0.24	139 x 291 x 215	17.5
i550-C75/400-3	EZAELN3160B191		160	0.19	149 x 291 x 215	22.5





# Technical data

3-phase mains connection 480 V "Light Duty"  
RFI filters / Mains filters

## RFI filters / Mains filters

Basic information on RFI filters, mains filters and EMC: from [163](#)

### Maximum motor cable lengths and FI operation

Mains connection			3-phase, 400 V/480 V, Light Duty			
Inverter			i550-C3.0/400-3 i550-C4.0/400-3 i550-C5.5/400-3	i550-C7.5/400-3 i550-C11/400-3	i550-C15/400-3 i550-C18/400-3 i550-C22/400-3	i550-C30/400-3 i550-C37/400-3 i550-C45/400-3 i550-C55/400-3 i550-C75/400-3
Without RFI filter						
Without EMC category Thermal limitation	Max. motor cable length shielded	m	100	100	100	100
	Max. motor cable length unshielded	m	200	200	200	200
With integrated RFI filter						
Category C1	Max. motor cable length shielded	m	-	-	-	-
Category C2		m	20	20	20	20
	Earth-leakage circuit breaker	mA	300	300	300	300
RFI filter Low Leakage						
Category C1	Max. motor cable length shielded	m	-	-	-	-
	Earth-leakage circuit breaker	mA	-	-	-	-
RFI filter Short Distance						
Category C1	Max. motor cable length shielded	m	25	25	-	-
Category C2		m	50	50	-	-
	Earth-leakage circuit breaker	mA	30	30	-	-
RFI filter Long Distance						
Category C1	Max. motor cable length shielded	m	50	50	-	-
Category C2		m	100	100	-	-
	Earth-leakage circuit breaker	mA	300	300	-	-

### Short Distance

Inverter	RFI filter			
	Order code	Output current	Dimensions (h x b x t)	Weight
		A	mm	kg
i550-C3.0/400-3	I0FAE255F100S0000S	18	346 x 90 x 60	2.1
i550-C4.0/400-3				
i550-C5.5/400-3				
i550-C7.5/400-3	I0FAE311F100S0000S	29	371 x 120 x 60	2.4
i550-C11/400-3				

### Long Distance

Inverter	RFI filter			
	Order code	Output current	Dimensions (h x b x t)	Weight
		A	mm	kg
i550-C3.0/400-3	I0FAE255F100D0000S	18	346 x 90 x 60	1.7
i550-C4.0/400-3				
i550-C5.5/400-3				
i550-C7.5/400-3	I0FAE311F100D0000S	29	371 x 120 x 60	2
i550-C11/400-3				

# Technical data

## Dimensions

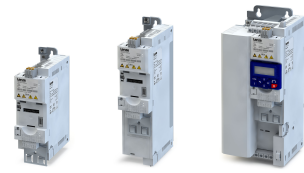

## Dimensions

### 0.25 kW ... 0.37 kW

The dimensions in mm apply to:

0.25 kW	i550-CO.25/230-1	i550-CO.25/230-2	
0.37 kW	i550-CO.37/230-1	i550-CO.37/230-2	i550-CO.37/400-3

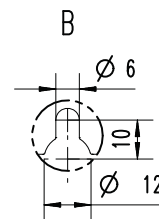
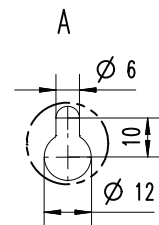
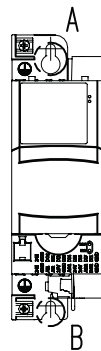
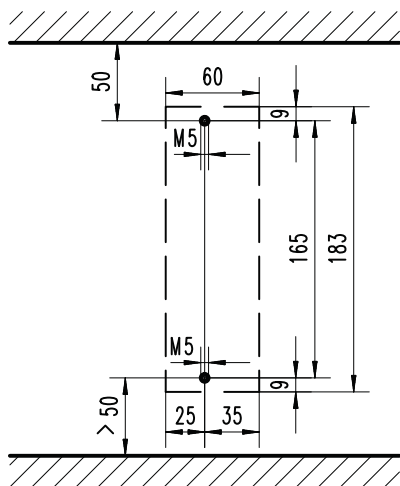
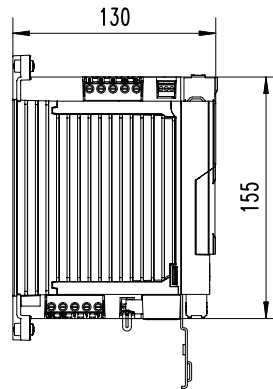
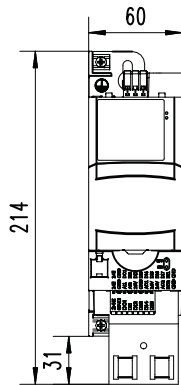

8800263



**0.25 kW ... 0.37 kW**

The dimensions in mm apply to:

0.25 kW	i550-C0.25/120-1
0.37 kW	i550-C0.37/120-1

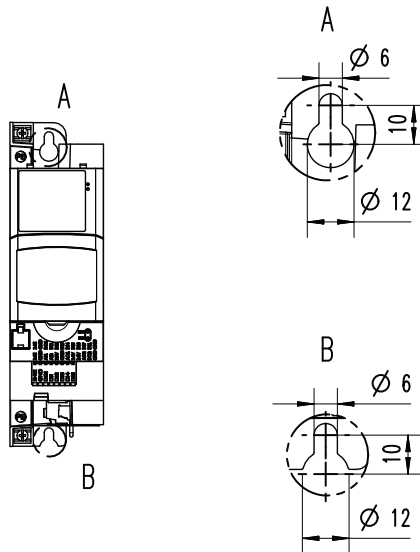
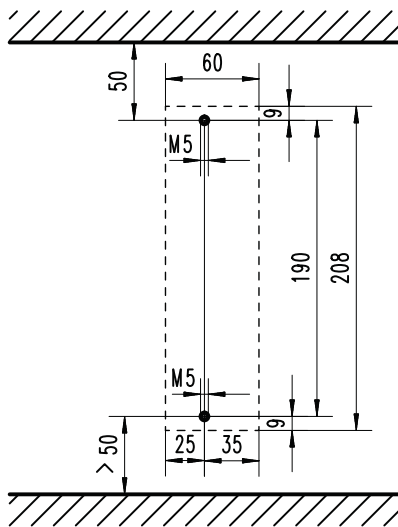
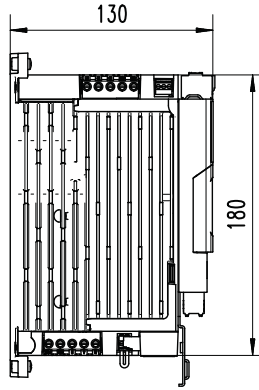
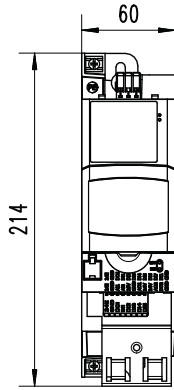

8800264

# Technical data

## Dimensions

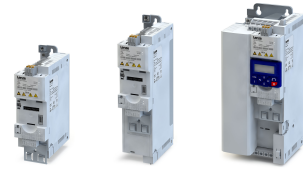

### 0.55 kW ... 0.75 kW

The dimensions in mm apply to:

0.55 kW	i550-CO.55/230-1	i550-CO.55/230-2	i550-CO.55/400-3
0.75 kW	i550-CO.75/230-1	i550-CO.75/230-2	i550-CO.75/400-3

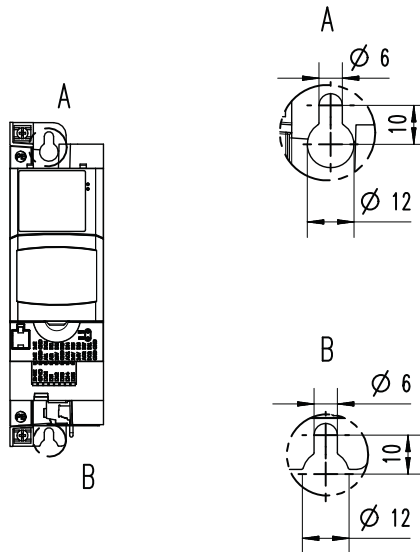
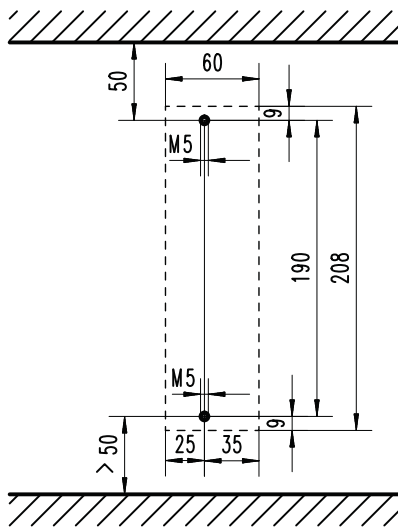
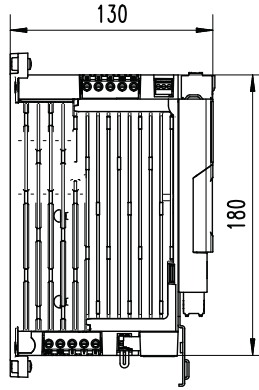
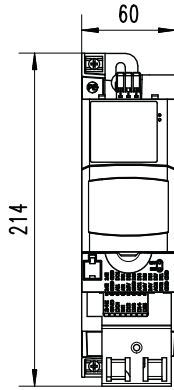

8800264



**0.75 kW ... 1.1 kW**

The dimensions in mm apply to:

0.75 kW	i550-C0.75/120-1
1.1 kW	i550-C1.1/120-1

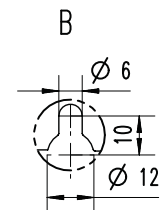
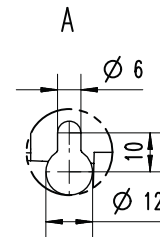
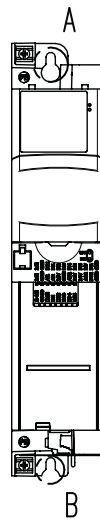
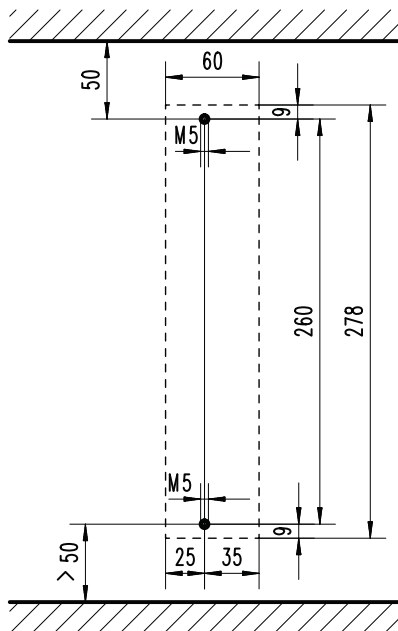
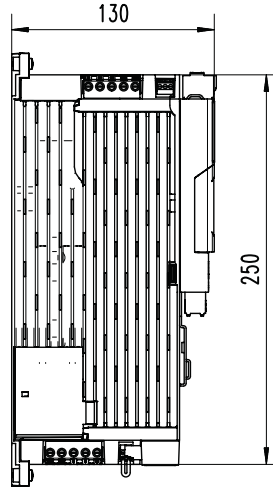
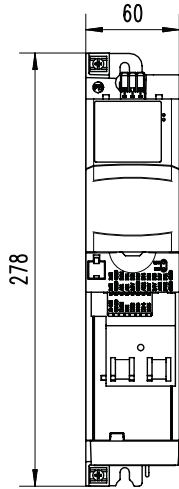

8800265

# Technical data

## Dimensions

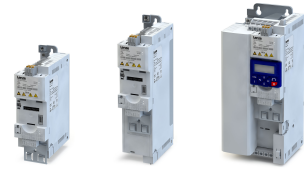

### 1.1 kW ... 2.2 kW

The dimensions in mm apply to:

1.1 kW	i550-C1.1/230-1	i550-C1.1/230-2	i550-C1.1/400-3
1.5 kW	i550-C1.5/230-1	i550-C1.5/230-2	i550-C1.5/400-3
2.2 kW	i550-C2.2/230-1	i550-C2.2/230-2	i550-C2.2/400-3

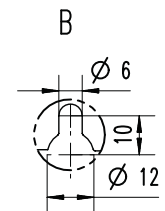
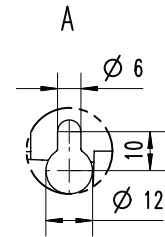
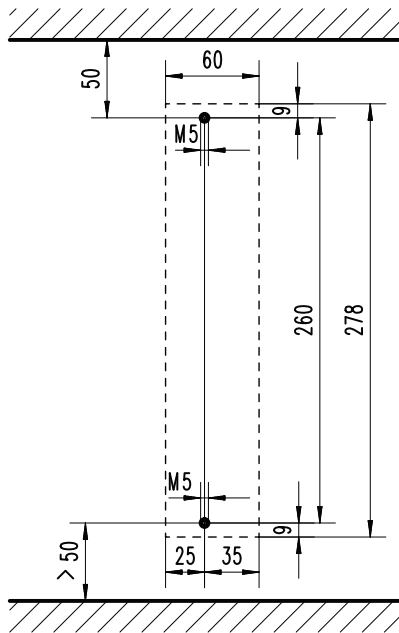
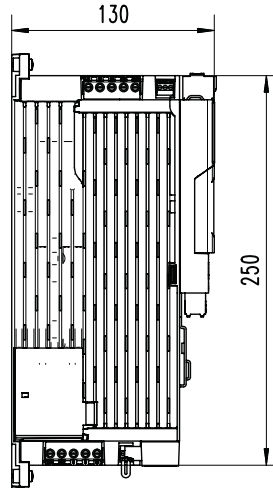
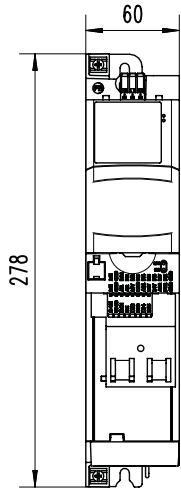

8800265



# Technical data

## Dimensions

### 3 kW ... 5.5 kW

The dimensions in mm apply to:

3 kW		i550-C3.0/400-3
4 kW	i550-C4.0/230-3	i550-C4.0/400-3
5.5 kW	i550-C5.5/230-3	i550-C5.5/400-3

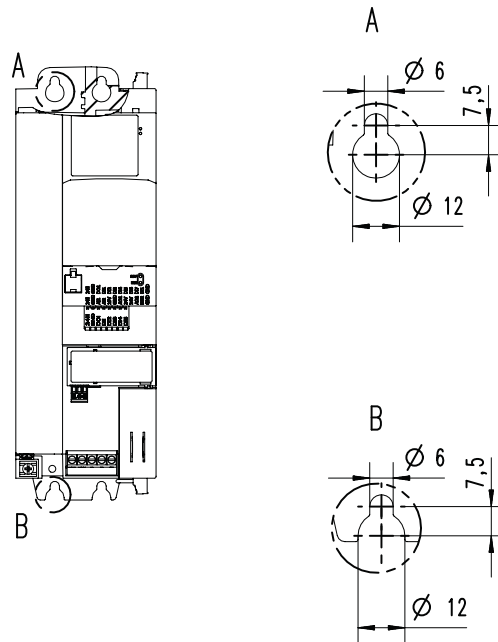
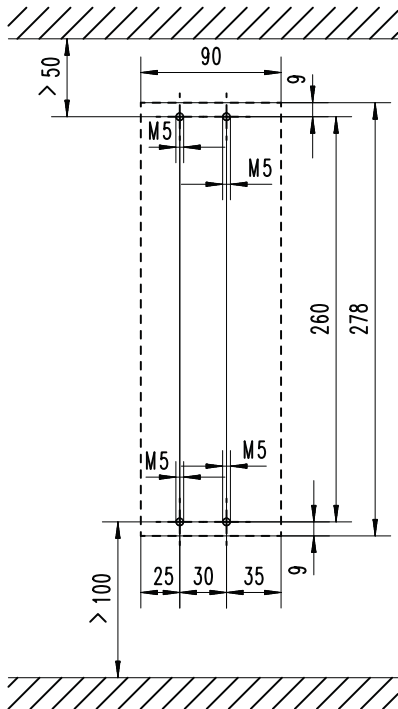
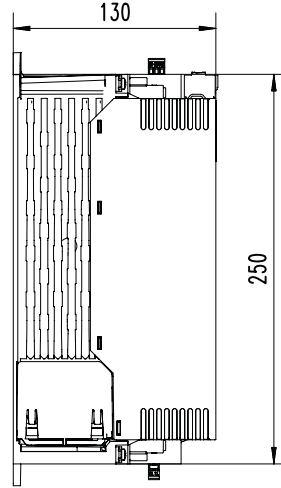
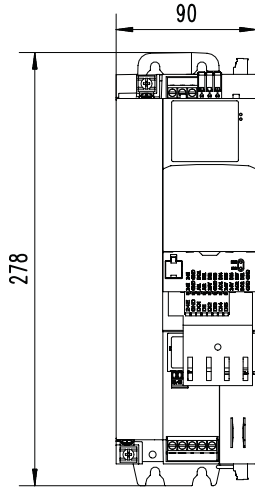

8800288

# Technical data

## Dimensions



### 7.5 kW ... 11 kW

The dimensions in mm apply to:

7.5 kW	i550-C7.5/400-3
11 kW	i550-C11/400-3

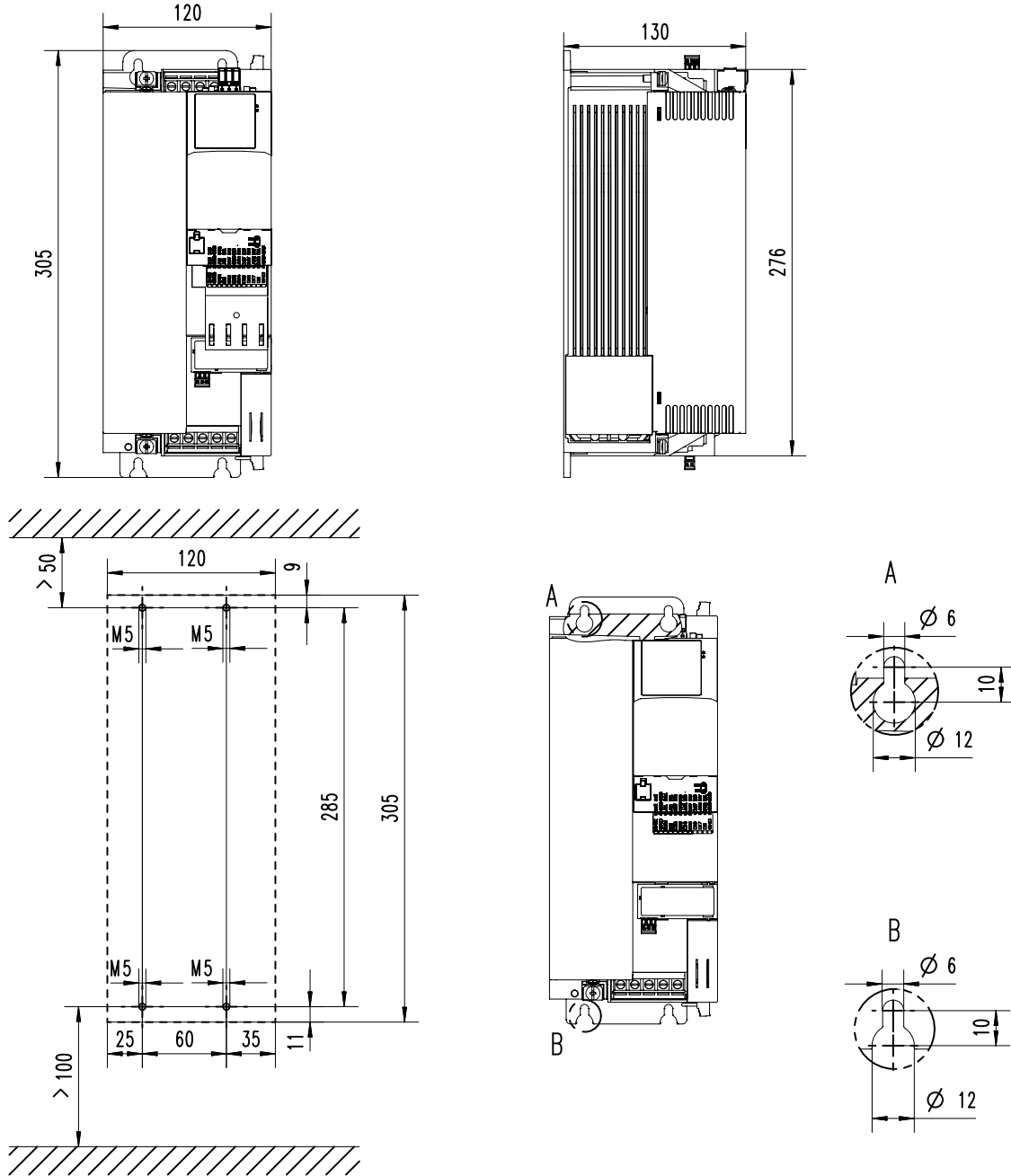

8800296





# Technical data

## Dimensions

### 15 kW ... 22 kW

The dimensions in mm apply to:

15 kW	i550-C15/400-3
18.5 kW	i550-C18/400-3
22 kW	i550-C22/400-3

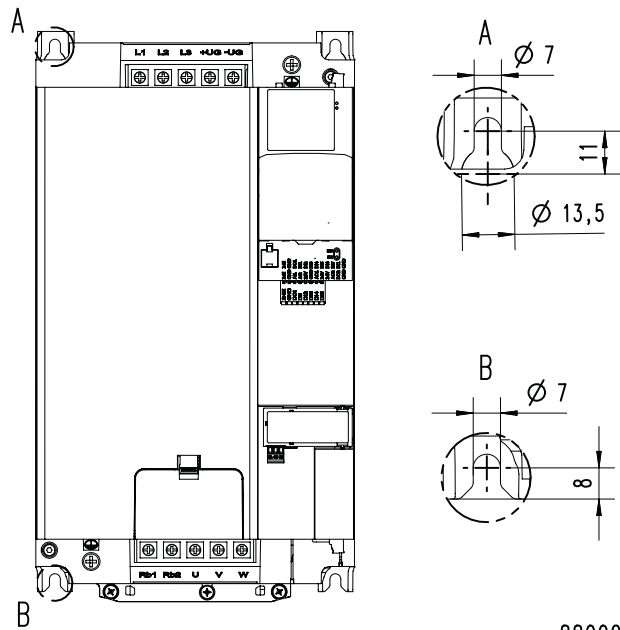
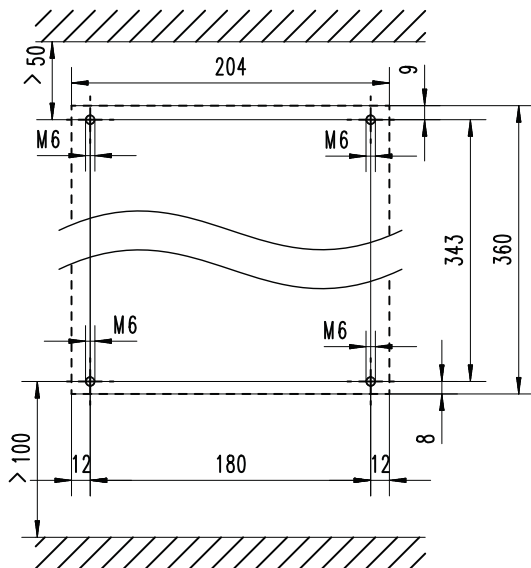
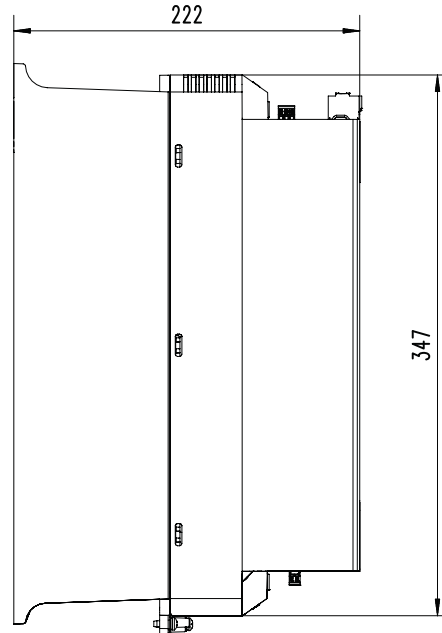
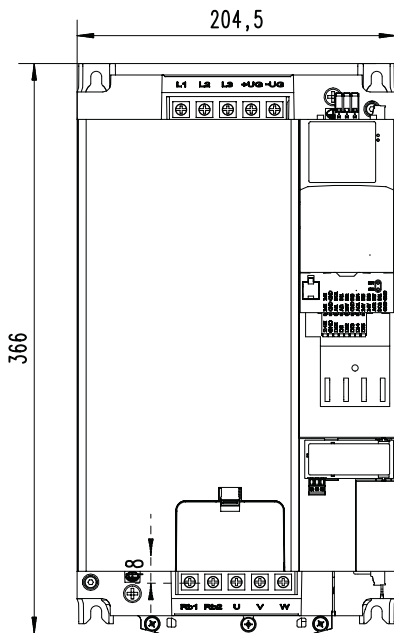

8800297

# Technical data

## Dimensions



### 30 kW ... 45 kW

The dimensions in mm apply to:

30 kW	i550-C30/400-3
37 kW	i550-C37/400-3
45 kW	i550-C45/400-3

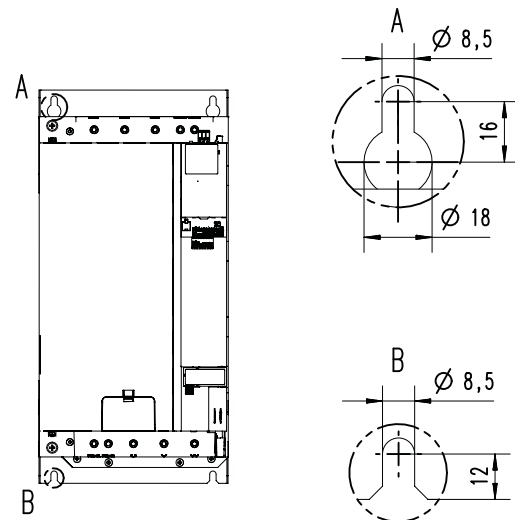
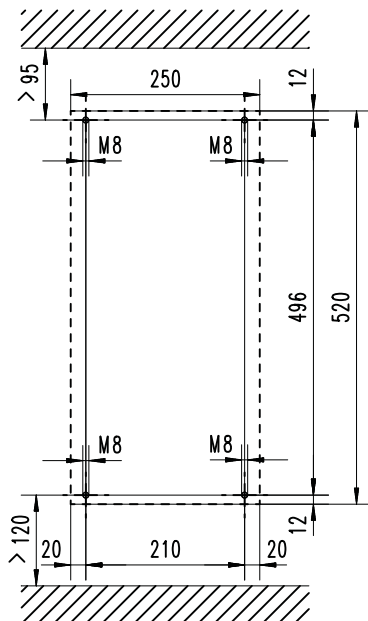
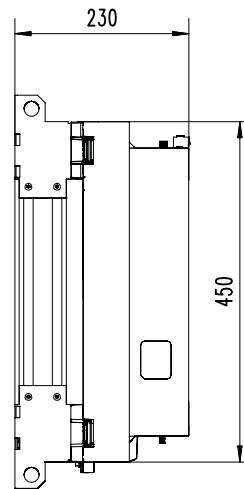
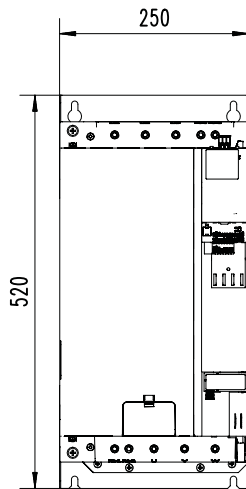

8800313



# Technical data

## Dimensions

### 55 kW ... 75 kW

The dimensions in mm apply to:

55 kW	i550-C55/400-3
75 kW	i550-C75/400-3

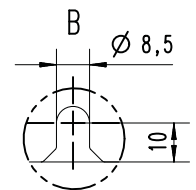
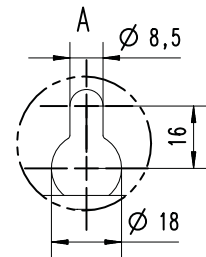
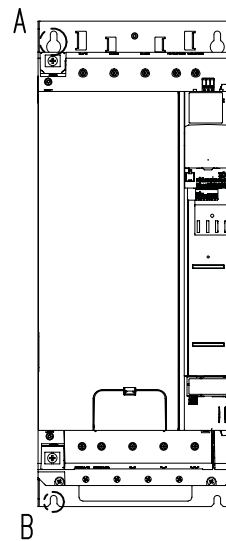
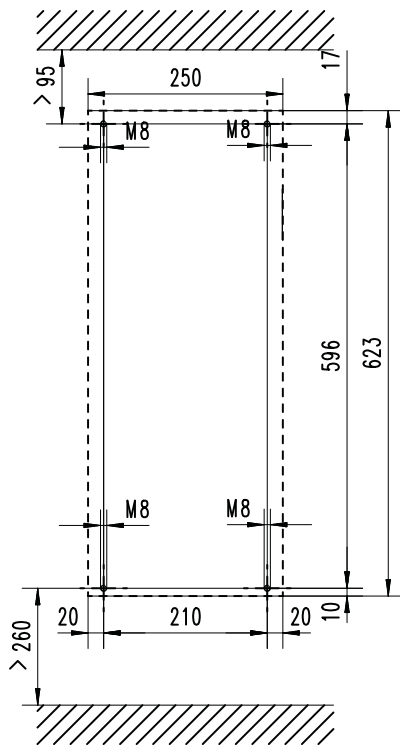
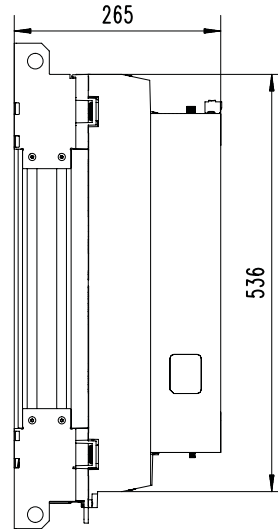
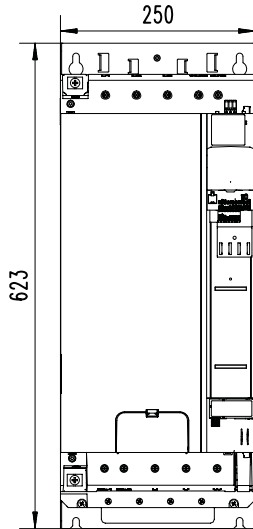

8800315

# Product extensions

Overview



## Product extensions

### Overview

The inverters can be easily integrated into the machine. The scalable product extensions serve to flexibly match the required functions to your application.

The control unit with standard I/O can be extended with different networks.

The control unit with application I/O provides additional inputs and outputs (I/Os). A network component is not available.

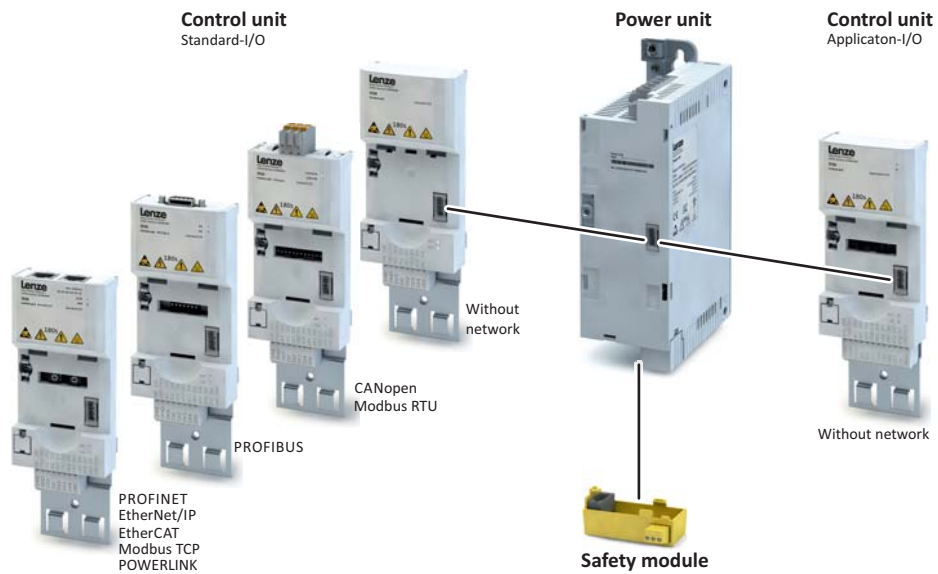



## Product extensions

I/O extensions  
Standard I/O

### I/O extensions

#### Standard I/O

The standard I/O provides the inverter with analog and digital inputs and outputs and is designed for standard applications. The standard I/O is available with different networks.

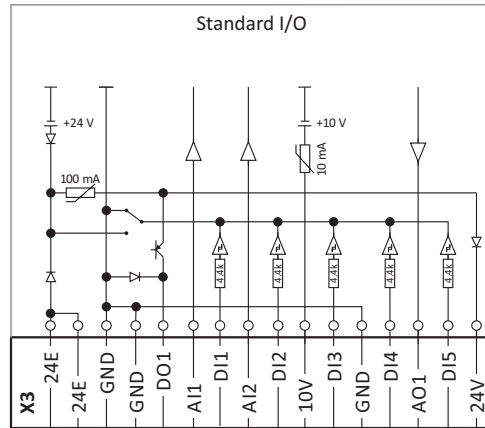

Digital inputs	Terminal X3: DI1, DI2, DI3, DI4, DI5	DI3/DI4 can be optionally used as frequency or encoder input. HIGH active/LOW active switchable
Digital outputs	Terminal X3: DO1	
Analog inputs	Terminal X3: AI1, AI2	can be optionally used as voltage or current input.
Analog outputs	Terminal X3: AO1	Can be optionally used as voltage or current output.
24-V input	Terminal X3: 24E	Mains-independent DC supply of the control electronics (incl. communication)
10-V output	Terminal X3: 10V	Reference voltage or setpoint potentiometer
24-V output	Terminal X3: 24V	
Reference potential	Terminal X3: GND	
Connection system	Pluggable spring terminal	

# Product extensions

I/O extensions  
Application I/O



## Application I/O

In addition to the standard I/O, the application I/O provides the inverter with more digital and analog inputs and is intended for individual applications. The combination with network components is not available.

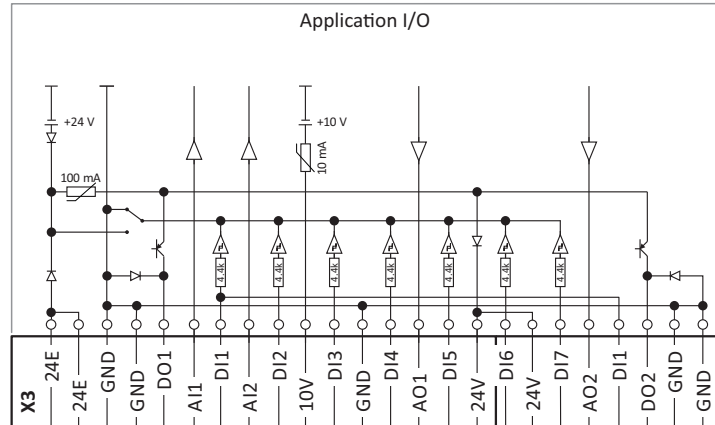

Digital inputs	Terminal X3: DI1, DI2, DI3, DI4, DI5, DI6, DI7	DI3/DI4 can be optionally used as frequency or encoder input. HIGH active/LOW active switchable
Digital outputs	Terminal X3: DO1, DO2	
Analog inputs	Terminal X3: AI1, AI2	can be optionally used as voltage or current input.
Analog outputs	Terminal X3: AO1, AO2	Can be optionally used as voltage or current output.
24-V input	Terminal X3: 24E	Mains-independent DC supply of the control electronics (incl. communication)
10-V output	Terminal X3: 10V	Reference voltage or setpoint potentiometer
24-V output	Terminal X3: 24V	
Reference potential	Terminal X3: GND	
Connection system	pluggable spring terminal	



## Product extensions

I/O extensions  
Data of control connections

### Data of control connections

#### Digital inputs

Switching type		PNP, NPN	Parameterisable
PNP switching level			
LOW	V	< +5	IEC 61131-2, type 1
HIGH	V	> +15	
NPN switching level			
LOW	V	> +15	
HIGH	V	< +5	
Input resistance	kΩ	4.6	
Cycle time	ms	1	can be changed by software filtering
Electric strength of external voltage	V	± 30	

Frequency input			
Connection		X3/DI3, X3/DI4	
Frequency range	kHz	0 ... 100	

Encoder input			
Type		Incremental HTL encoder	
Two-track connection		X3/DI3 X3/DI4	Track A Track B
Frequency range	kHz	0 ... 100	

#### Digital outputs

Switching level			
LOW	V	< +5	IEC 61131-2, type 1
HIGH	V	> +15	
max. output current	mA	100	Total current for DO1 and 24V
Cycle time	ms	1	
Short-circuit strength		Unlimited period	
Electric strength of external voltage	V	± 30	
Polarity reversal protection		Integrated freewheeling diode for switching the inductive load	
Overload behaviour		Reduced voltage or periodic switch-off/on	
Reset or switch-on behaviour		Output is switched off	LOW

# Product extensions

I/O extensions  
Data of control connections



## Analog inputs

Cycle time	ms	1	
Resolution of A/D converter	Bit	12	
Operation as voltage input			
Connection designation		X3/AI1, X3/AI2	
Input voltage DC	V	-10 ... 10	
Input resistance	kΩ	70	
Accuracy	mV	± 50	Typical
Input voltage in case of open circuit	V	- 0.2 ... 0.2	Display "0"
Electric strength of external voltage	V	± 24	
Operation as current input			
Connection designation		X3/AI1, X3/AI2	
Input current	mA	0 ... 20 4 ... 20	open-circuit monitored
Accuracy	mA	± 0.1	Typical
Input current in case of open circuit	mA	< 0.1	Display "0"
Input resistance	Ω	< 250	
Electric strength of external voltage	V	± 24	

## Analog outputs

Short-circuit strength		Unlimited period	
Electric strength of external voltage	V	+ 24V	
Operation as voltage output			
Resolution of D/A converter	Bit	12	
Output voltage DC	V	0 ... 10	
max. output current	mA	5	
min. load resistance	kΩ	≥ 2.2	
Max. capacitive load	μF	1	
Accuracy	mV	± 100	Typical
Operation as current output			
Output current	mA	0 ... 20 4 ... 20	open-circuit monitored
Accuracy	mA	± 0.3	Typical

## 10-V output

Use		Primarily for the supply of a potentiometer (1 ... 10 kΩ)	
Output voltage DC			
Typical	V	10	
Accuracy	mV	± 100	
Max. output current	mA	10	
Max. capacitive load	μF	1	
Short-circuit strength		Unlimited period	
Electric strength of external voltage	V	+ 24	





## Product extensions

I/O extensions  
Data of control connections

### 24-V input

Use		Input for mains-independent DC supply of the control electronics (incl. communication)	
Input voltage DC			
Typical	V	24	IEC 61131-2
Area	V	19.2 ... 28.8	
Input power			
Typical	W	3.6	
Max.	W	6	Depending on the use and state of inputs and outputs.
Input current			
Typical	A	0.150	
Max.	A	1.0	When switching on for 50 ms
Capacity to be charged	µF	440	
Polarity reversal protection		When polarity is reversed: No function and no destruction	
Suppression of voltage pulses		Suppressor diode 30 V, bidirectional	
Power supply unit		SELV/PELV	Externally to create a mains-independent DC supply
Max. current	A	8.0	While looping-through

### 24-V output

Use		Primarily for the supply of digital inputs	
Output voltage DC			
Typical	V	24	
Area	V	16 ... 28	
max. output current	mA	100	Total current for DO... and 24V
Short-circuit strength		Unlimited period	
Electric strength of external voltage	V	+ 30	
Excess current release		Automatically resettable	

# Product extensions

More control connections  
PTC input



## More control connections

### Relay output



Relay is not suitable for direct switching of a electromechanical holding brake!

Use a corresponding suppressor circuit in case of an inductive or capacitive load!

Connection		Terminal X9: COM	Centre contact (common)	
		Terminal X9: NC	Normally-closed contact	
		Terminal X9: NO	Normally-open contact	
Minimum DC contact load				
	Voltage	V	10	A correct switching of the relay contacts needs both values to be exceeded simultaneously.
	Current	mA	10	
Switching voltage/switching current				
Maximum	AC 240 V	A	3	According to UL: General Purpose
	DC 24 V	A	2	According to UL: Resistive
	DC 240 V	A	0.16	

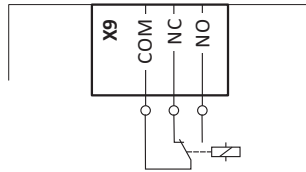

### PTC input



In the Lenze setting, motor temperature monitoring is activated! In the delivery status, there is a wire jumper between the terminals T1 and T2. Before connecting a thermal sensor, remove the wire jumper.

Use	Connection of PTC or thermal contact
Connection	Terminal X109: T1 Terminal X109: T2
Sensor types	PTC single sensor (DIN 44081) PTC triple sensor (DIN 44082) Thermal contact

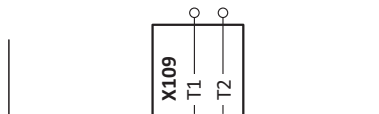

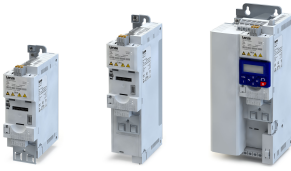

## Networks

### CANopen

CANopen is an internationally approved communication protocol which is designed for commercial and industrial automation applications. High data transfer rates in connection with efficient data formatting provide for the coordination of motion control devices in multi-axis applications.

General information			
Design		Optional Integrated in standard I/O	
DC supply of the control electronics and optional fieldbus		internally via the inverter	Mains-dependent
		optionally: External supply	Mains-independent 24 V DC at X3/24E...GND

Bus-related information			
Name		CANopen CiA 301 V4.2.0	
Communication medium		CAN cable in accordance with ISO 11898-2	
Use		Connection of the inverter to a CANopen network	
Connection system		pluggable double spring terminal	
Status display		2 LEDs	
Connection designation		X216: CH, CL, CG	

Technical data			
Bus terminating resistor	Ω	120	Terminated on both sides
integrated bus terminating resistor		Yes	Activation via DIP switch
Network topology			
without repeater		Line	
with repeater		Line or tree	
Station			
Type		Slave	
Max. number without repeater		127	per bus segment, incl. host system
Address		1 ... 127	Adjustable via code or DIP switch
Baud rate	kbps	20, 50, 125, 250, 500, 800 or 1000	Adjustable via code or DIP switch
Max. bus length	m	2500, 1000, 500, 250, 100, 50 or 25	Total cable length depends on the baud rate
Max. cable length between two nodes		not limited, the max. bus length is decisive	
Process data			
Transmit PDOs		3 TPDOs with 1 ... 8 bytes (adjustable)	
Receive PDOs		3 RPDOs with 1 ... 8 bytes (adjustable)	
Transmission mode for TPDOs			
With change of data		Yes	
Time-controlled, multiple of	ms	10	
After reception		1 ... 240 sync telegrams	
Parameter data			
SDO channels		Max. 2 servers	

Communication time			
Communication time depends on		Processing time in the inverter	Time between the start of a request and arrival of the response
		Telegram runtime (baud rate, telegram length)	
		Nesting depth of the network	
		Bus load	

# Product extensions

Networks  
CANopen



Processing time of process data			
Update cycle, multiple of	ms	10	In the inverter
Processing time	ms	0 ... 1	
application task runtime of the technology application used (tolerance)	ms	1 ... x	

Other data			
Note		There are no interdependencies between parameter data and process data.	

## Typical topologies

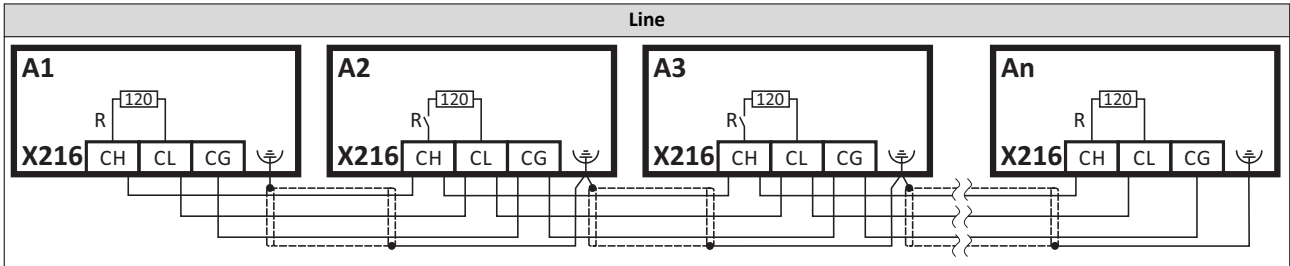

Terminal description		CANopen
Connection		X216
Connection type		pluggable spring terminal
Min. cable cross-section	mm <sup>2</sup>	0.5
Min. cable cross-section	AWG	22
Max. cable cross-section	mm <sup>2</sup>	2.5
Max. cable cross-section	AWG	12
Stripping length	mm	10
Stripping length	inch	0.39
Tightening torque	Nm	-
Tightening torque	lb-in	-
Required tool		0.4 x 2.5



## Modbus RTU

Modbus is an internationally approved, asynchronous, serial communication protocol, designed for commercial and industrial automation applications.

General information			
Design		Optional Integrated in standard I/O	
DC supply of the control electronics and optional fieldbus		internally via the inverter	Mains-dependent
		optionally: External supply	Mains-independent 24 V DC at X3/24E...GND

Bus-related information			
Name		Modbus RTU	
Communication medium		RS485 (EIA)	
Use		Connection of the inverter to a Modbus network	
Connection system		pluggable double spring terminal	
Status display		2 LEDs	
Connection designation		X216: TA, TB, COM	

Technical data			
Communication profile		Modbus RTU	
Bus terminating resistor	Ω	120	Terminated on both sides
integrated bus terminating resistor		Yes	Activation via DIP switch
Network topology			
Without repeater		Line	
Station			
Type		Slave	
Max. number without repeater		32	per bus segment, incl. host system
Max. number with repeater		90	
Address		1 ... 247	Adjustable via code or DIP switch
Baud rate	kbps	4.8 ... 115	Adjustable via code or DIP switch, alternatively automatic detection via DIP switch can be activated
Max. cable length	m	12 ... 600	Per bus segment, depending on the baud rate and the used cable type
Max. cable length between two nodes		not limited, the max. bus length is decisive	
Data channel			
SDO channels		Max. 2 servers, with 1 ... 8 bytes	Supported functions: Read Holding Registers Preset Single Register Preset Multiple Registers Read/Write 4 x registers

Communication time			
Communication time depends on		Processing time in the inverter	Time between the start of a request and arrival of the response
		Telegram runtime (baud rate, telegram length)	
		Nesting depth of the network	
		Bus load	

Processing time of process data			
Update cycle, multiple of	ms	10	In the inverter
Processing time	ms	0 ... 1	
application task runtime of the technology application used (tolerance)	ms	1 ... x	

# Product extensions

Networks  
Modbus RTU

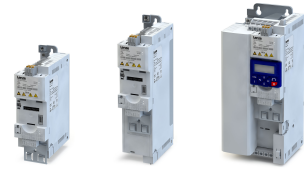

Other data		
Note		There are no interdependencies between parameter data and process data.

## Typical topologies

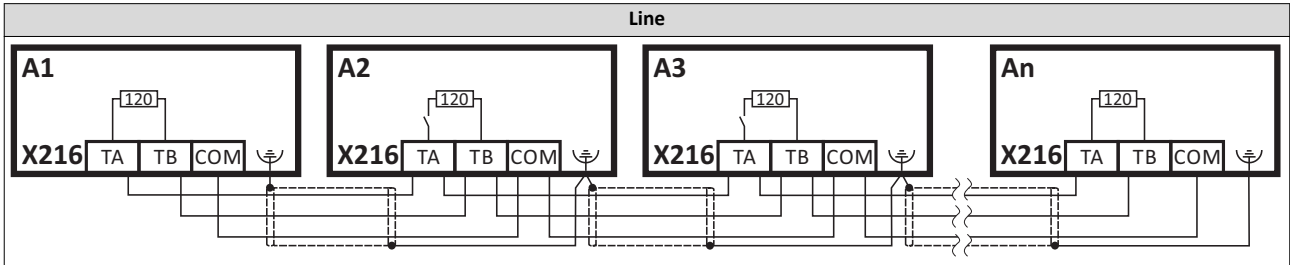

Terminal description		Modbus RTU
Connection		X216
Connection type		pluggable spring terminal
Min. cable cross-section	mm <sup>2</sup>	0.5
Min. cable cross-section	AWG	22
Max. cable cross-section	mm <sup>2</sup>	2.5
Max. cable cross-section	AWG	12
Stripping length	mm	10
Stripping length	inch	0.39
Tightening torque	Nm	-
Tightening torque	lb-in	-
Required tool		0.4 x 2.5



## Modbus TCP

Modbus is an internationally approved Ethernet-based communication protocol, designed for commercial and industrial automation applications.

General information			
Design		Optional Integrated in standard I/O	
DC supply of the control electronics and optional fieldbus		internally via the inverter	Mains-dependent
		optionally: External supply	Mains-independent 24 V DC at X3/24E...GND

Bus-related information			
Name		Modbus TCP	
Communication medium		Ethernet 10 Mbps, 100 Mbps, half duplex, full duplex	
Use		Connection of the inverter to a Modbus TCP network	
Connection system		RJ45	
Status display		2 LEDs	
Connection designation		X276, X277	

Technical data			
Communication profile		Modbus/TCP	
Bus terminating resistor		not required	
integrated bus terminating resistor		No	
Network topology			
Without repeater		Tree, star and line	
With repeater		-	
Station			
Type		Adapter (slave)	
Max. number		254	Per subnetwork
Address		Station name	
Max. cable length	m	-	Not limited The length between the nodes is decisive.
Max. cable length between two nodes	m	100	
Process data			
Transmit PDOs		256 bytes	
Receive PDOs		256 bytes	
Cycle time	ms	> 4	
Switching method		-	
Switch latency	µs	~ 125	At maximum telegram length
Other data		Additional TCP/IP channel	

Communication time			
Communication time depends on		Processing time in the inverter	Time between the start of a request and arrival of the response
		Telegram runtime (baud rate, telegram length)	
		Nesting depth of the network	
		Bus load	

Processing time of process data			
Update cycle, multiple of	ms	10	In the inverter
Processing time	ms	0 ... 1	
application task runtime of the technology application used (tolerance)	ms	1 ... x	

# Product extensions

Networks  
Modbus TCP



Other data	
Note	There are no interdependencies between parameter data and process data.

## Typical topologies

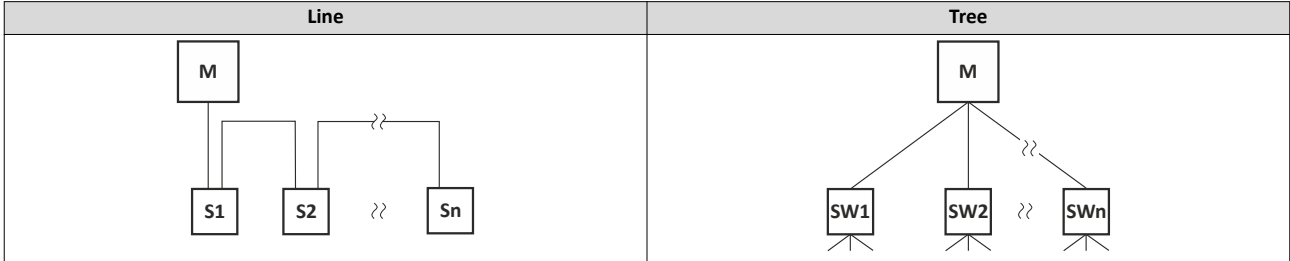

M Master  
S Slave

SW Switch





## PROFIBUS

PROFIBUS is a common fieldbus for the connection of inverters to different control systems in plants.

General information			
Design		Optional Integrated in standard I/O	
DC supply of the control electronics and optional fieldbus		internally via the inverter	Mains-dependent
		optionally: External supply	Mains-independent 24 V DC at X3/24E...GND

Bus-related information			
Name		PROFIBUS-DP	
Communication medium		RS485	
Use		Connection of the inverter to a PROFIBUS-DP network	
Connection system		9-pole Sub-D socket	
Status display		2 LEDs	
Connection designation		X226: Pin 1 ... 9	

Technical data			
Communication profile		PROFIBUS-DP-V0	DRIVECOM parameter data channel
		PROFIBUS-DP-V1	PROFIdrive parameter data channel
Bus terminating resistor	Ω	120	Terminated on both sides
integrated bus terminating resistor		No	
Network topology			
Without repeater		Line	
With repeater		-	
Station			
Type		Slave	
Max. number without repeater		32	per bus segment, incl. host system
Max. number with repeater		125	
Address		1 ... 127	Adjustable via code or DIP switch
Baud rate	kbps	9.6 ... 12000	Automatic detection for cable type A (EN 50170)
Max. bus length	m	1200	Per bus segment, depending on the baud rate and the used cable type
Max. cable length between two nodes		not limited, the max. bus length is decisive	
Process data			
PZD		1 ... 16 words (16 bits/word) in each direction	max. 32 bits (4 bytes) as a coherent PDO object
Transmission mode			
Data length, cyclic		1 ... 16 words, process data channel + 4 words of disconnectable parameter data channel	
Identification number		0x0E550	
User data			
Cyclic (DP-V0)		4 bytes	
Acyclic (DP-V1)		Max. 240 bytes	

Communication time			
Communication time depends on		Processing time in the inverter	Time between the start of a request and arrival of the response
		Telegram runtime (baud rate, telegram length)	
		Nesting depth of the network	
		Bus load	

# Product extensions

Networks  
PROFIBUS



Processing time of process data			
Update cycle, multiple of	ms	10	In the inverter
Processing time	ms	0 ... 1	
application task runtime of the technology application used (tolerance)	ms	1 ... x	

Other data			
Note		There are no interdependencies between parameter data and process data.	

## Typical topologies

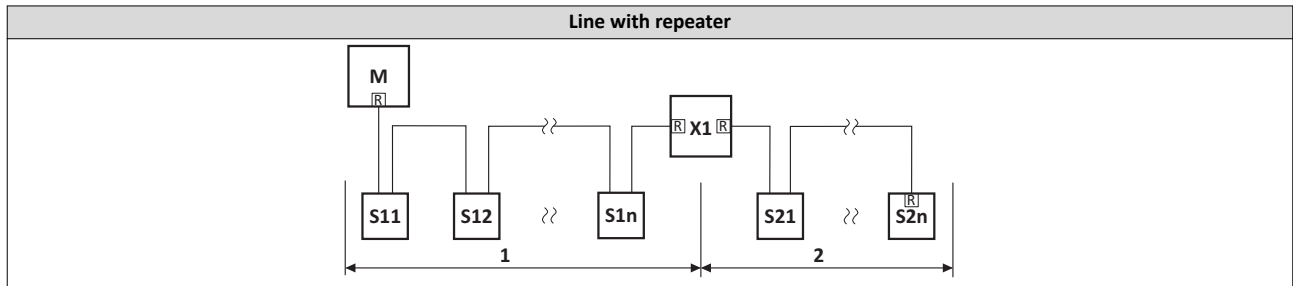

- |   |        |   |                                    |
|---|--------|---|------------------------------------|
| M | Master | X | Repeater                           |
| S | Slave  | R | Activated bus terminating resistor |

## Sub D socket 9-pin - X226

View	Pin	Assignment	Description
	1	Shield	Additional shield connection
	2	n.c.	
	3	RxD/TxD-P	Data line-B (received data/transmitted data +)
	4	RTS	Request To Send (received data/transmitted data, no differential signal)
	5	M5V2	Reference potential (bus terminating resistor -)
	6	P5V2	5 V DC / 30 mA (bus terminating resistor +, OLM, OLP)
	7	n.c.	
	8	RxD/TxD-N	Data line-A (received data/transmitted data -)
	9	n.c.	

Terminal description		PROFIBUS
Connection		X226
Connection type		Sub-D 9p
Min. cable cross-section	mm <sup>2</sup>	-
Min. cable cross-section	AWG	-
Max. cable cross-section	mm <sup>2</sup>	-
Max. cable cross-section	AWG	-
Stripping length	mm	-
Stripping length	inch	-
Tightening torque	Nm	-
Tightening torque	lb-in	-
Required tool		-



## EtherCAT

EtherCAT is a common fieldbus for the connection of inverters to different control systems in plants.

### Typical topologies

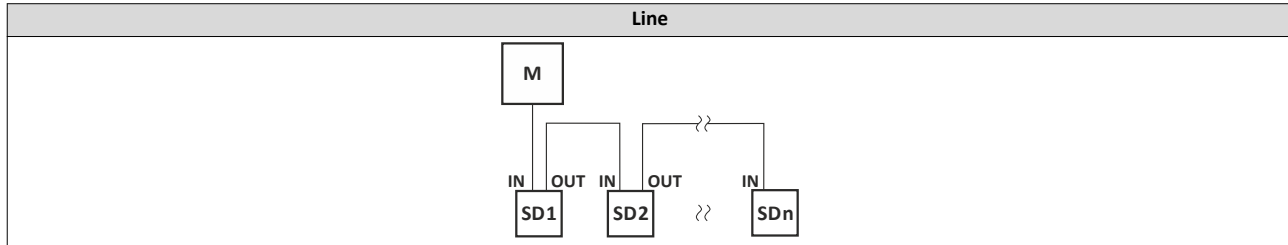

M Master  
SD Slave Device

General information			
Design		Optional Integrated in standard I/O	
DC supply of the control electronics and optional fieldbus		internally via the inverter	Mains-dependent
		optionally: External supply	Mains-independent 24 V DC at X3/24E...GND

Bus-related information			
Name		EtherCAT	
Communication medium		Ethernet 100 Mbps, full duplex	
Use		Connection of the inverter to an EtherCAT network	
Connection system		RJ45	
Status display		2 LEDs	
Connection designation		In: X246 Out: X247	

Technical data			
Communication profile		EtherCAT	
		CANopen over EtherCAT (CoE)	
Bus terminating resistor	Ω	not required	
integrated bus terminating resistor		No	
Network topology			
Without repeater		Line, switch	
With repeater		-	
Station			
Type		EtherCAT slave	
Max. number		65535	In the entire network
Address			Adjustable via parameter
Max. cable length	m	-	Not limited The length between the nodes is decisive.
Max. cable length between two nodes	m	100	
Process data			
Transmit PDOs		16 words	max. 32 bits (4 bytes) as a coherent PDO object
Receive PDOs		16 words	
Cycle times	ms	integer multiple of 1	

# Product extensions

Networks  
EtherCAT



Communication time			
Communication time depends on		Processing time in the inverter	Time between the start of a request and arrival of the response
		Telegram runtime (baud rate, telegram length)	
		Nesting depth of the network	
		Bus load	
Processing time of process data			
Update cycle, multiple of	ms	10	In the inverter
Processing time	ms	0 ... 1	
application task runtime of the technology application used (tolerance)	ms	1 ... x	
Other data			
Note		There are no interdependencies between parameter data and process data.	



## EtherNet/IP

EtherNET/IP is a common fieldbus for the connection of inverters to different control systems in plants.

General information			
Design		Optional Integrated in standard I/O	
DC supply of the control electronics and optional fieldbus		internally via the inverter	Mains-dependent
		optionally: External supply	Mains-independent 24 V DC at X3/24E...GND

Bus-related information			
Name		EtherNet/IP	
Communication medium		Ethernet 10 Mbps, 100 Mbps, half duplex, full duplex	
Use		Connection of the inverter to an Ether-Net/IP network	
Connection system		RJ45	
Status display		2 LEDs	
Connection designation		X266, X267	

Technical data			
Communication profile		EtherNet/IP	
		AC Drive	
Bus terminating resistor		not required	
integrated bus terminating resistor		No	
Network topology			
Without repeater		Tree, star and line	
With repeater		-	
Station			
Type		Adapter (slave)	
Max. number		254	Per subnetwork
Address		Station name	
Max. cable length	m	-	Not limited The length between the nodes is decisive.
Max. cable length between two nodes	m	100	
Process data			
Transmit PDOs		16 words	max. 32 bits (4 bytes) as a coherent PDO object
Receive PDOs		16 words	
Cycle time	ms	> 4	
Switching method		Store-and-Forward Cut-Through	
Switch latency	µs	~ 125	At maximum telegram length
Other data		Additional TCP/IP channel	

Communication time			
Communication time depends on		Processing time in the inverter	Time between the start of a request and arrival of the response
		Telegram runtime (baud rate, telegram length)	
		Nesting depth of the network	
		Bus load	

Processing time of process data			
Update cycle, multiple of	ms	10	In the inverter
Processing time	ms	0 ... 1	
application task runtime of the technology application used (tolerance)	ms	1 ... x	

# Product extensions

Networks  
EtherNet/IP



Other data	
Note	There are no interdependencies between parameter data and process data.

## Typical topologies

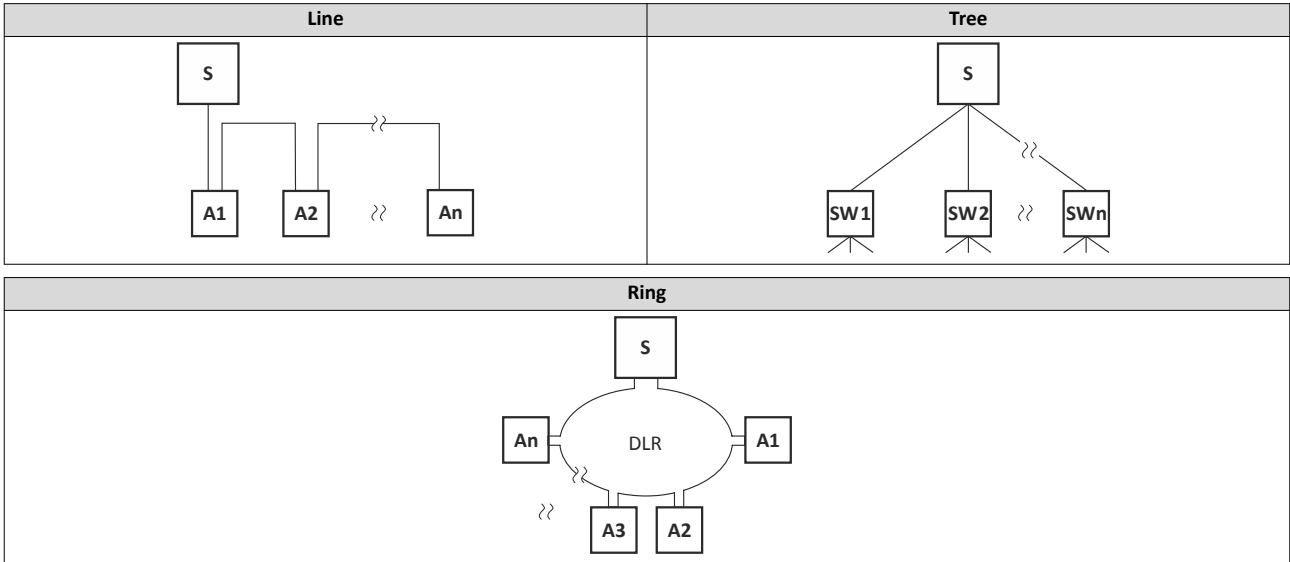

S Scanner  
A Adapter

SW Switch



**PROFINET**

PROFINET is a common fieldbus for the connection of inverters to different control systems in plants.

**Typical topologies**

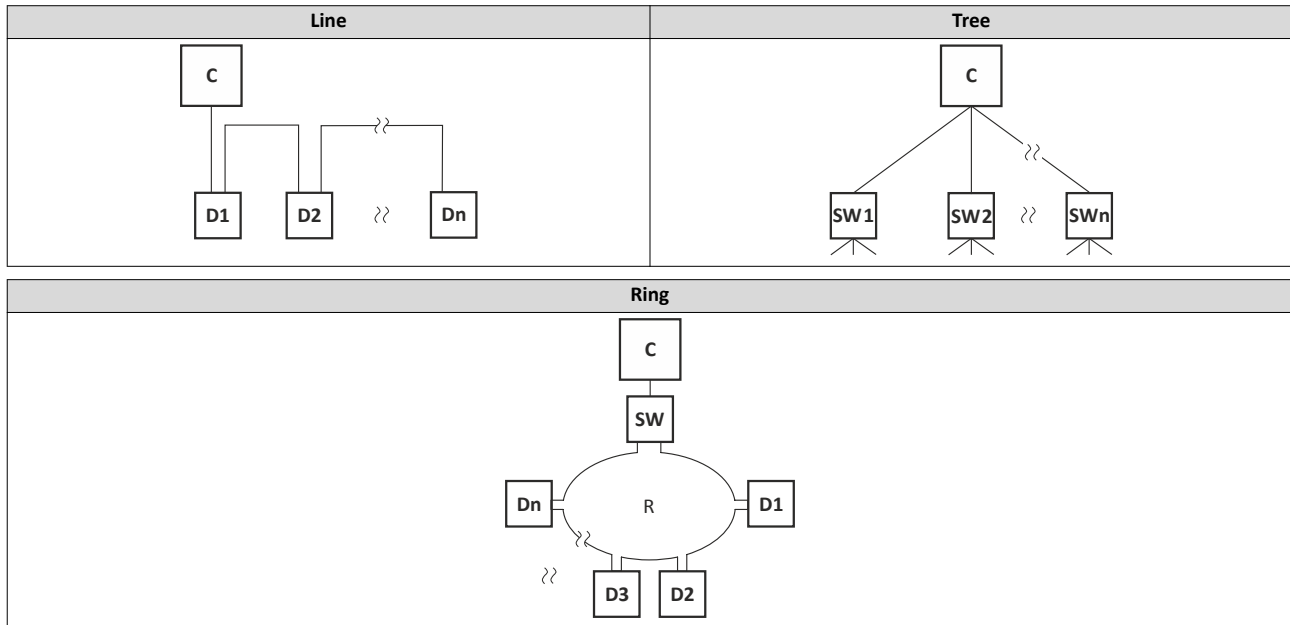

C	IO controller	SW	Switch SCALANCE (MRP capable)
D	IO device	R	Redundant domain

General information			
Design		Optional Integrated in standard I/O	
DC supply of the control electronics and optional fieldbus		internally via the inverter	Mains-dependent
		optionally: External supply	Mains-independent 24 V DC at X3/24E...GND

Bus-related information			
Name		PROFINET RT	
Communication medium		Ethernet 100 Mbps, full duplex	
Use		Connection of the inverter to a PROFINET network	
Connection system		RJ45	
Status display		2 LEDs	
Connection designation		X256, X257	

# Product extensions

Networks  
PROFINET



Technical data			
Communication profile		PROFINET RT	
Bus terminating resistor		not required	
integrated bus terminating resistor		No	
Network topology			
Without repeater		Tree, star and line	
With repeater		-	
Station			
Type		I/O device with real time (RT) communication properties	
Max. number		255	Per subnetwork
Address		Station name	
Max. cable length	m	-	Not limited The length between the nodes is decisive.
Max. cable length between two nodes	m	100	
Process data			
Transmit PDOs		16 words	max. 32 bits (4 bytes) as a coherent PDO object
Receive PDOs		16 words	
Cycle time	ms	2,4,8,16	
Switching method		Store-and-Forward	
Switch latency	µs	~ 125	At maximum telegram length
Other data		Additional TCP/IP channel	





**POWERLINK**

Ethernet POWERLINK is a common fieldbus for the connection of inverters to different control systems in plants.

**Typical topologies**

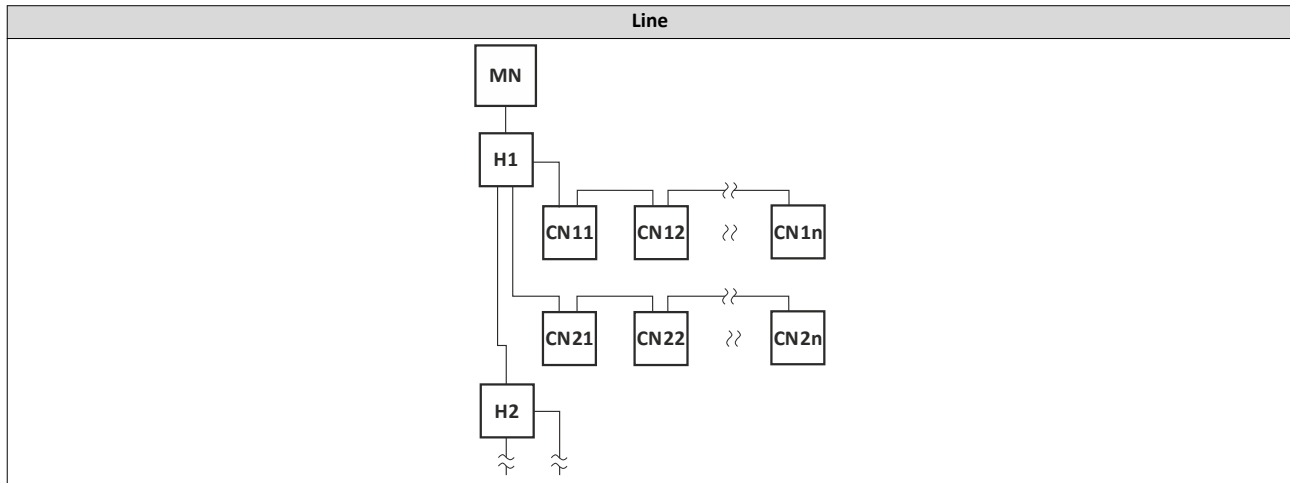

Mnated Managing Node  
CN Controlled Node

H Hub

General information			
Design		Optional Integrated in standard I/O	
DC supply of the control electronics and optional fieldbus		internally via the inverter	Mains-dependent
		optionally: External supply	Mains-independent 24 V DC at X3/24E...GND

Bus-related information			
Name		Ethernet POWERLINK	
Communication medium		Ethernet 100 Mbps, half duplex	
Used for...		Connection to the inverter to a POWER-LINK network	
Connection system		RJ45	
Status display		2 LEDs	
Connection designation		X286, X287	

# Product extensions

Networks  
POWERLINK



Technical data			
Communication profile		POWERLINK	
		AC Drive	
Bus terminating resistor		not required	
integrated bus terminating resistor		No	
Network topology			
Without repeater		Tree, star and line	
With repeater		-	
Station			
Type		Adapter (controlled node, CN)	
Max. number		240	
Address		Station name	
Max. cable length	m	-	Not limited The length between the nodes is decisive.
Max. cable length between two nodes	m	100	
Process data			
Transmit PDOs		4 words	max. 16 bits (2 bytes) as a coherent PDO object
Receive PDOs		2 words	
Cycle time	ms	Multiple of 0.4 ms and 0.5 ms	
Other data		Additional TCP/IP channel	

Communication time			
Communication time depends on		Processing time in the inverter	Time between the start of a request and arrival of the response
		Telegram runtime (baud rate, telegram length)	
		Nesting depth of the network	
		Bus load	

Processing time of process data			
Update cycle, multiple of	ms	10	In the inverter
Processing time	ms	0 ... 1	
application task runtime of the technology application used (tolerance)	ms	1 ... x	

Other data			
Note		There are no interdependencies between parameter data and process data.	



## Functional safety

### Safety module

Integrated safety provides the conditions to optimise the safety functions. In comparison to the use of standard safety engineering, integrated safety increases machine functionality and availability. Planning and installation expenditure is reduced.

The integrated safety system can be used for the protection of persons working on machines in accordance with the Machinery Directive.

The safety module serves to use the "safe torque off" (STO) safety function.

The motion functions are continued to be executed by the inverter. The integrated safety system monitors the safe compliance with the limit values and provides the safe inputs. If monitored limit values are exceeded, the integrated safety system starts control functions in the inverter according to EN 60204-1 to counteract possible errors.



Detailed information can be obtained from the "Functional safety" planning manual.

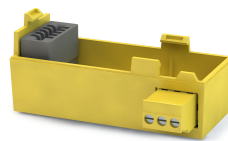

Safety module	
Order code	Version
I5MASAV000000S	STO (Safe torque off)

# Accessories

Overview



## Accessories

### Overview

A package of accessories optimally matched to the inverter is available for your applications.

Moreover, the pluggable modules make commissioning and diagnostics easier.

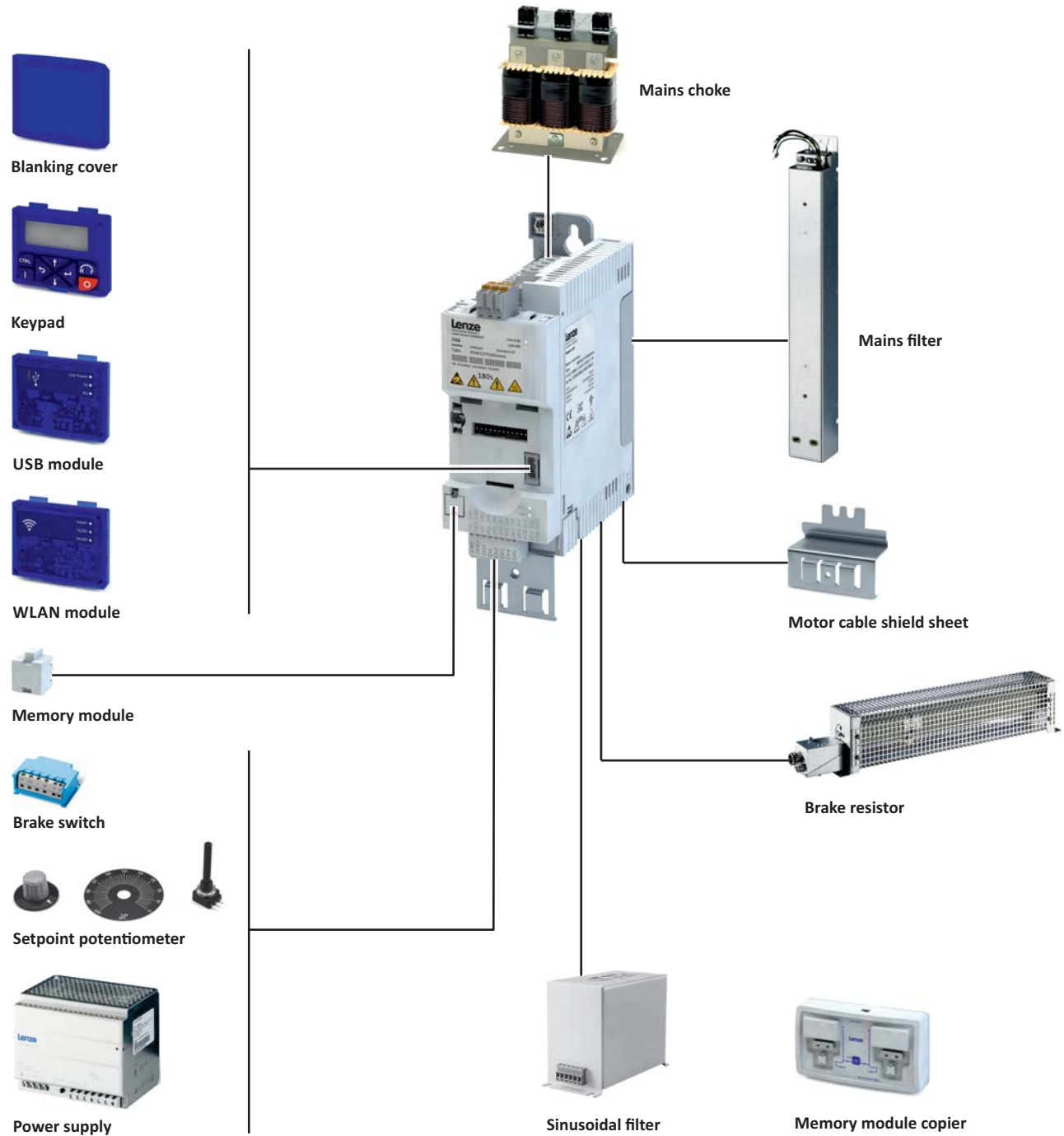

Further accessories: terminal strips and latching terminals for the shield sheet of the control unit.



## Operation and diagnostics

### Keypad

Parameter setting and diagnostics

Thanks to the intuitive operating structure, the navigation keys allow a quick and easy access to the most important parameters, either to configure functions or to query current values. Parameters and actual values are indicated on the easy-to-read display.



Keypad	
Order code	Design
I5MADK0000000S	16-digit LED display Display in German/English

### USB module

Interface to the PC

The USB 2.0-connecting cable is used to connect the inverter with a PC with the »EASY Starter« Lenze Engineering Tool. The »EASY Starter« serves to configure the inverter via graphical interfaces. They create diagnostics with trend functions or monitor parameter values.

Parameterising without supplying the inverter with voltage: If you connect the inverter directly to the PC without a hub, in many cases the USB interface of the PC is sufficient for the voltage supply.



Inverters with network option EtherCAT, PROFINET or EtherNET/IP must be supplied with an additional voltage for setting parameters if a connection cable longer than 3 m is used.

Please observe the following for USB modules labelled as "PRE-SERIES": Inverters with network option EtherCAT, PROFINET or EtherNET/IP must always be supplied with an additional voltage for setting parameters.

USB module	
Order code	Type
I5MADU0000000S	Parameter setting without voltage supply of the inverter is possible. USB 2.0 connecting cable required

Connecting cable		
Order code	Length	Version
EWL0085/S	3 m	USB 2.0-connecting cable (A plug to micro-B plug)
EWL0086/S	5 m	

# Accessories

Operation and diagnostics  
WLAN module



## WLAN module

The wireless interface

Wireless communication with the inverter.

- via a PC with the Lenze «EASY Starter» Engineering Tool or
- via the Lenze Smart keypad app for Android smartphones.

The app is recommended for adapting easy applications. The clearly arranged user interface of the app guides you intuitively and safely through all the menus. Operation corresponds to keypad operation.



### **WARNING!**

- ▶ This product contains FCC ID: QQQWF121/IC: 5123A-BGTWF121
- ▶ To comply with FCC and Industry Canada RF radiation exposure limits for general population, the transmitter with its antenna must be installed such that a minimum separation distance of 20 cm is maintained between the radiator (antenna) and all persons at all times.
- ▶ This product must not be collocated or operated in conjunction with any other antenna or transmitter.
- ▶ -----
- ▶ Le produit contient un module transmetteur certifié FCC ID: QQQWF121/IC: 5123A-BGTWF121
- ▶ Afin de se conformer aux réglementations de la FCC et d'Industry Canada relatives aux limites d'exposition aux rayonnements RF pour le grand public, le transmetteur et son antenne doivent être installés de sorte qu'une distance minimale de 20 cm soit constamment maintenue entre le radiateur (antenne) et toute personne.
- ▶ Le produit ne doit pas être utilisé en combinaison avec d'autres antennes ou transmetteurs.



The use of this module may be restricted or prohibited due to country-specific provisions or additionally required certifications.

The module has been certified according to:

- CE
- FCC
- IC
- CMIIT

The module can be used if the certification is recognised in one country according to one of these standards.



LED status displays			
LED 1	LED 2	LED 3	Meaning
Power (green)	TX/RX (yellow)	WLAN (green)	
Supply voltage status	Communication status	WLAN status	
OFF	OFF	OFF	No voltage
ON	ON	ON	Self-test (approx. 1 s)
ON	OFF	OFF	Ready for operation No active WLAN connection
ON	Flashing	ON	Communication active
ON	OFF	Blinking	Client Mode Waiting for connection
Blinking	OFF	OFF	Trouble

The Lenze Smart keypad app can be found in the Google Play Store.



Additional conformities and approvals		
CE	R&TTE/RED	EN 301489-1 V1.9.2:2011
		EN 301489-17 V2.2.1:2012
		EN 300328 V1.8.1:2012-06
FCC	Part 15.107/15.109 ICES-003	

Connection data (default setting)	
IP address	192.168.178.1
SSID	<Product type>_<10-digit identifier>
Password	password

WLAN module	
Order code	Design
I5MADW0000000S	Range in open space: 100 m, conditions on site may restrict the range.

# Accessories

## Memory modules



### Blanking cover

Protection and optics

The blanking cover protects the terminals and provides for uniform optics if no other module is plugged on.



Blanking cover		
Order code	Version	VPE
		Piece
I5ZAA0000M	Protection against dust Uniform optics	4

### Setpoint potentiometer

For the external selection of an analog setpoint.

The setpoint selection (e.g. motor speed) can be manually set via the external potentiometer.

The setpoint potentiometer is connected to the analog input terminals of the inverter.

The position is displayed on the scale via the rotary knob.

The components have to be ordered separately.



Setpoint potentiometer		
Order code	Name	Version
ERPD0010K0001W	Potentiometer	10 kΩ/1 W
ERZ0001	Rotary knob	Diameter 36 mm
ERZ0002	Scale	Scale 0 ... 100 %, Diameter 62 mm

### Memory modules

For standard set-up, Lenze offers its customers multipacked, unwritten memory modules (EPM). Together with the EPM copier, the EPMs can be duplicated at any place.

A memory module is included in the scope of supply of the inverter.



Memory module		
Order code	Version	VPE
		Piece
I0MAPA0000000M	Easily pluggable Duplicate data set with memory module copier	12





## Memory module copier

For duplicating data on memory modules for a faster standard set-up.

The memory module copier is a copying system for all memory modules from Lenze. With the help of simple optical user guidance, the data of a module is copied quickly and reliably to another memory module.



Memory module copier	
Order code	Version
EZAEDE1001	Data set copier for memory modules

## Brake resistors

To decelerate greater moments of inertia or with a longer operation in generator mode an external brake resistor is required.

While the speed value is reduced by the inverter, the motor operates as generator and supplies energy to the inverter. The brake resistor absorbs the produced brake energy and converts it into heat.

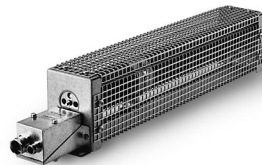

The adapted assignment of these accessories and the technical data are provided with the devices.

# Accessories

## Mains chokes



---

### Mains chokes

Mains chokes reduce the effects of the inverter on the supplying mains.

The switching operations in the inverter cause high-frequency interferences that will be transmitted unfiltered to the supplying mains. Mains chokes smooth the steep and pulse-like curves coming from the Inverter and make them more sinusoidal. Moreover, the effective mains current is reduced and thus energy is saved.

Mains chokes can be used without restrictions in conjunction with RFI filters.

Please note that the use of a mains choke reduces the mains voltage at the input of the inverter. The typical voltage drop across the mains choke is around 4 % at its rated point.



---

Inverters from 22 kW must always be used together with mains chokes.

For operation with the "Light Duty" load characteristic, inverters from 18.5 kW (i550-C11/400-3) must always be used together with mains chokes.

---

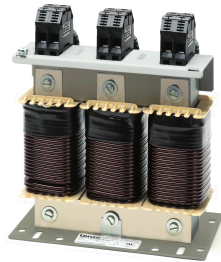

---

The adapted assignment of these accessories and the technical data are provided with the devices.

---



---

## RFI filters / Mains filters

RFI and mains filters are used to ensure compliance with the EMC requirements of European Standard EN 61800-3. This standard defines the EMC requirements for electrical drive system in various categories.

- RFI filters are capacitive accessory components. RFI filters reduce conducted noise emissions. RFI filters are also called EMC filters.
- Mains filters are a combination of mains choke and RFI filter. Mains filters reduce the conducted noise emission.

### Definition of the environments

(EN 61800-3EN 61800-3)

#### First environment

The first environment comprises residential buildings or locations that are directly connected to a low-voltage system for supplying residential areas.

#### Second environment

The second environment comprises facilities or locations that are not directly connected to a low-voltage system for supplying residential areas.

#### Category C1

Category C1 defines the requirements for drive systems that are intended for the use in the first environment at a rated voltage lower than 1000 V.

The limit values of the EN 61800-3EN 61800-3 comply with EN 55011 class B.

#### Category C2

Category C2 defines the requirements for permanently installed drive systems that are intended for the use in the first environment at a rated voltage lower than 1000 V. Installation and commissioning must only be carried out by qualified personnel with EMC knowledge.

The limit values of the EN 61800-3EN 61800-3 comply with EN 55011 class A group 1.

#### Category C3

Category C3 defines the requirements for drive systems that are exclusively intended for the use in the second environment at a rated voltage lower than 1000 V.

The limit values of the EN 61800-3EN 61800-3 comply with EN 55011 class A group 2.



When working with stricter line-bound noise emission requirements which cannot be met using the radio interference suppression measures integrated in the inverter, external filters can be used. The filters can be installed below or next to the inverter.

If necessary, the internal filters have to be deactivated when external filters are used. For this purpose, remove the IT screws of the inverters.

---

# Accessories

Power supply units



## Comparison of integrated and external RFI filters

RFI filters	Filter types			
	Integrated in the inverter	External		
		Low Leakage	Short Distance	Long Distance
Use	In standard applications.	In mobile systems.	With short cable length.	At switching frequencies 4 kHz and 8 kHz.
Optimisation	Easy use.	For low leakage current.	For low leakage current.	For long motor cable.
Reduces noise emissions	Cable-guided and radiated	Cable-guided	Cable-guided	Cable-guided



The adapted assignment of these accessories and the technical data are provided with the devices.

## Sine filter

A sinusoidal filter in the motor cable limits the rate of voltage rise and the capacitive charge/discharge currents that occur during inverter operation.



Only use a sinusoidal filter with standard asynchronous motors 0 to 550 V.  
 Operation only with V/f or square-law V/f characteristic control.  
 Set the switching frequency permanently to the specified value.  
 Limit the output frequency of the inverter to the given value.



The adapted assignment of these accessories and the technical data are provided with the devices.

## Power supply units

For the external supply of the control electronics of the inverter.

The parameterisation and diagnostics can be executed when the mains input at the inverter is deenergised.



Order code		EZV1200-000	EZV2400-000	EZV4800-000	EZV1200-001	EZV2400-001	EZV4800-001
Rated voltage	V	230			400		
Rated mains current	A	0.8	1.2	2.3	0.3	0.6	1.0
Input voltage	V	AC 85 - 264 DC 90 ...350			AC 320 ... 575 DC 450 ...800		
Output voltage	V	DC 22.5 - 28.5					
Rated output current	A	5.0	10.0	20.0	5.0	10.0	20.0



## Brake switches

For switching an electromechanical brake.

The brake switch consists of a rectifier and an electronic circuit breaker.

It is mounted on the control cabinet plate by means of two screws. Control is performed using a digital output on the inverter.



Brake switches		Half-wave rectifiers	Bridge rectifiers
Order code		E82ZWBRE	E82ZWBRB
Input voltage	V	AC 320 - 550	AC 180 - 317
Output voltage	V	DC 180 (with AC 400) DC 225 (with AC 500)	DC 205 (with AC 230)
Max. brake current	A	0.61	0.54

# Accessories

Mounting  
Shield mounting kit



## Mounting

### Shield mounting kit

#### Motor cable

If the shielding of the motor cable is centrally connected to an earthing bus in the control cabinet, no shielding is required.

For a direct connection of the shielding of the motor cable to the inverter, the optionally available accessories can be used consisting of shield sheet and fixing clips or wire clamps.



From 15 kW, the shield sheet is integrated.

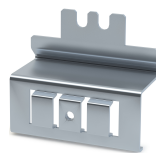

Inverter	Shield mounting kit	
	Order code	VPE
		Piece
i550-C0.25/230-1	EZAMBHXM014/M	5x motor shield sheet 10x fixing clip
i550-C0.25/230-2		
i550-C0.37/230-1		
i550-C0.37/230-2		
i550-C0.55/230-1		
i550-C0.55/230-2		
i550-C0.75/230-1		
i550-C0.75/230-2		
i550-C1.1/230-1		
550-C1.1/230-2		
i550-C1.5/230-1		
i550-C1.5/230-2		
i550-C2.2/230-1		
i550-C2.2/230-2		
i550-C0.37/400-3		
i550-C0.55/400-3		
i550-C0.75/400-3		
i550-C1.1/400-3		
i550-C1.5/400-3		
i550-C2.2/400-3		
i550-C3.0/400-3	EZAMBHXM016/M	5x motor shield sheet 5x fixing clip 5x wire clamp (cable diameter 10 ... 20 mm)
i550-C4.0/400-3		
i550-C5.5/400-3	EZAMBHXM004/M EZAMBHXM005/M	5x wire clamp (cable diameter 15 ... 28 mm) 5x wire clamp (cable diameter 20 ... 37 mm)
i550-C7.5/400-3		
i550-C11/400-3		
i550-C15/400-3		
i550-C18.5/400-3		
i550-C22/400-3		
i550-C30/400-3		
i550-C37/400-3		
i550-C45/400-3		



## Shield mounting of the control cables

In case of the control unit, the shield sheet for control cables is integrated.

Usually, the shields can be fixed with standard plastic cable ties.

Optionally, fixing clips are suitable for the shield connections of the control cables of inverters 0.25 kW ... 0.75 kW.

Shield mounting kit	
Order code	VPE
	Piece
EZAMBHXM007/M	20x fixing clip

## Terminal strips

For connecting the inverter, the connections are equipped with pluggable terminal strips. Pluggable terminal strips are available separately for service purposes or if cable harnesses need to be physically separated.





Inverter	Terminal strips Mains connection X100		Terminal strips Motor connection X105	
	Order code	VPE	Order code	VPE
		Piece		Piece
i550-C0.25/230-1	EZA EVE032/M	10	EZA EVE039/M	5
i550-C0.37/230-1				
i550-C0.55/230-1				
i550-C0.75/230-1				
i550-C1.1/230-1	EZA EVE033/M			
i550-C1.5/230-1				
i550-C2.2/230-1				
i550-C0.25/230-2	EZA EVE034/M	10		
i550-C0.37/230-2				
i550-C0.55/230-2				
i550-C0.75/230-2				
i550-C1.1/230-2	EZA EVE035/M			
i550-C1.5/230-2				
i550-C2.2/230-2				
i550-C0.37/400-3	EZA EVE037/M	5		
i550-C0.55/400-3				
i550-C0.75/400-3				
i550-C1.1/400-3				
i550-C1.5/400-3				
i550-C2.2/400-3				

Terminal strips	Order code	VPE	Terminal strips	Order code	VPE
		Piece			Piece
Safety (STO) X1	EZA EVE029/M	10	Standard I/O X3	EZA EVE040/M	5
Relay X9	EZA EVE030/M	10	Application I/O X3	EZA EVE041/M	5
Motor PTC X109	EZA EVE031/M	10	CANopen / Modbus X216	EZA EVE042/M	10



## Mounting/ installation

More data and information for the mechanical and electrical installation can be found here:

- [Control cabinet structure](#)  41
- [EMC-compliant installation](#)  43
- [Standards and operating conditions](#)  45
- [Dimensions](#)  122



The scope of supply of the inverter comprises mounting instructions. They describe technical data and information on mechanical and electrical installation.

### Mounting position

- Vertical alignment - all mains connections are at the top and the motor connections at the bottom.

### Free spaces

- Maintain the specified free spaces above and below to the other installations.

### Mechanical installation

- The mounting location and material must ensure a durable mechanical connection.
- Do not mount onto DIN rails!
- In case of continuous vibrations or shocks use vibration dampers.

### How to mount the inverters onto the mounting plate

1. Prepare mounting plate with corresponding threaded holes and equip them with screws and, if required, washers.
    - a) Use screw and washer assemblies or hexagon socket screws with washers.
    - b) Do not yet tighten the screws.
  2. Mount the inverter on the prepared mounting plate via keyhole suspension.
  3. Only tighten the screws hand-tight.
  4. If required, pre-assemble further units.
  5. Adjust the units.
  6. Screw the units onto the mounting plate.
- The inverters are ready for wiring.

### Measures for cooling during operation

- Ensure unimpeded ventilation of cooling air and outlet of exhaust air.
- If the cooling air is polluted (fluff, (conductive) dust, soot, aggressive gases), take adequate countermeasures.
  - Install filters.
  - Arrange for regular cleaning of the filters.
- If required, implement a separate air guide.

Screw and washer assemblies or hexagon socket screws with washers are recommended..

M5 x  $\geq$  10 mm for devices up to and including 2.2 kW

M5 x  $\geq$  12 mm for devices up to and including 11 kW

M6 x  $\geq$  16 mm for devices up to and including 22 kW

M8 x  $\geq$  16 mm for devices up to and including 45 kW





## Detecting and eliminating EMC interferences

Trouble	Cause	Remedy
Interferences of analog setpoints of your own or other devices and measuring systems	Unshielded motor cable has been used	Use shielded motor cable
	Shield contact is not extensive enough	Carry out optimal shielding as specified
	Shield of the motor cable is interrupted, e. g. by terminal strips, switches etc.	<ul style="list-style-type: none"> <li>Separate components from other component parts with a minimum distance of 100 mm</li> <li>Use motor chokes or motor filters</li> </ul>
	Additional unshielded cables inside the motor cable have been installed, e. g. for motor temperature monitoring	Install and shield additional cables separately
	Too long and unshielded cable ends of the motor cable	Shorten unshielded cable ends to maximally 40 mm
Conducted interference level is exceeded on the supply side	Terminal strips for the motor cable are directly located next to the mains terminals	Spatially separate the terminal strips for the motor cable from mains terminals and other control terminals with a minimum distance of 100 mm
	Mounting plate varnished	Optimise PE connection: <ul style="list-style-type: none"> <li>Remove varnish</li> <li>Use zinc-coated mounting plate</li> </ul>
	HF short circuit	Check cable routing

A good shield connection at the transitions of the different areas reduce possible interferences caused by problems with the EMC.

### Example of an EMC-compliant cable gland

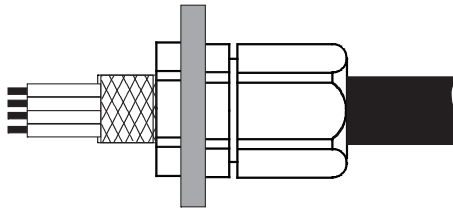

Fig. 2: EMC cable gland with a high degree of protection

# Mounting/ installation

Electrical installation  
Important notes



---

## Electrical installation

### Important notes

#### **DANGER!**

Dangerous electrical voltage

The product's power connections can still be carrying voltage when the mains supply has been switched off.

Possible consequences: Death or severe injuries when touching the power terminals.

- ▶ Do not touch the power connections immediately. Take note of the corresponding warning plates on the product.
  - ▶ Check to make sure that all power connections are deenergised.
- 

#### **DANGER!**

Dangerous electrical voltage

The leakage current against earth (PE) is  $> 3.5$  mA AC or  $> 10$  mA DC.

Possible consequences: Death or severe injuries when touching the device in the event of an error.

- ▶ Implement the measures required in EN 61800-5-1, especially:
  - ▶ Fixed installation
  - ▶ The PE connection must comply with the standards (PE conductor diameter  $\geq 10$  mm<sup>2</sup> or use a double PE conductor)
- 

#### **NOTICE**

No protection against excessively high mains voltage

The mains input is not fused internally.

Possible consequences: Destruction of the product in the event of excessively high mains voltage.

- ▶ Take note of the maximum permissible mains voltage.
  - ▶ On the mains supply side, use fuses to adequately protect the product against mains fluctuations and voltage peaks.
- 

#### **DANGER!**

Use of the inverter on a phase earthed mains with a rated mains voltage  $\geq 400$  V

The protection against accidental contact is not ensured without external measures.

- ▶ If protection against accidental contact according to EN 61800-5-1 is required for the control terminals of the inverters and the connections of the plugged device modules, ...
  - ▶ an additional basic insulation has to be provided.
  - ▶ the components to be connected have to come with a second basic insulation.
-



## NOTICE

Overvoltage at devices with 230-V mains connection

An impermissible overvoltage may occur if the central supply of the N conductor is interrupted if the devices are connected to a TN three-phase system.

Possible consequences: Destruction of the device

- ▶ Provide for the use of isolating transformers.

## NOTICE

The product contains electrostatic sensitive devices.

Possible consequences: Destruction of the device

- ▶ Before working in the connection area, the staff must ensure to be free of electrostatic charge.

## NOTICE

Pluggable terminal strips or plug connections

Plugging or removing the terminal strips or plug connections during operation may cause high voltages and arcing.

Possible consequences: Damage of the devices

- ▶ Switch off device.
- ▶ Only plug or remove the terminal strips or plug connections in deenergised status.

## NOTICE

Use of mains filters and RFI filters in IT systems

Mains filters and RFI filters from Lenze contain components that are interconnected against PE.

Possible consequences: The filters may be destroyed when an earth fault occurs.

Possible consequences: Monitoring of the IT system may be triggered.

- ▶ Do not use mains filters and RFI filters from Lenze in IT systems.
- ▶ Before using the inverter in the IT system, remove the IT screws.

## NOTICE

Overvoltage at components

In case of an earth fault in IT systems, intolerable overvoltages may occur in the plant.

Possible consequences: Destruction of the device.

- ▶ Before using the inverter in the IT system, the contact screws must be removed.
- ▶ Positions and number of the contact screws depend on the device.



Ensure a trouble-free operation:

Carry out the total wiring so that the separation of the separate potential areas is preserved.

# Mounting/ installation

Electrical installation  
Important notes



---

When implementing machines and systems for the use in the UL/CSA scope, you have to observe especially issued notes.

These notes and further information on the UL/CSA subject are summarised in separated documents.

---



---

You have to install the devices into housings (e. g. control cabinets) to comply with valid regulations.

Stickers with warning notes must be displayed prominently and close to the device.

---

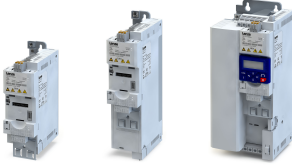

---

### Mains connection

The following should be considered for the mains connection of inverters:

Single inverters are either directly connected to the **AC system** or via upstream filters. RFI filters are already integrated in many inverters. Depending on the requirements, mains chokes or mains filters can be used.

Inverter groups are connected to the **DC system** with the DC bus. For this purpose, the inverters have to be provided with a connection for the DC bus, e. g. terminals +UG/-UG.

This enables the energy exchange in phases with operation in generator and motor mode of several drives in the network.

The DC system can be provided by power supply modules (AC/DC converters) or inverters with a power reserve.

The technical data informs about the possible applications in the given groups. In the dimensioning, data and further notes have to be observed.

# Mounting/ installation

Electrical installation  
Mains connection



## 1-phase mains connection 120 V

### Connection plan

The connection plan is valid for the inverters i550-Cxxx/120-1.



Inverters i550-Cxxx/120-1 do not have an integrated RFI filter in the AC mains supply.

In order to meet the EMC requirements according to EN 61800-3/EN 61800-3, an external EMC filter according to IEC EN 60939/IEC EN 60939 must be used.

The user must verify that the conformity with EN 61800-3/EN 61800-3 is fulfilled.

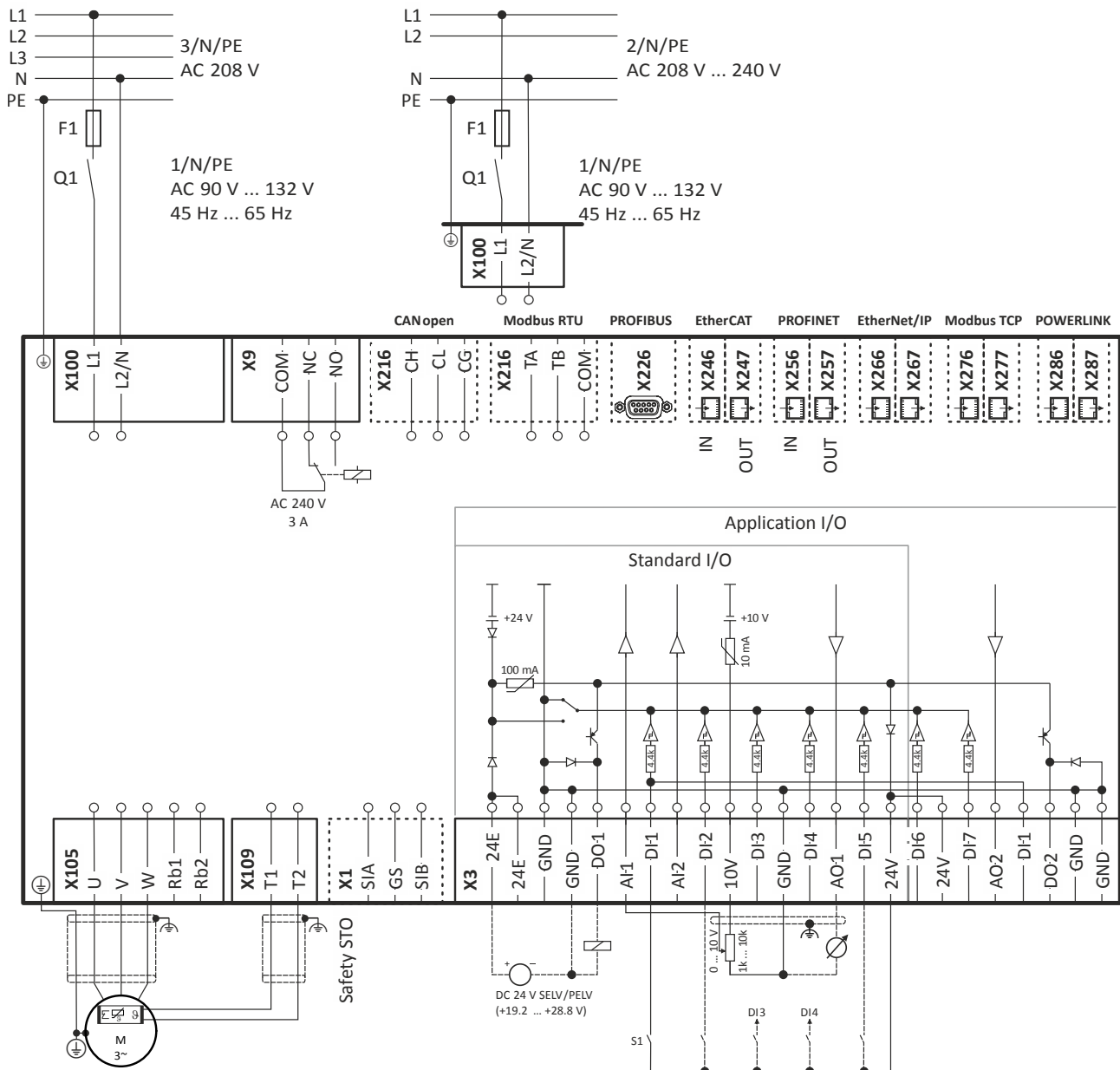

Fig. 3: Wiring example

S1 Start/Stop  
Fx Fuses

Q1 Mains contactor  
--- Dashed line = options



## 1-phase mains connection 230/240 V

### Connection plan

The connection plan is valid for the inverters i550-Cxxx/230-1.

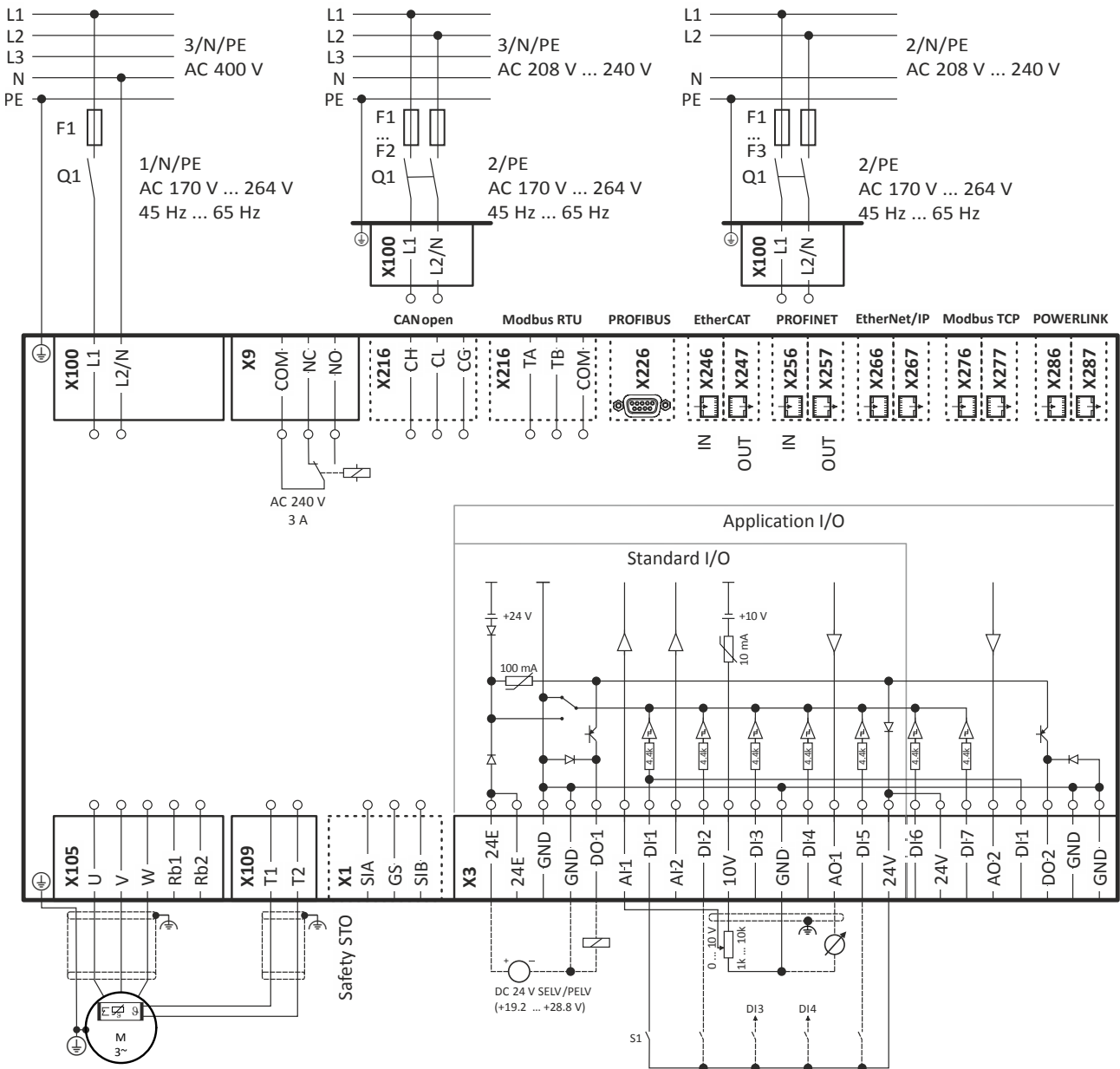

Fig. 4: Wiring example

- S1 Start/Stop
- Fx Fuses

- Q1 Mains contactor
- Dashed line = options

# Mounting/ installation

Electrical installation  
Mains connection



The connection plan is valid for the inverters i550-Cxxx/230-2.



Inverters i550-Cxxx/230-2 do not have an integrated RFI filter in the AC mains supply.

In order to meet the EMC requirements according to EN 61800-3/EN 61800-3, an external EMC filter according to IEC EN 60939/IEC EN 60939 must be used.

The user must verify that the conformity with EN 61800-3/EN 61800-3 is fulfilled.

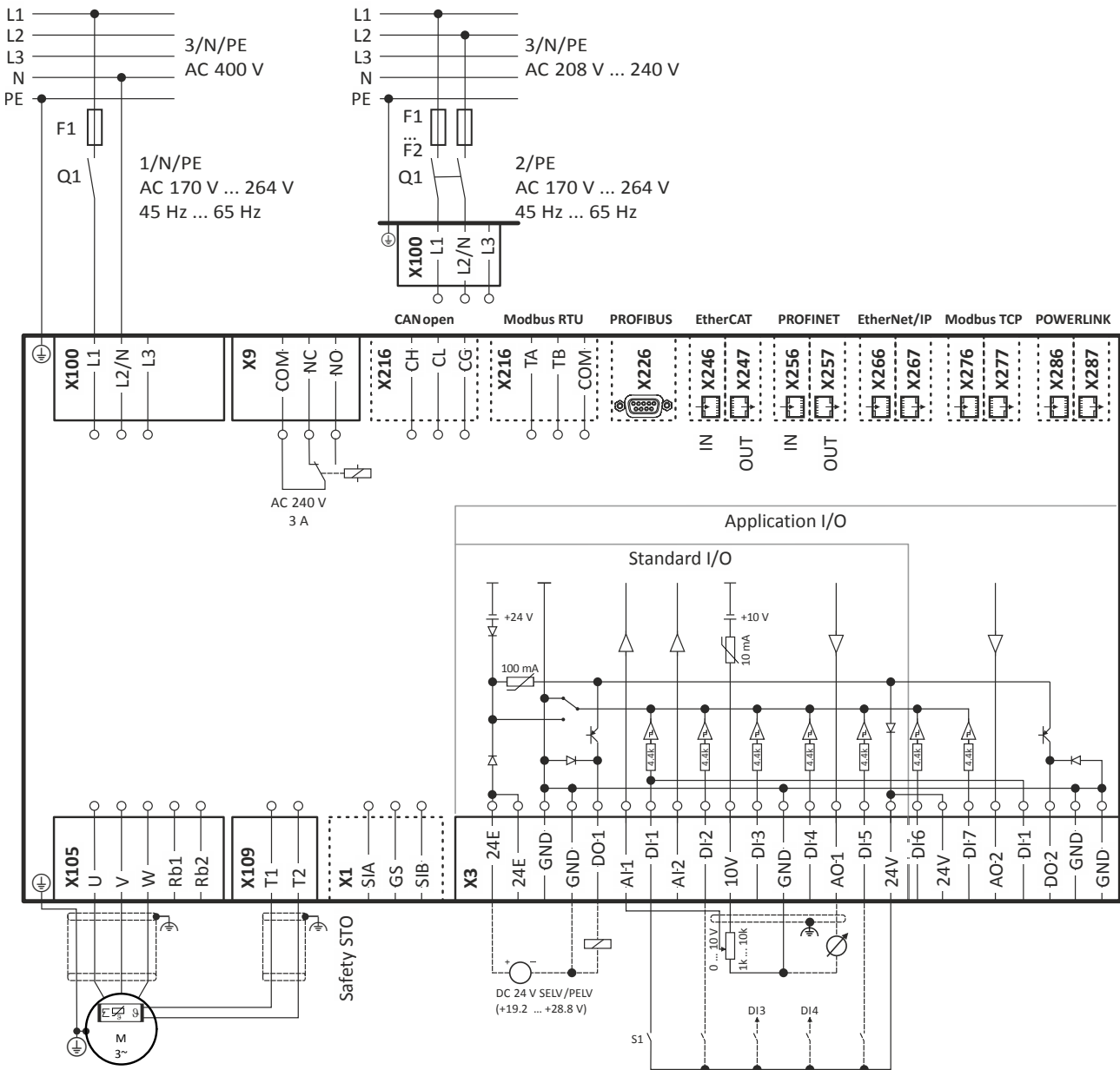
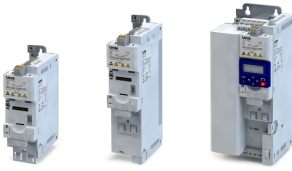

Fig. 5: Wiring example

- S1 Start/Stop
- Fx Fuses

- Q1 Mains contactor
- Dashed line = options





## 3-phase mains connection 230/240 V

### Connection plan

The connection plan is valid for the inverters i550-Cxxx/230-3.



Inverters i550-Cxxx/230-3 do not have an integrated RFI filter in the AC mains supply.

In order to meet the EMC requirements according to EN 61800-3/EN 61800-3, an external EMC filter according to IEC EN 60939/IEC EN 60939 must be used.

The user must verify that the conformity with EN 61800-3/EN 61800-3 is fulfilled.

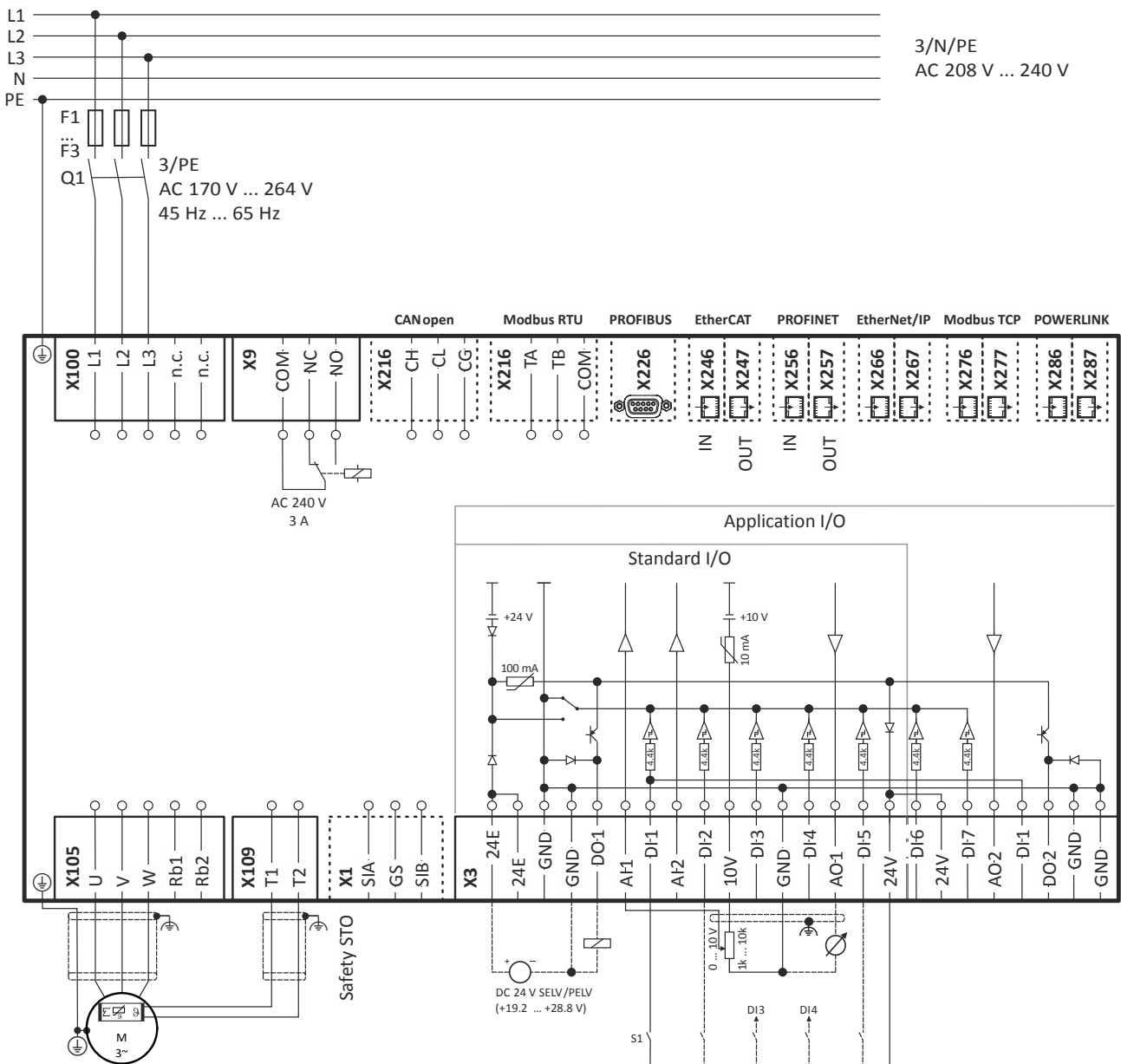

Fig. 6: Wiring example

S1 Start/Stop  
Fx Fuses

Q1 Mains contactor  
--- Dashed line = options

# Mounting/ installation

Electrical installation  
Mains connection



The connection plan is valid for the inverters i550-Cxxx/230-2.



Inverters i550-Cxxx/230-2 do not have an integrated RFI filter in the AC mains supply.

In order to meet the EMC requirements according to EN 61800-3/EN 61800-3, an external EMC filter according to IEC EN 60939/IEC EN 60939 must be used.

The user must verify that the conformity with EN 61800-3/EN 61800-3 is fulfilled.

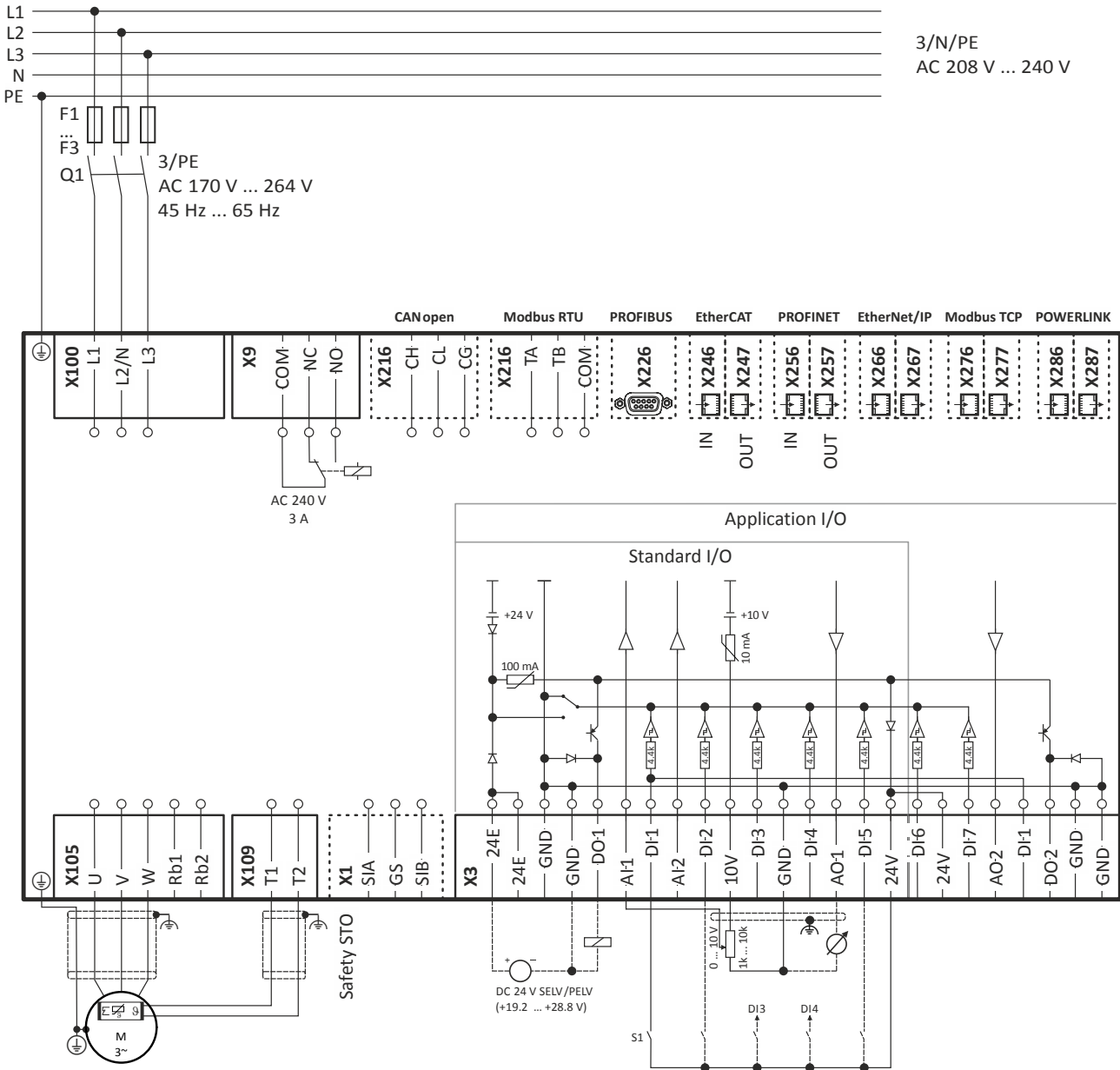
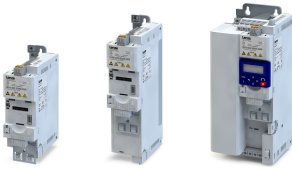

Fig. 7: Wiring example

S1 Start/Stop  
Fx Fuses

Q1 Mains contactor  
--- Dashed line = options



# Mounting/ installation

Electrical installation  
Mains connection

## 3-phase mains connection 400 V

### Connection plan

The connection plan is valid for the inverters i550-Cxxx/400-3.

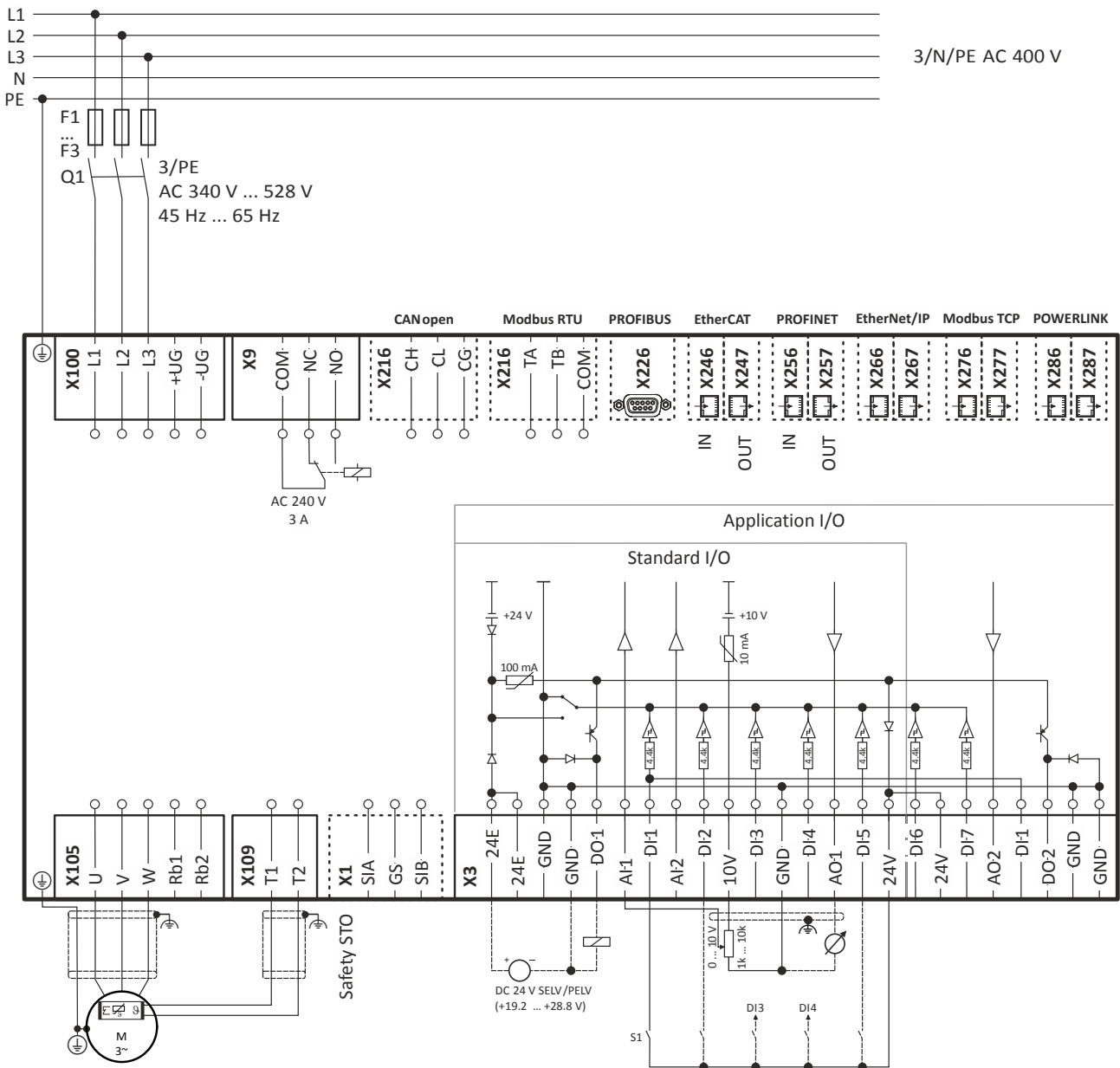

Fig. 8: Wiring example

S1 Start/Stop  
Fx Fuses

Q1 Mains contactor  
--- Dashed line = options

## 3-phase mains connection 400 V "light duty"

### Connection plan

See chapter "3-phase mains connection 400 V". [179](#)

# Mounting/ installation

Electrical installation  
Mains connection



## 3-phase mains connection 480 V

### Connection plan

The connection plan is valid for the inverters i550-Cxxx/400-3.

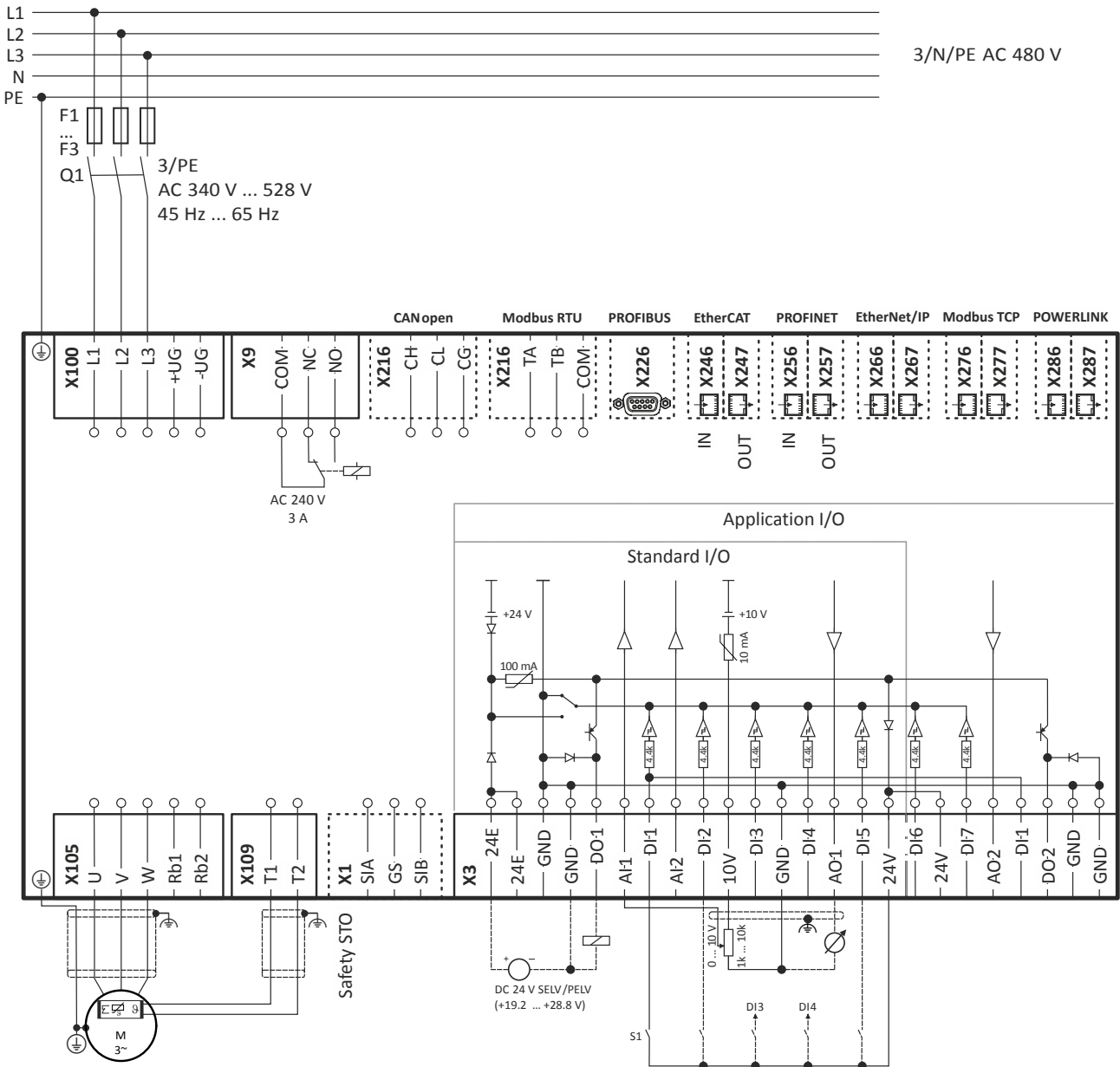

Fig. 9: Wiring example

- S1 Start/Stop
- Fx Fuses

- Q1 Mains contactor
- Dashed line = options

## 3-phase mains connection 480 V "Light Duty"

### Connection plan

See chapter "3-phase mains connection 480 V". [180](#)



## Motor connection

### Motor cable lengths

- The rated data for the motor cable length must be observed.
- Keep the motor cable as short as possible as this has a positive effect on the drive behaviour and the EMC.
- Several motors connected to an inverter form a group drive.  
In case of group drives, the resulting motor cable length  $l_{res}$  is relevant:

$$l_{res} [m] = (l_1 + l_2 + l_3 \dots l_i) \cdot \nu_i$$

$l_{res}$	Resulting length of the motor cables
$l_x$	Length of the single motor cable
$i$	Number of the single motor cables

### Shielding

A good shield connection and short cable lengths reduce possible interferences caused by problems with the EMC.

#### Example for preparing the EMC-compliant wiring or the motor cable

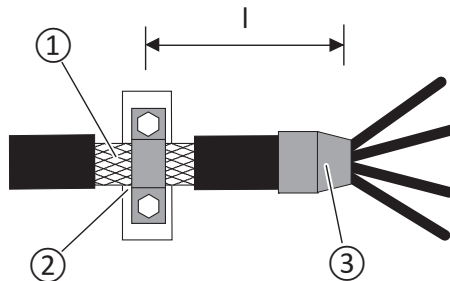

Fig. 10: Shield connection

- |   |                                       |     |                      |
|---|---------------------------------------|-----|----------------------|
| ① | Braid                                 | ③   | Heat-shrinkable tube |
| ② | large surface contacting of the braid | $l$ | maximally 500 mm     |

### Switching in the motor cable



Switching on the motor side of the inverter is permissible:

For safety shutdown (emergency stop).

In case several motors are driven by one inverter (only in V/f operating mode).

Please note the following:

The switching elements on the motor side must be dimensioned for with the maximum occurring load.

### Connection of motor temperature monitoring



If the terminal X109 is used, e. g. to connect an external PTC thermistor (PTC) or a thermal contact, ensure at least one basic insulation to the potentials of motor, mains and control terminals to not restrict the protective separation of the control terminals.

# Mounting/ installation

Electrical installation  
Brake resistor connection

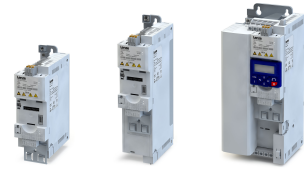

## Brake resistor connection

If wiring of the brake resistor can be kept short, it is sufficient to twist the cables. Up to 0.5 m of cable length, this applies to the cable of the brake resistor and the cable of temperature monitoring. This procedure reduces interferences caused by problems with the EMC.

### Cables for a brake resistor - short version

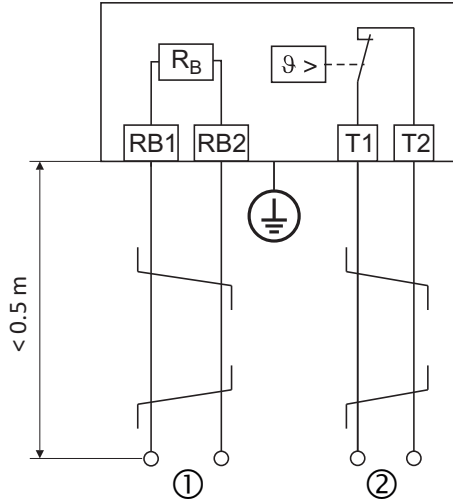

Fig. 11: Connection plan - brake resistor with a cable length of up to 0.5 m

- ① For the connection of the "brake resistor" to the inverter or another component with brake chopper
- ② For a control contact, e.g. digital input that is set to the monitoring mode of the thermal contact

If wiring of the brake resistor cannot be kept short, a shielded cable is required. The cable of the brake resistor shall not exceed a length of 5 m.

For the cable of temperature monitoring, twisting is sufficient. This procedure reduces interferences caused by problems with the EMC.

### Cables for a brake resistor - long version

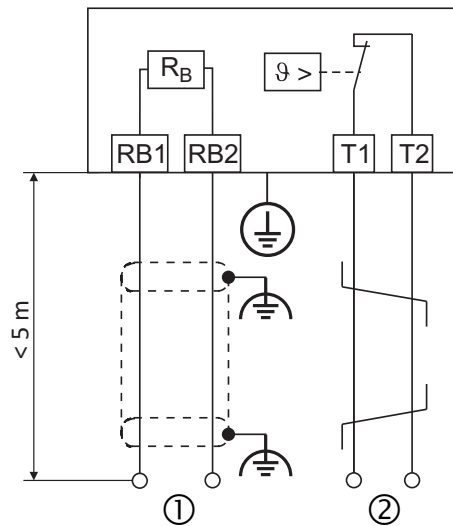

Fig. 12: Connection plan - brake resistor with a cable length of up to 5 m

- ① For the connection of the "brake resistor" to the inverter or another component with brake chopper
- ② For a control contact, e.g. digital input that is set to the monitoring mode of the thermal contact



## Control connections



In order to achieve an optimum shielding effect (in case of very long cables, with high interference), one shield end of analog input and output cables can be connected to PE potential via a capacitor (e. g. 10 nF/250 V).

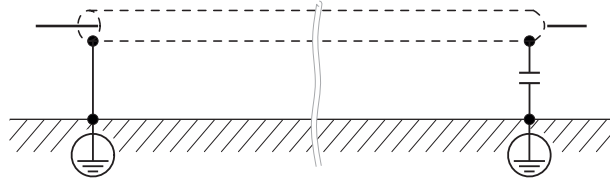

# Purchase order

Notes on ordering





## Purchase order

### Notes on ordering

There are two ways to order an inverter.

As a complete inverter or as single components consisting of power unit, control unit and safety module.

Complete inverter	Inverter consisting of components
	 <p>Power unit</p> <p>Control unit</p> <p>Safety module</p>



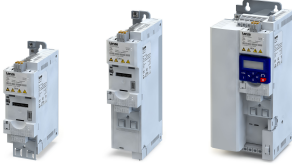

---

## Order code

### Delivery as complete inverter

If always the same inverter is used in the machine the inverter can be ordered "out of the box".

Order data: Order code of the complete device.

### Order example

Description of the component	Order code
Complete inverter	i55AE222F1AV10002S
3-phase mains connection 400 V	
Power 2.2 kW (i550-C2.2/400-3)	
Safety engineering: STO safety function	
Default setting of parameters: EU region (50-Hz systems)	
Standard I/O with CANopen	

# Purchase order

Order code



Complete inverter			
Performance		Inverter	Order code
kW	HP		
1-phase mains connection 120 V, EMC filter not integrated			
0.25	0.33	i550-C0.25/120-1	i55AE125A1
0.37	0.5	i550-C0.37/120-1	i55AE137A1
0.75	1	i550-C0.75/120-1	i55AE175A1
1.1	1.5	i550-C1.1/120-1	i55AE211A1
1-phase mains connection 230 V, EMC filter integrated			
0.25	0.33	i550-C0.25/230-1	i55AE125B1
0.37	0.5	i550-C0.37/230-1	i55AE137B1
0.55	0.75	i550-C0.55/230-1	i55AE155B1
0.75	1	i550-C0.75/230-1	i55AE175B1
1.1	1.5	i550-C1.1/230-1	i55AE211B1
1.5	2	i550-C1.5/230-1	i55AE215B1
2.2	3	i550-C2.2/230-1	i55AE222B1
1/3-phase mains connection 230/240 V, EMC filter not integrated			
0.25	0.33	i550-C0.25/230-2	i55AE125D1
0.37	0.5	i550-C0.37/230-2	i55AE137D1
0.55	0.75	i550-C0.55/230-2	i55AE155D1
0.75	1	i550-C0.75/230-2	i55AE175D1
1.1	1.5	i550-C1.1/230-2	i55AE211D1
1.5	2	i550-C1.5/230-2	i55AE215D1
2.2	3	i550-C2.2/230-2	i55AE222D1
3-phase mains connection 230/240 V, EMC filter not integrated			
4.0	5	i550-C4.0/230-3	i55AE240C1
5.5	7.5	i550-C5.5/230-3	i55AE255C1
3-phase mains connection 400/480 V, EMC filter integrated			
0.37	0.5	i550-C0.37/400-3	i55AE137F1
0.55	0.75	i550-C0.55/400-3	i55AE155F1
0.75	1	i550-C0.75/400-3	i55AE175F1
1.1	1.5	i550-C1.1/400-3	i55AE211F1
1.5	2	i550-C1.5/400-3	i55AE215F1
2.2	3	i550-C2.2/400-3	i55AE222F1
3	4	i550-C3.0/400-3	i55AE230F1
4	5	i550-C4.0/400-3	i55AE240F1
5.5	7.5	i550-C5.5/400-3	i55AE255F1
7.5	10	i550-C7.5/400-3	i55AE275F1
11	15	i550-C11/400-3	i55AE311F1
15	20	i550-C15/400-3	i55AE315F1
18.5	25	i550-C18/400-3	i55AE318F1
22	30	i550-C22/400-3	i55AE322F1
30	40	i550-C30/400-3	i55AE330F1
37	50	i550-C37/400-3	i55AE337F1
45	60	i550-C45/400-3	i55AE345F1
55	74	i550-C55/400-3	i55AE355F1
75	100	i550-C75/400-3	i55AE375F1
Continuation ...			



Complete inverter			
Performance		Inverter	Order code
kW	HP		
<i>Continuation ...</i>			
Safety engineering			
Without safety engineering		0	
Safety function STO		A	
not relevant		V	
EMC filter			
not integrated i550-Cxxx/ 120-1 i550-Cxxx/ 230-2 i550-Cxxx/ 230-3		0	
Integrated i550-Cxxx/ 230-1 i550-Cxxx/ 400-3		1	
Delivery status			
Default setting of parameters: EU region (50-Hz systems)		0	
Default setting of parameters: US region (60-Hz systems)		1	
Control unit			
Standard I/O without network		000S	
Application I/O without network		001S	
Standard I/O with CANopen		002S	
Standard I/O with Modbus RTU		003S	
Standard I/O with Modbus TCP		00WS	
Standard I/O with PROFIBUS		004S	
Standard I/O with EtherCAT		00KS	
Standard I/O with PROFINET		00LS	
Standard I/O with EtherNet/IP		00MS	
Standard I/O with POWERLINK		012S	

### Delivery of individual components

If different product versions are required in the machine, the various components can be ordered individually. Depending on the application, the components can be plugged together easily an without any further tools.

Order data: Order codes of the individual components.

### Order example

Description of components	Order code
Power unit	I5DAE222F10V10000S
3-phase mains connection 400/480 V	
Power 2.2 kW (i550-C2.2/400-3)	
Safety module	I5MASAV000000S
Control unit	I5CA5C02000VA0000S
Standard I/O with CANopen	
Default setting of parameters: EU region (50-Hz systems)	

# Purchase order

Order code



Power unit			
Performance		Inverter	Order code
kW	HP		
1-phase mains connection 120 V, EMC filter not integrated			
0.25	0.33	i550-C0.25/120-1	I5DAE125A10V00000S
0.37	0.5	i550-C0.37/120-1	I5DAE137A10V00000S
0.75	1	i550-C0.75/120-1	I5DAE175A10V00000S
1.1	1.5	i550-C1.1/120-1	I5DAE211A10V00000S
1-phase mains connection 230 V, EMC filter integrated			
0.25	0.33	i550-C0.25/230-1	I5DAE125B10V10000S
0.37	0.5	i550-C0.37/230-1	I5DAE137B10V10000S
0.55	0.75	i550-C0.55/230-1	I5DAE155B10V10000S
0.75	1	i550-C0.75/230-1	I5DAE175B10V10000S
1.1	1.5	i550-C1.1/230-1	I5DAE211B10V10000S
1.5	2	i550-C1.5/230-1	I5DAE215B10V10000S
2.2	3	i550-C2.2/230-1	I5DAE222B10V10000S
1/3-phase mains connection 230/240 V, EMC filter not integrated			
0.25	0.33	i550-C0.25/230-2	I5DAE125D10V00000S
0.37	0.5	i550-C0.37/230-2	I5DAE137D10V00000S
0.55	0.75	i550-C0.55/230-2	I5DAE155D10V00000S
0.75	1	i550-C0.75/230-2	I5DAE175D10V00000S
1.1	1.5	i550-C1.1/230-2	I5DAE211D10V00000S
1.5	2	i550-C1.5/230-2	I5DAE215D10V00000S
2.2	3	i550-C2.2/230-2	I5DAE222D10V00000S
3-phase mains connection 230/240 V, EMC filter not integrated			
4.0	5	i550-C4.0/230-3	I5DAE240C10V00000S
5.5	7.5	i550-C5.5/230-3	I5DAE255C10V00000S
3-phase mains connection 400/480 V, EMC filter integrated			
0.37	0.5	i550-C0.37/400-3	I5DAE137F10V10000S
0.55	0.75	i550-C0.55/400-3	I5DAE155F10V10000S
0.75	1	i550-C0.75/400-3	I5DAE175F10V10000S
1.1	1.5	i550-C1.1/400-3	I5DAE211F10V10000S
1.5	2	i550-C1.5/400-3	I5DAE215F10V10000S
2.2	3	i550-C2.2/400-3	I5DAE222F10V10000S
3	4	i550-C3.0/400-3	I5DAE230F10V10000S
4	5	i550-C4.0/400-3	I5DAE240F10V10000S
5.5	7.5	i550-C5.5/400-3	I5DAE255F10V10000S
7.5	10	i550-C7.5/400-3	I5DAE275F10V10000S
11	15	i550-C11/400-3	I5DAE311F10V10000S
15	20	i550-C15/400-3	I5DAE315F10V10000S
18.5	25	i550-C18/400-3	I5DAE318F10V10000S
22	30	i550-C22/400-3	I5DAE322F10V10000S
30	40	i550-C30/400-3	I5DAE330F10V10000S
37	50	i550-C37/400-3	I5DAE337F10V10000S
45	60	i550-C45/400-3	I5DAE345F10V10000S
55	74	i550-C55/400-3	I5DAE355F10V10000S
75	100	i550-C55/400-3	I5DAE375F10V10000S
<b>Safety module</b>			<b>Order code</b>
Safety function STO			I5MASAV000000S



# Purchase order

Order code

Control unit	Order code	
	Delivery status Default setting of parameters: EU region (50-Hz systems)	Delivery status Default setting of parameters: US region (60-Hz systems)
Standard I/O without network	I5CA5002000VA0000S	I5CA5002000VA1000S
Application I/O without network	I5CA5003000VA0000S	I5CA5003000VA1000S
Standard I/O with CANopen	I5CA5C02000VA0000S	I5CA5C02000VA1000S
Standard I/O with Modbus RTU	I5CA5W02000VA0000S	I5CA5W02000VA1000S
Standard I/O with Modbus TCP	I5CA5V02000VA0000S	I5CA5V02000VA1000S
Standard I/O with PROFIBUS	I5CA5P02000VA0000S	I5CA5P02000VA1000S
Standard I/O with EtherCAT	I5CA5T02000VA0000S	I5CA5T02000VA1000S
Standard I/O with PROFINET	I5CA5R02000VA0000S	I5CA5R02000VA1000S
Standard I/O with EtherNet/IP	i5CA5G02000VA0000S	I5CA5G02000VA1000S
Standard I/O with POWERLINK	I5CA5N02000VA0000S	I5CA5N02000VA1000S



## Appendix

### Good to know

#### Approvals/directives

CCC	China Compulsory Certification documents the compliance with the legal product safety requirements of the PR of China - GB standards.
c <sub>CSA</sub> <sub>US</sub>	CSA certificate, tested according to US and Canada standards
CE	Communauté Européenne documents the declaration of the manufacturer that EC Directives are complied with.
CEL	China Energy Label documents the compliance with the legal energy efficiency requirements for motors, tested according to PR of China standards
CSA	Canadian Standards Association CSA certificate, tested according to Canada standards
UL <sup>Energy</sup> <sub>US CA</sub>	Energy Verified Certificate Determining the energy efficiency according to CSA C390 for products within the scope of energy efficiency requirements in the USA and Canada
c <sub>UL</sub> <sub>US</sub>	UL certificate for products, tested according to US and Canada standards
c <sub>UR</sub> <sub>US</sub>	UL certificate for components, tested according to US and Canada standards
EAC	Customs union Russia / Belarus / Kazakhstan certificate documents the declaration of the manufacturer that the specifications for the Eurasian conformity (EAC) required for placing electronic and electromechanical products on the market of the entire territory of the Customs Union (Russia, Belarus, Kazakhstan) are complied with.
UL	Underwriters Laboratory Listed Product
UR	UL certificate for components, tested according to US standards



### Operating modes of the motor

Operating modes S1 ... S10 as specified by EN 60034-1 describe the basic stress of an electrical machine.

In continuous operation a motor reaches its permissible temperature limit if it outputs the rated power dimensioned for continuous operation. However, if the motor is only subjected to load for a short time, the power output by the motor may be greater without the motor reaching its permissible temperature limit. This behaviour is referred to as overload capacity.

Depending on the duration of the load and the resulting temperature rise, the required motor can be selected reduced by the overload capacity.

### The most important operating modes

Continuous operation S1	Short-time operation S2
<p>Operation with a constant load until the motor reaches the thermal steady state. The motor may be actuated continuously with its rated power.</p>	<p>Operation with constant load; however, the motor does not reach the thermal steady state. During the following standstill, the motor winding cools down to the ambient temperature again. The increase in power depends on the load duration.</p>
Intermittent operation S3	Non-intermittent periodic operation S6
<p>Sequence of identical duty cycles comprising operation with a constant load and subsequent standstill. Start-up and braking processes do not have an impact on the winding temperature. The steady-state is not reached. The guide values apply to a cycle duration of 10 minutes. The power increase depends on the cycle duration and on the load period/downtime ratio.</p>	<p>Sequence of identical duty cycles comprising operation with a constant load and subsequent no-load operation. The motor cools down during the no-load phase. Start-up and braking processes do not have an impact on the winding temperature. The steady-state is not reached. The guide values apply to a cycle duration of 10 minutes. The power increase depends on the cycle duration and on the load period/idle time ratio.</p>

P      Power  
t      Time  
 $t_L$     Idle time  
 $\vartheta$      Temperature

$P_V$     Power loss  
 $t_B$     Load period  
 $t_S$     Cycle duration

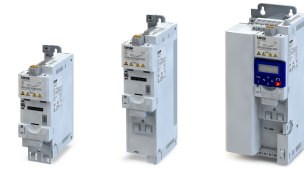

**Motor control types**

The inverter provides various motor control types.

**Linear V/f characteristic control**

The output voltage is increased proportionately to the output frequency.

In case of low output frequencies, the motor voltage can be increased to ensure a minimum current for the breakaway torque. In the field weakening range, the output voltage of the inverter is constant (mains voltage) and the frequency can be further increased depending on the load. The maximum torque of the motor is reduced squaredly to the frequency increase. the maximum output power of the motor being constant.

Application areas are for instance: Single drives with constant load.

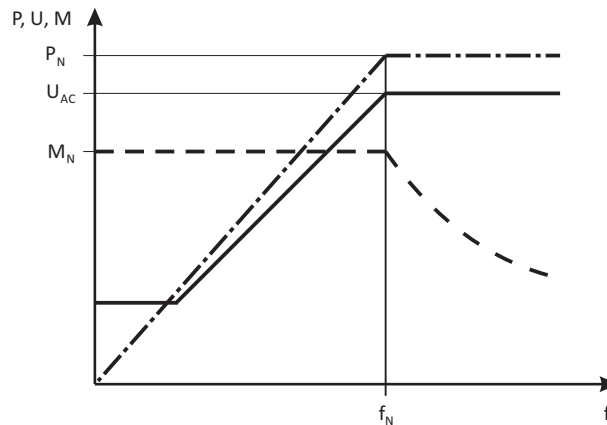

P	Power	$M_{rated}$	Rated torque
V	Voltage	$f_{rated}$	Rated frequency
M	Torque	$M_{rated}$	Rated torque
f	Frequency	$f_{rated}$	Rated frequency

**Square-law V/f characteristic control**

The output voltage is increased squaredly to the output frequency.

In case of low output frequencies, the motor voltage can be increased to ensure a minimum current for the breakaway torque. In the field weakening range, the output voltage of the inverter is constant (mains voltage) and the frequency can be further increased depending on the load. The maximum torque of the motor is reduced squaredly to the frequency increase. the maximum output power of the motor being constant.

Application areas are for instance:

- Pumps
- Fans
- Fan



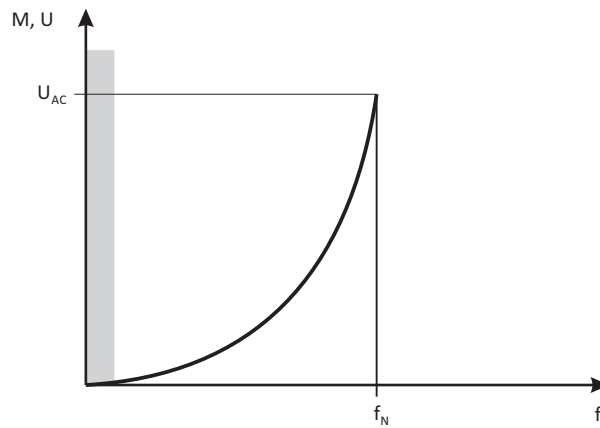

V	Voltage	$U_{AC}$	Mains voltage
f	Frequency	$f_{rated}$	Rated frequency
M	Torque		

### VFCeco

The VFCeco mode has a special effect in the partial load operational range. Usually, three-phase AC motors are supplied there with a higher magnetising current than required by the operating conditions. The VFCeco mode reduces the losses in the partial load operational range so that savings up to 30 % are possible.

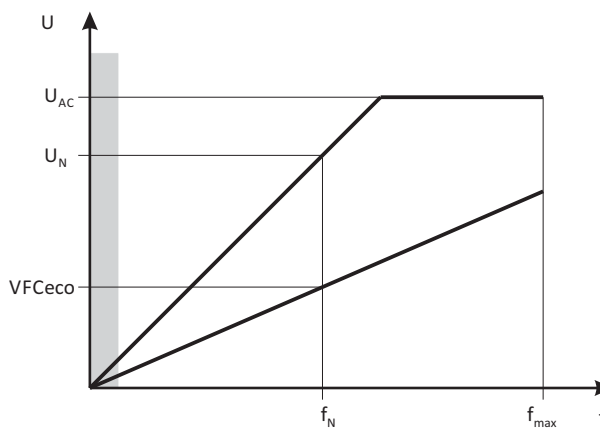

V	Voltage	f	Frequency
$U_{AC}$	Mains voltage	$f_{rated}$	Rated frequency
$U_{rated}$	Rated voltage	$f_{max}$	Max. frequency

### Sensorless vector control (SLVC)

In vector control, an inverted voltage model is used for calculation. The parameters are detected via a parameter identification. The inverter determines the angle between current and voltage. This imposes a current on the motor".

Compared to the V/f characteristic control, the vector control serves to achieve improved drive characteristics thanks to:

- higher torque throughout the entire speed range
- higher speed accuracy and higher concentricity factor
- higher efficiency

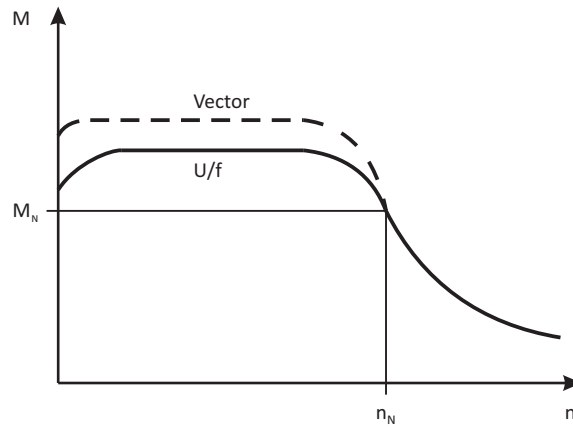

M Torque  $M_{rated}$  Rated torque  
 n Speed  $n_{rated}$  Rated speed

Application areas are for instance:

- Single drives with changing loads
- Single drives with high starting duty
- Sensorless speed control of three-phase AC motors

**Switching frequencies**

On an inverter, the term "switching frequency" is understood to mean the frequency with which the input and outputs of the output module (inverter) are switched. On an inverter, the switching frequency can generally be set to values between 2 and 16 kHz, whereby the selection is based on the respective power output

As switching the modules cause heat losses, the inverter can provide higher output currents at low switching frequencies than at high frequencies. Additionally, it is distinguished between the operation at a permanently set switching frequency and a variably set switching frequency. Here, the switching frequency is automatically reduced as a function of the device utilisation.

At a higher switching frequency, the noise generation is less.

Features	Versions
Switching frequencies	<ul style="list-style-type: none"> <li>• 2 kHz</li> <li>• 4 kHz</li> <li>• 8 kHz</li> <li>• 16 kHz</li> <li>• variable (automatic adjustment)</li> </ul>



## Enclosures

The degree of protection indicates the suitability of a motor for specific ambient conditions with regard to humidity as well as the protection against contact and the ingress of foreign particles. The degrees of protection are classified by EN 60529.

The first code number after the code letters IP indicates the protection against the ingress of foreign particles and dust. The second code number refers to the protection against the ingress of humidity.

Code number 1	Degree of protection	Code number 2	Degree of protection
0	No protection	0	No protection
1	Protection against the ingress of foreign particles $d > 50$ mm. No protection in case of deliberate access.	1	Protection against vertically dripping water (dripping water).
2	Protection against medium-sized foreign particles, $d > 12$ mm, keeping away fingers or similar.	2	Protection against diagonally falling water (dripping water), $15^\circ$ compared to normal service position.
3	Protection against small foreign particles $d > 2.5$ mm. Keeping away tools, wires or similar.	3	Protection against spraying water, up to $60^\circ$ to the vertical
4	Protection against granular foreign particles, $d > 1$ mm, keeping away tools, wire or similar.	4	Protection against spraying water from all directions.
5	Protection against dust deposits (dust-protected), complete protection against contact.	5	Protection against water jets from all directions.
6	Protection against the ingress of dust (dust-proof), complete protection against contact.	6	Protection against choppy seas or heavy water jets (flood protection).

